

Applications

Collection of solutions by KNAUER



Analytical/Preparative HPLC • FPLC • SMB • Osmometry • Sample preparation

KNAUER Applications



Bio sciences

The scope of these applications covers a wide area of bio and life sciences tasks. Biomolecules like proteins, peptides and nucleotides are analyzed by HPLC or UHPLC for their purity and /or concentration. Another application focus is the purification of proteins in a native usable condition. These applications are also referred to as FPLC.



Chemical analysis

For applications in the field of chemical analysis, various separation mechanisms are used. Depending on the properties of the substances and the challenge of the separation, gel permeation chromatography, ion pair chromatography, reversed phase, or chiral is used in the separation mode."



Environmental

Environmental applications cover a wide range of application areas. Prior pollutants, pesticides or PAH's are determined with different HPLC techniques from analytical up to preparative.



Food, feed and beverages

Working with innovative technologies we develop separation and analytical methods, for example determination of mycotoxins in food and feed, separation of additives in soft drinks or determination of osmolality of isotonic and non-isotonic beverages.



Pharmaceutical

In pharmaceutical industry, HPLC plays an important and critical role in the analysis of compounds. It is used in quality control to test compounds for purity and to perform qualitative and quantitative analysis. Another important field is pharmaceutical research and development where target molecules are identified and analyzed by chromatography.



Special applications

Special applications emphasize special features of KNAUER products or other topics with a more technical focal point.

KNAUER Applications

Table of Contents

Bio sciences

VBS0063	Automated two step purification of mouse antibody IgG1	1
VBS0064	Comparison of IgG purification with two different protein A media	5
VBS0066	Fast and sensitive size exclusion chromatography of IgG antibody	9
VBS0067	Automated two-step purification of 6xHis-tagged GFP with AZURA® Bio purification system	13
VBS0069	Purification of Sulphydryl Oxidase	17
VBS0070	Ion Exchange Chromatography with AZURA® Bio purification system	21
VBS0071	Comparison of two column sets for antibody purification in an automated two step purification process. ...	25
VBS0072	Separation of proteins with cation exchange chromatography on Sepapure SP and CM	29
VBS0073	Separation of proteins with anion exchange chromatography on Sepapure Q and DEAE	33
VBS0074	Comparison of ion exchange columns	37
VBS0075	Group separation with Sepapure Desalting on AZURA® Bio purification system	41

Chemical analysis

VCH0015	Quantitative determination of primary aromatic amines in recycled cold-cure and flexible foams	45
VCH0016	Determination and quantification of acrylic acid derivatives	49

Environmental

VEV0078
Systematic HPLC method development and robustness Evaluation of 13 Carbonyl DNPH derivatives Using DryLab® 53

VEV0079
Determination of aromatic hydrocarbon types according to the DIN EN 12916:2016 57

VEV0080
Determination of mono- and polyaromatic hydrocarbons in diesel fuels with AZURA® Analytical HPLC system using RI detection 61

VEV0081
GPC vs. SPE and subsequent determination of polycyclic aromatic hydrocarbons using GC/MS. 65

VEV0082
GPC cleanup method for soil samples before PAHs analysis 69

VEV0083
Sensitive and selective analysis of wood sugars and uronic acids for biofuel research with electrochemical detection 73

Food, feed and beverages

VFD0146
Sensitive online SPE determination of bisphenol A in water samples 77

VFD0150
Alternative xylitol extraction via hplc purification from fermented biomass 81

VFD0152
Determination of Aflatoxin M1 in milk 85

VFD0153
GPC cleanup of olive oil samples. 89

VFD0155
Semi preparative xylitol purification with dedicated sugar purification system 93

VFD0156
Determination of osmolality of isotonic and non-isotonic beverages 97

VFD0157
Simulated Moving Bed (SMB) – a powerful tool for continuous purification of xylitol. 101

VFD0158
Zearalenone and its major metabolites – a simple isocratic method 105

Food, feed and beverages

VFD0159
 Alternaria alternata - determination of main metabolites 109

VFD0160
 Determination of sugars and natural sugar substitutes in different matrices 113

VFD0161
 Determination of sugars in honey using HILIC separation and RI detection. 117

VFD0162
 Separation of ascorbic acid and vitamin B complexes - essentially required nutrients 121

VFD0165
 Natural or artificial? - Determination of vanillin in vanilla products and associated marker substances. 125

VFD0166
 LC-FLD analysis of 4 PAHs in olive oil samples using AZURA® GPC Cleanup System 129

VFD0168
 Oh so sweet - Quantification of steviol glycosides in Stevia samples with RP-HPLC 133

VFD0170
 Scale-up of an analytical HPLC method
 for steviol glycosides to a preparative approach. 141

VFD0172
 A D E K - Easy separation of fat-soluble vitamins using GPC/SEC 145

VFD0171
 Advantages of preparative online SPE compared to batch LC for stevia purification 149

VFD0173
 Be(e) wary - determination of neonicotinoid insecticides in honey 153

VFD0175
 Verification of the mycotoxin patulin from apple juice with isocratic HPLC 161

VFD0177
 Purification of epigallocatechin gallate and other related polyphenols from green tea by mass-triggered
 fractionation 165

VFD0178
 Quick and easy determination of aflatoxins in food matrices with photochemical post column derivatization ... 169

Pharmaceutical

VPH0064
Quality control of pharmaceutical solutions by determination of osmolality **177**

VPH0065
Traditional Chinese Medicine meets modern analytics - HPLC fingerprinting for the comparison of Radix Paeonia alba and Radix Paeonia rubra **181**

VPH0066
Cyclodextrin purification (Part 1): Method screening and overload studies **185**

VPH0067
Easy and fast isolation of rosmarinic acid from lemon balm with mass-directed purification **189**

VPH0068
Cyclodextrin purification (Part 2): Method transfer and purification. **193**

Special applications

VSP0013
Simplified scale up for sugars with the AZURA® RID 2.1 Extended dynamic range option. **197**

VSP0014
Column choice based on Tanaka characterization - not all C18 columns are the same **201**

VSP0016
Quantification of caffeine with the AZURA® Educational system and Mobile Control Software. **205**

VSP0017
Quantification of caffeine with the AZURA® Educational system and ClarityChrom software **209**

VSP0018
Preparation of calibration and samples for the quantification of caffeine with the AZURA® Educational system . . . **213**

Automated two step purification of mouse antibody IgG1

Yannick Krauke, Kate Monks; applications@knauer.net

KNAUER Wissenschaftliche Geräte GmbH, Hegauer Weg 38, 14163 Berlin; www.knauer.net

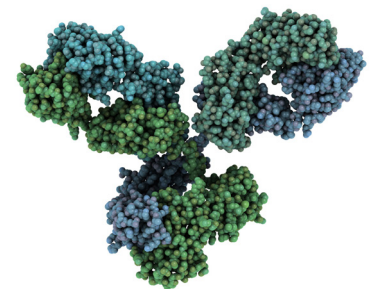

SUMMARY

This application highlights the possibility of automated purification of antibodies (IgG) with the AZURA® Bio purification system without manual interaction during purification process. The cell culture was applied with a feeding pump on a protein A affinity column to capture and purify the antibodies. These were kept in the system and in a second step applied on a gel filtration column for buffer exchange. Consequently, the obtained antibody was dissolved in the desired storage and/or working buffer.

INTRODUCTION

Antibodies (immunoglobulins, Ig's) are part of the immune system. They can identify and bind particular antigens thereby neutralizing them. Due to their specific target recognition/binding function they have a significant importance in the biotechnology and pharmaceutical industry. Key applications are the diagnosis and treatment of diseases. Besides, antibodies are also the crucial components in numerous research applications such as Western Blots and immunoassays. Quality and purity of the IgG is crucial

for these applications. The purification of antibodies involves two to three steps, 1. capture step, (2. intermediate step), 3. polishing step. The transition from one to another step generally involves manual interaction and thus is time consuming. The aim of this application note was to establish an automated purification method on the AZURA Bio purification system combining an affinity chromatography step with a gel filtration/desalting step to exchange the buffer of the purified antibodies.



Automated two step purification of mouse antibody IgG1

RESULTS

The mouse immunoglobulin (IgG1) was purified from 10 mL cell culture by affinity chromatography, using a protein A column. The chromatogram of the IgG purification shows the four main phases of the procedure (Fig.1). Phase 1: equilibration of the protein A column with buffer A. Phase 2: sample injection by the feed pump. The large flow through peak (A) visualizes the cell culture matrix and proteins not bound by the protein A column. Subsequently, the column was washed with buffer A until no further peaks were detected. Phase 3: elution of the captured IgG1 with buffer B and parking in the sample loop (B1). Phase 4: immediate buffer exchange was performed by the flushing of the system with exchange buffer C and the following re-injection of the IgG1 on the desalting column. The eluting peak was recovered by the fraction collector (B2). The main aim of the second

step was the buffer exchange. The conductivity signal was recorded, demonstrating the desalting of the eluates during the purification process (Fig. 2). Finally, a SDS-PAGE was performed to control the result of the purification steps (Fig. 2). The analysis of the flow through and comparison with the injected sample show that some IgG1 did not bind to the protein A column (lane 1 and 2). The protein bands of IgG1 heavy chains (HC) and IgG1 light chains (LC) are visible at 55 kDa and 22 kDa in the SDS-PAGE. Further, a larger un-specific band at 70 kDa was detected. This band was only detected in the flow through and not in the purified IgG (lane 2, 3, 4) showing that IgG1 was not contaminated with other proteins. The IgG1 after the protein A column (lane 3) and after the desalting column (lane 4) have a similar concentration showing no protein loss in the second purification step.

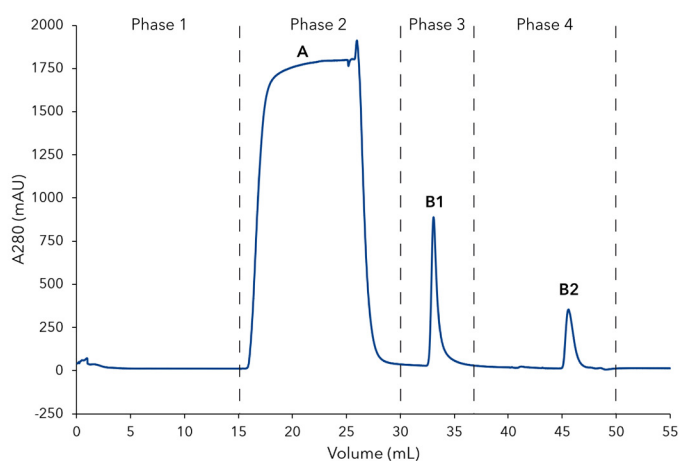

Fig. 1 Chromatogram of the two-step mouse IgG purification; Phase 1 Affinity chromatography (AC): 1 Column equilibration with buffer A; 2 Feed injection and column washing; 3 Elution of IgG from protein A column with buffer B and parking in 1mL sample loop; Phase 2 - Buffer exchange with desalting column: 4. Elution of IgG with buffer C; A-flow through; B1-elution peak of IgG from protein A column; B2-elution peak of IgG after desalting column

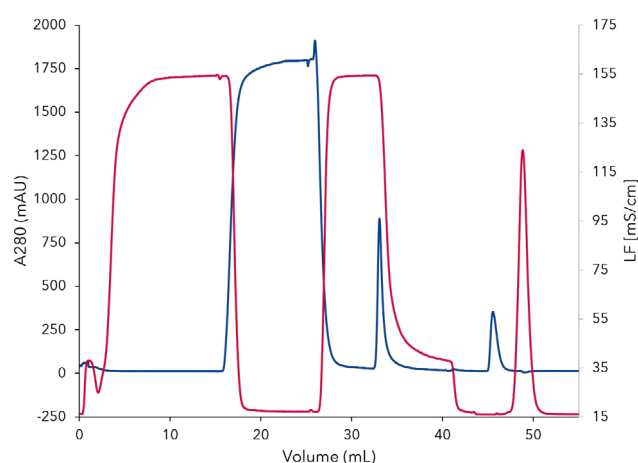

Fig. 2 Chromatogram of the two step mouse IgG purification with UV and conductivity signal; UV signal at 280 nm in blue; conductivity signal in red; after desalting (45min) elution peak (blue) and salt peak (red) are clearly separated

MATERIALS AND METHODS

The AZURA two step purification system was used for this application. It consists of AZURA P 6.1L HPG; 1st ASM 2.1L with feed pump and two 6 port/3 channel injection valves; second ASM 2.1L with UVD 2.1S and two 6 port/3 channel injection valve; a column switching valve; a conductivity monitor and a fraction collector. The protein A column (ZetaCell protein A, 1 mL) was equilibrated with 15 mL buffer A (TBS) at 1 mL/min. Then 10 mL of feed at 1mL/min were injected and column washed with 5 mL buffer A at 1 mL/min. The antibody was then eluted with 10 mL elution buffer B (0.2 M Na Citrate, pH 3) and the eluting antibody collected in sample loop. Finally, the protein was re-injected and eluted with 15 mL of buffer C (PBS pH 7.4) over the desalting/gel filtration column at 1 mL/min. The UV signal (280 nm) and the conductivity signal were recorded.

CONCLUSION

Mouse IgG was successfully purified from cell culture medium by an automated combination of an affinity chromatography and gel filtration method on the two-step dedicated AZURA Bio purification system. No manual interaction was necessary. The method setup could easily be adapted to other purification protocols for the separation of biomolecules. This application is an example of a time-saving automation of protein purification and can be easily adapted to various protein purification protocols.

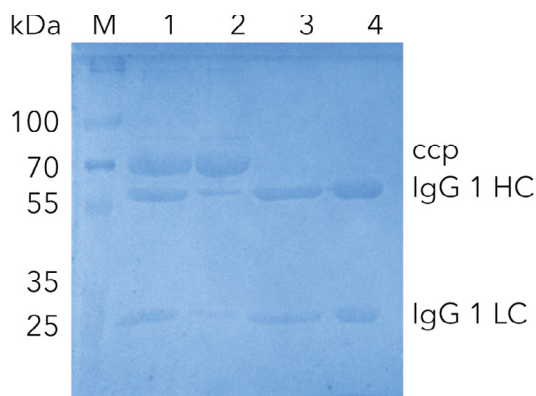
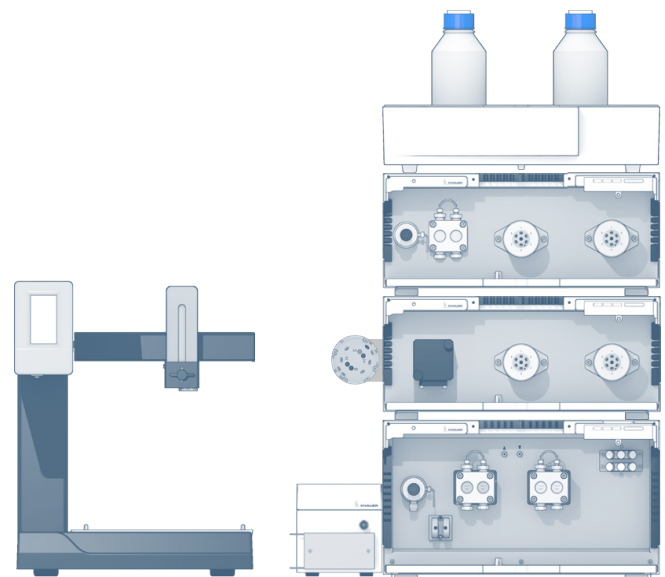

Fig. 3 SDS-PAGE of IgG1 at different purification steps; M) Marker in kDa; 1) cell culture supernatant; 2) flow through; 3) pure IgG1 after elution from protein A column; 4) pure IgG1 after desalting column; ccp cell culture proteins; IgG1 HC (heavy chain); IgG1 LC (light chain)



ADDITIONAL MATERIALS AND METHODS

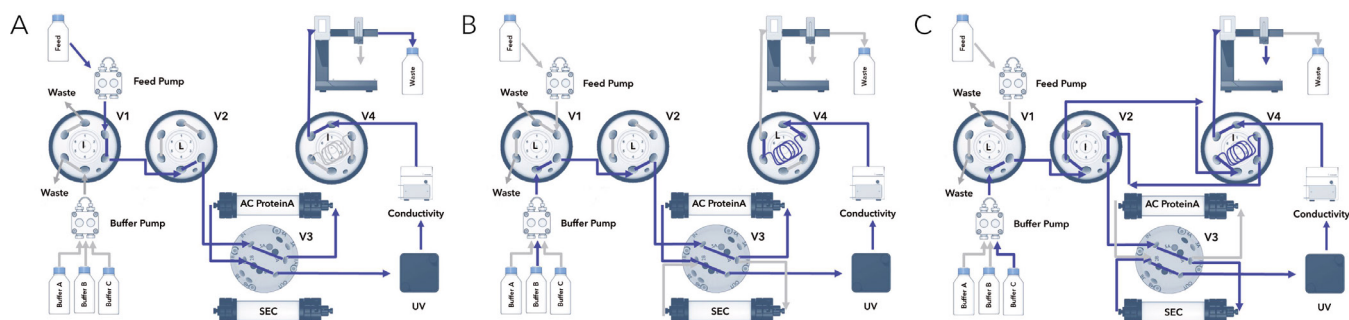

Fig. A1 Flow chart of the two - step purification illustrating major method steps; A Feed injection and antibody binding on protein A column, flow through to waste, washing afterwards with buffer A (not shown); B Protein elution from protein A column with buffer B and protein parking in sample loop; C Re-injection of parked protein on SEC desalting column, buffer and pH exchange using buffer C, fractionation of target peak; valve positions = I) injection, L) load.

The system configuration and the different valve settings are shown in Fig. A1. The first injection valve (V1) is used for the injection of the sample. To this valve the feed pump and the buffer pump are connected. The other two injection valves are necessary for the inversion of the flow direction (V2 + V4). They also switch the flow to the waste/fraction collector and in/out of the sample loop. The sample loop allows the collection and (re)injection of the peak of interest. The two columns are connected to the column switching valve (V3). In the initial configuration (Fig. A1 A) the sample is injected onto the column by the feed pump. The non-binding protein is directed to the waste. After washing the column, IgG is eluted with eluent B (Fig. A1 B). The valves are switched to the peak parking position (V2 + V4 in Load position). The eluting protein is collected in the sample loop. Subsequently, the collected protein is automatically re-injected onto the second column by changing the valve position for V2 and V4 from Load to Inject and for V3 from position 1 (column 1) to position 2 (column 2) (Fig. A1 C). The flow is inverted and the sample loop is emptied. The eluted protein peak is fractionated by a fraction collector. No manual interaction is necessary during the purification.

Tab. A1 Method parameters

Eluent A	Washing buffer: TBS (Tris-buffered saline)		
Eluent B	Elution buffer: 0.2 M NaCitate, pH 3		
Eluent C	Storage buffer: PBS (phosphate buffered saline) pH 7.4		
Flow rate	1 mL/min	System pressure	1.5 bar
Column temperature	RT	Run time	55 mL
Injection volume	10 mL	Injection mode	Feed pump
Detection wavelength	280 nm	Data rate	500 ms

Tab. A2 Purification steps run at a flowrate of 1 mL/min; AC - affinity chromatography, GF - gel filtration

Time (mL)	% A	% B	% C	Feed pump	Method	Description
0-15	100			-		Equilibration
15-25				100	AC	Injection
25-30	100				AC	Washing
30-40		100			AC	Elution and peak parking
40-55			100		GF	Re-injection buffer

Tab. A3 System configuration

Instrument	Description	Article No.
Pump	AZURA P 6.1 L, HPG, ceramic, 50 mL	APH68FB
Flow cell	3 mm, 2 µL	A4045
Assistant 1	AZURA ASM 2.1L Left: P 4.1S, 50 bar, 50 ml, ceramic Middle: 6Port2Pos, 1/16", PEEK, 200 bar Right: 6Port2Pos, 1/16", PEEK, 200 bar	AYBLECEC
Assistant 2	AZURA ASM 2.1L Left: UVD 2.1S Middle: 6Port2Pos, 1/16", PEEK, 200 bar Right: 6Port2Pos, 1/16", PEEK, 200 bar	AYCAECEC
Valve	Column selection valve	AWB00FC
Fraction collector	Foxy R1	A59100
Conductivity monitor	CM2.1S	ADG30
Column 1	Protein A 1ml column for crude samples	upon request
Column 2	Sepapure Desalting 5 mL	020X460SPZ
Software	PurityChrom, standard licence	A2650



AZURA® Two Step Purification System

Comparison of IgG purification with two different protein A media

Michaela Schulze, Kate Monks; applications@knauer.net
KNAUER Wissenschaftliche Geräte GmbH, Hegauer Weg 38, 14163 Berlin; www.knauer.net

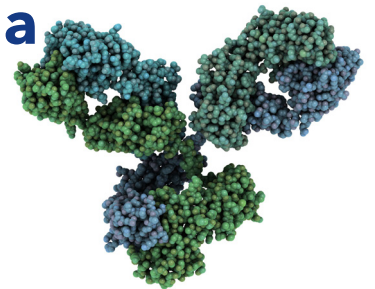

SUMMARY

The purification of antibodies is generally performed with protein A column materials. Two prepacked protein A columns from two different suppliers were compared in their ability to purify immunoglobulin antibodies (IgG) from human plasma. Capacity and yield were compared and revealed no significant differences in the performances of the two investigated columns.

INTRODUCTION

Today, the most widely used affinity chromatography purification procedure in industry is the capture of antibodies using protein A ligand. Affinity chromatography is used to isolate and enrich proteins or nucleic acids from complicated mixtures like human plasma. The principle is based on biospecific interactions between two reaction partners. The column matrix contains a covalently bound ligand to which the substance of interest specifically binds. A certain

buffer is needed to elute the antibodies bound to the matrix. This type of chromatography is very efficient and delivers a highly clean protein. An AZURA® Bio purification system was used for comparison of two affinity materials. Here, an automated method to purify IgG from human plasma was used. Two protein A media were compared. The capacity of the columns to bind IgG was determined for both materials.



Comparison of IgG purification with two different protein A media

RESULTS

The IgG were purified from 500 μ L human plasma by affinity chromatography using protein A columns. The eluted antibodies were then automatically collected with a fraction collector. The chromatogram of the whole purification process is divided in three steps (**Fig 1 A&B**). During the first step, the protein A column was equilibrated with buffer A followed by feed injection. The proteins that did not bind to the protein A columns went to waste and were visible as large flow through peak in step one. Thereafter, the column was washed with buffer A until no further peaks were detected. During step two, the antibodies

were eluted from the column with buffer B and collected in 1 mL fractions. In the last step, the protein A columns were equilibrated with the buffer A in preparation for the next sample injection. Three runs were performed for each column material. The amount of purified protein was with 6 mg IgG originating from 500 μ L human plasma are similar (**Tab 1**). Moreover, a SDS PAGE analysis was performed with the IgG samples to check the purity of the individual fractions. The protein bands of IgG heavy chains (HC) and IgG light chains (LC) are visible at 48 kDa and 25 kDa in the SDS-PAGE (**Fig A1**, suppl. material).

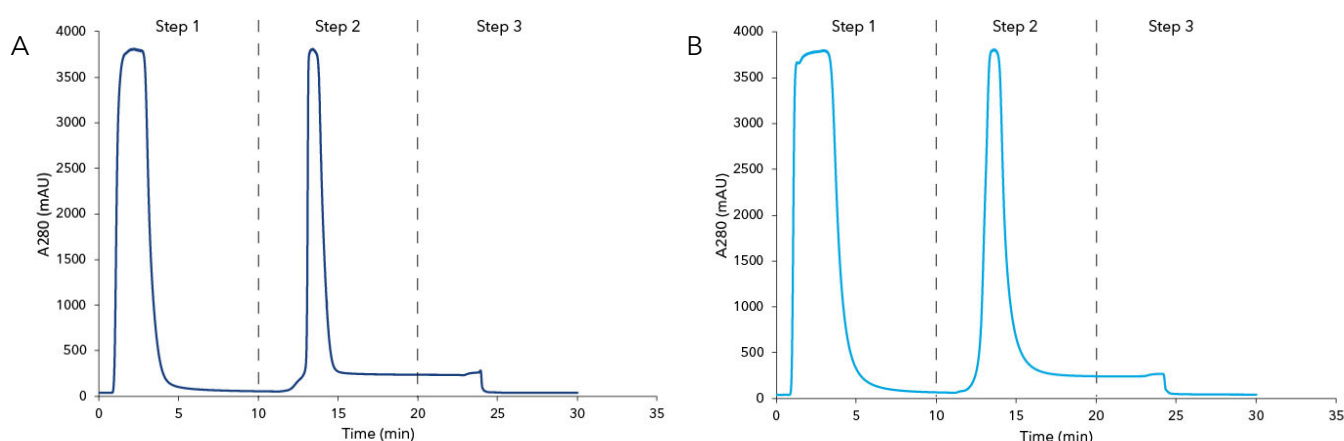

Fig. 1 Chromatogram of antibody purification with Protein A HP column from vendor x (A) and Sepapure Protein A FF (B) columns; Step 1: injection peak of human plasma and column washing; Step 2: elution peak of IgG from protein A column with buffer B; Step 3: column equilibration with buffer A

Tab. 1 Total and fraction concentrations of IgG purified with Sepapure Protein A FF or Protein A HP column from vendor x for three runs

Run	Column	IgG concentration in fraction (mg/mL)	Fraction size (mL)	Total IgG amount in fractions (mg)
1	Sepapure Protein A FF	0.82	7	5.74
2	Sepapure Protein A FF	0.83	7	5.81
3	Sepapure Protein A FF	0.87	7	6.09
4	Protein A HP vendor x	0.95	6	5.70
5	Protein A HP vendor x	1.00	6	6.00
6	Protein A HP vendor x	1.04	6	6.24

MATERIALS AND METHODS

In this application an AZURA Bio purification system was used. It consisted of an AZURA P 6.1L LPG metal-free pump, AZURA ASM 2.1L assistant module with feed pump and two 6 port/3 channel injection valves, an AZURA DAD 2.1L diode array detector with 10 mm, 10 μ L flow cell cartridge; AZURA CM 2.1 conductivity monitor and a fraction collector.

The two 5 mL protein A columns were equilibrated with 20 mL buffer A (20 mM phosphate Buffer pH 7.0) at 2 mL/min. Then 500 μ L human plasma were injected and the column washed with 20 mL buffer A at 2 mL/min.

The antibodies were then eluted with 20 mL elution buffer B (0.1 M Glycin-HCL, pH 2.7) and collected with the fraction collector. The concentrations of the IgG fractions from each individual run were determined with a NANODROP 2000 [Tab 1](#)). The UV signal was measured at 280 nm and conductivity signal was recorded.

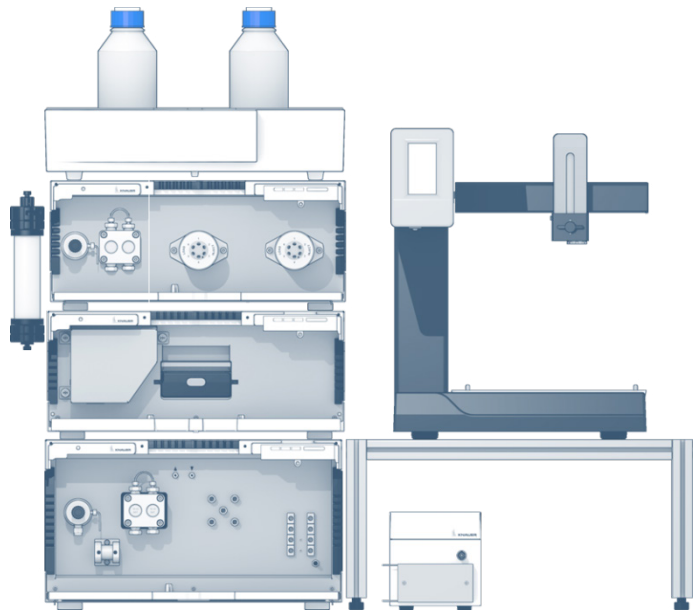

CONCLUSION

Human immunoglobulin antibodies (IgG) were successfully purified with both protein A materials via affinity chromatography with the AZURA Bio purification system. An average of 6 mg IgG was purified from 500 μ L of human plasma with both columns. When compared via SDS PAGE, in both cases eluted proteins are identical in purity. All in all, it can be concluded that the purification is quantitatively and qualitatively identical for both tested column materials.

REFERENCES

[1] Janeway CA Jr, Travers P, Walport M, et al.; Immunology: The Immune System in Health and Disease. 5th Edition, New York; Garland Science, 2001

ADDITIONAL MATERIALS AND METHODS

Tab. A1 Method parameters

Buffer A	20 mM phosphate buffer pH 7.0		
Buffer B	100 mM Glycin - HCl pH 2.7		
Gradient	Time [min]	% A	% B
	0-10	100	0
	10-20	0	100
	20-30	100	0
Flow rate	2 mL/min	System pressure	0 bar
Column temperature	25°C	Run time	30 min
Injection volume	0.5 mL	Injection mode	Full loop
Detection wavelength	280 nm	Data rate	10 Hz

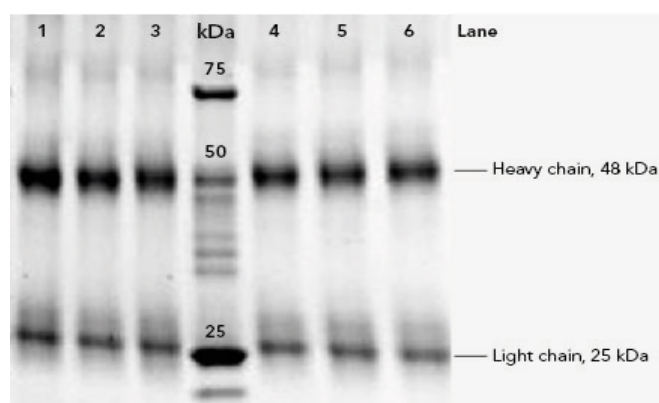

Fig. A1 SDS Page of the eluted IgG from human plasma; Lanes 1 - 3 IgG (4 µg) purified from three runs with the Sepapure Protein A FF column; Marker (10 µL) in kDa; Lanes 4-6 IgG (4 µg) purified from three runs with the vendor x column

Tab. A2 System configuration

Instrument	Description	Article No.
Pump	AZURA P 6.1L LPG, metal-free	APH64EB
Detector	AZURA DAD 2.1L	ADC01
Flow cell	10mm, 10µL, Ti, 300bar	AMC38
Assistant	AZURA ASM 2.1L Left: Pump with pressure sensor, 50 mL pump head, SSt Middle: 6 port 2 position injection valve, 1/16" connectors Right: 6 port 2 position injection valve, 1/16" connectors	AYBHECEC
Fraction collector	Foxy R1	A59100
Conductivity monitor	CM 2.1S	ADG30
Column 1	Protein A HP 5 mL from vendor x	-
Column 2	Sepapure Protein A FF, 5 mL Column	020X39FSPZ
Software	PurityChrom 3D Option	A2654

RELATED KNAUER APPLICATIONS

[VBS0063](#) - Automated two - step purification of mouse antibody IgG1 with AZURA Bio purification system

[VBS0067](#) - Automated two-step purification of 6xHis-tagged GFP with AZURA Bio purification system

[VBS0068](#) - Fast and robust purification of antibodies from human serum with a new monolithic protein A column

[VBS0066](#) - Fast and sensitive size exclusion chromatography of IgG antibody

[VBS0069](#) - Purification of Sulfhydryl Oxidase

Fast and sensitive size exclusion chromatography of IgG antibody

Lilit Avagyan, Michaela Schulze, Hagen Schlicke, Kate Monks; applications@knauer.net
KNAUER Wissenschaftliche Geräte GmbH, Hegauer Weg 38, 14163 Berlin; www.knauer.net

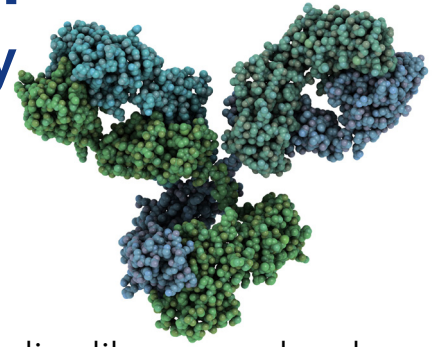

SUMMARY

Size exclusion chromatography (SEC) for analysis of antibodies like monoclonal immunoglobulin G (IgG) is a commonly used separation technique. AZURA® UHPLC system and TOSOH TSKgel UP-SW3000 silica based columns allow a faster and more sensitive determination of IgG compared to e.g. USP 129 application.

INTRODUCTION

The application field of monoclonal antibodies (mAb) goes from diagnostic kits up to active pharmaceutical ingredients for the treatment of autoimmune diseases and cancer. Since the commercialization of the first therapeutic antibody product in 1986, this class of biopharmaceutical products has grown significantly. Until 2020 about 70 new mAb products are predicted to be developed [1]. In the field of bio-chromatography, the research on separation of mAb increase

accordantly. The SEC is the first-choice application for this purpose. However, the duration of the method is usually very long and the consumption of chemicals is high. Here, the increase of sensitivity and reduction of analysis time was reached by using silica based TOSOH TSKgel UP-SW3000 columns with 2 µm particle size and different column length. The analysis was performed on AZURA UHPLC system with AZURA DAD 6.1L diode array detector.

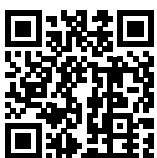

Fast and sensitive size exclusion chromatography of IgG antibody

RESULTS

Fig. 1 shows an overlay of two chromatograms, obtained by applying of IgG standard (diluted up to 1 mg/mL) on TSKgel UP-SW3000 columns with 300 mm (red) and 150 mm (blue) length. The retention time of the main peak representing IgG was recorded 6.61 and 3.59 min respectively (**Tab. 1**). The highest response value of 24.8 mAU/ μ g was reached with

150 mm length column. This is an increase by the factor of 1.55 and 7.51 compared to the 300 mm length column and to the certificated data respectively. The run time could be reduced from 30 (USP application) to 7 min (150 mm column). Compared to certificate data sheet and USP method (**Tab. 1**), the consumption of the sample was reduced up to four times.

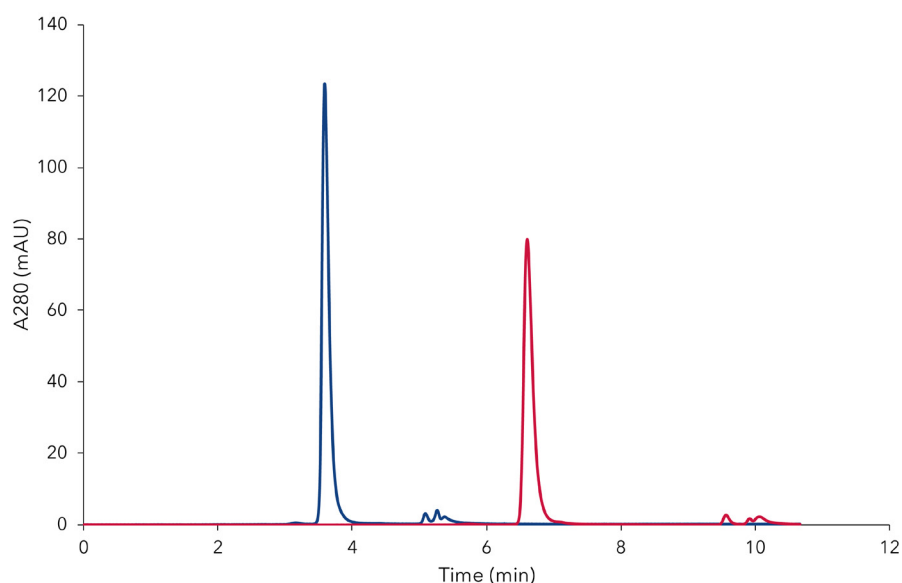

Fig. 1 Chromatograms overlay of IgG, obtained from measurement of diluted sample 1 mg/mL measured with 300 mm (red) and 150 mm (blue) columns, injection volume 5 μ L

Tab. 1 Result table of IgG standard, measured via AZURA UHPLC system and TOSOH columns, compared to certificate data of standard.

Parameters			Certificate data
Column material	Silica based	Silica based	Packing L59
Particle size (μ m)	2	2	5
Column size (mm)	4.6 x 300	4.6 x 150	7.8 x 300
Flow rate (mL/min)	0.4	0.4	0.5
Sample concentration (mg/mL)	1	1	10
Injection volume (μ L)	5	5	20
Peak height (mAU)	80	124	650
Response (mAU/ μ g)	16.0	24.8	3.3
Retention time (min)	6.61	3.59	15.48
Run time (min)	12	7	30

MATERIALS AND METHOD

The AZURA UHPLC system consists of AZURA P 6.1L HPG pump, AZURA DAD 6.1L detector, LightGuide flow cell (10 mm, 2 μ L), AZURA AS 6.1L autosampler, AZURA CT 2.1 thermostat and ClarityChrom software. As mobile phase a phosphate buffer with 0.14 M monobasic potassium phosphate, 0.06 M dibasic potassium phosphate and 0.25 M potassium chloride (pH 6.2) was used. The standard "monoclonal IgG system suitability" (USP catalog No. 1445550) was obtained by Sigma Aldrich. The stock solution (10 mg/mL) was diluted with mobile phase and used for analyses. The separation was applied on two TSK-gel UP-SW3000 columns with 2 μ m particle size and 4.6 x 300 mm and 4.6 x 150 mm column dimensions. The measurements were performed in isocratic mode with 0.4 mL/min flow rate. The injection volume was 5 μ L. Determination took place at 280 nm, sampling rate of 20 Hz and time constant 0.05 sec. The column thermostat was adjusted to 25 $^{\circ}$ C. For characterization of sensitivity the response (R) of the signals was calculated according to the following equation, where H is the height of the peak (in mAU) and m is the mass of the sample (in μ g):

$$R [mAU/\mu g] = \frac{H [mAU]}{m [\mu g]}$$

CONCLUSION

As the results show the application for determination of IgG could be significantly improved concerning run time and sensitivity by the using of AZURA UHPLC system and TOSOH TSKgel UP-SW3000 silica based columns.

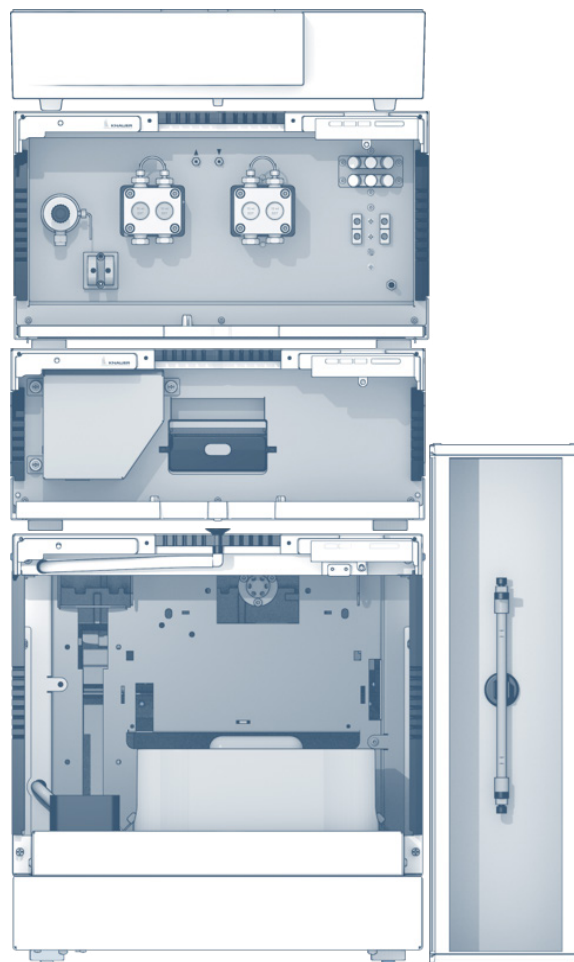

REFERENCES

- [2] Dawn M Ecker, Susan Dana Jones and Howard L Levine, Jones SD, Levine HL, The therapeutic monoclonal antibody market, MAbs. 2015 Jan-Feb; 7(1): 9-14.

ADDITIONAL RESULTS

Fig. A2 depicts a chromatogram of stock solution of IgG standard. 5 μ L of the standard was injected on 300 mm TSKgel UP-SW3000 column. The obtained peak maximum value is 615.3 mAU (**Fig. A2**). Compared to certificate data sheet (**Fig. A1**) and USP method (**Tab. 1**), the consumption of the sample was reduced up to 4 times.

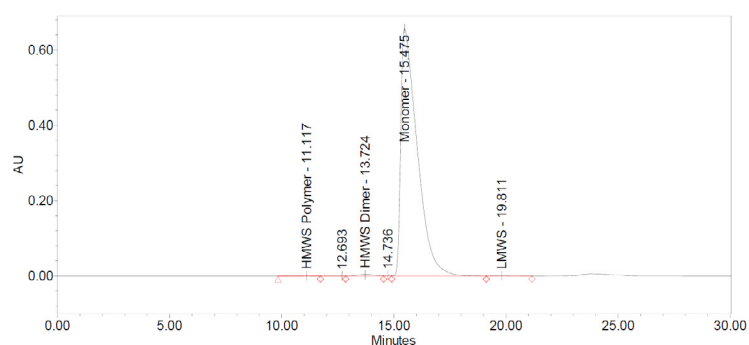

Fig.A1 Chromatogram of IgG, obtained from USP-standard certificate. Sample concentration 10 mg/mL, injection volume 20 μ L

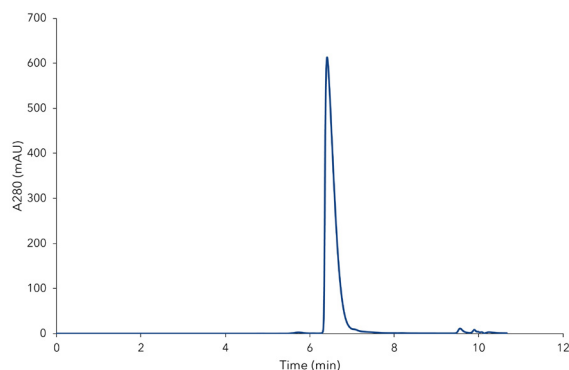

Fig.A2 Chromatogram of IgG, obtained from measurement of stock solution. Sample concentration 10 mg/mL, injection volume 5 μ L

ADDITIONAL MATERIALS AND METHODS

Tab.A1 Method parameters

Eluent A	Phosphate buffer, pH 6.2		
Gradient	isocratic, 100 % A		
Flow rate	0.4 mL/min	System pressure	320 bar, 124 bar
Column temperature	25°C	Run time	12 min
Injection volume	5 μ L	Injection mode	Partial loop fill
Detection wavelength	280 nm	Data rate	20 Hz
		Time constant	0.05 sec

Tab.A2 System configuration

Instrument	Description	Article No.
Pump	AZURA P 6.1L HPG, 5 mL, SS	APH35GA
Autosampler	AZURA AS 6.1 L	AA01AA
Detector	AZURA DAD 6.1L	ADC11
Flow cell	LightGuide 10 mm, 2 μ L	AMC19XA
Thermostat	AZURA CT 2.1	A05852
Columns	TSKgel UP-SW3000, 4.6 mm ID x 30 cm, 2 μ m TSKgel UP-SW3000, 4.6 mm ID x 15 cm, 2 μ m	
Software	ClarityChrom	A1672-9

RELATED KNAUER APPLICATIONS

[VBS0063](#) - Automated two - step purification of mouse antibody IgG1 with AZURA Bio LC Lab system

[VBS0064](#) - Comparison of IgG purification by two different protein A media

[VBS0067](#) - Automated two-step purification of 6xHis-tagged GFP with AZURA Bio LC

[VBS0068](#) - Fast and robust purification of antibodies from human serum with a new monolithic protein A column

[VBS0069](#) - Purification of Sulphydryl Oxidase

Automated two step purification of 6xHis-tagged GFP

Ulrike Maschke, Yannick Krauke, Kate Monks; applications@knauer.net
KNAUER Wissenschaftliche Geräte GmbH, Hegauer Weg 38, 14163 Berlin;
www.knauer.net

SUMMARY

Affinity chromatography by His-tag is one of the most widespread purification techniques for recombinant proteins. In most cases it requires an additional cleaning/polishing step. This application highlights the possibility of combining two subsequent chromatography protocols without manual interaction using the AZURA® Bio purification system.

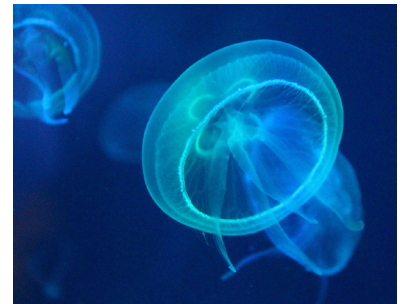

INTRODUCTION

Affinity chromatography (AC) is one of the most efficient techniques to purify recombinant proteins. Mostly, AC is performed on crude samples like bacterial lysates containing the recombinant protein that is genetically engineered to be expressed with a tag that enables the specific capture of the recombinant protein. These highly efficient tags are used for affinity binding to specific affinity chromatography materials. A variety of tags is available among which the polyhistidine tag is the most widespread one. In this application, six histidine (6xHis) residues were attached to the green fluorescent protein (GFP). The histidine

residues bind with very high affinity to the immobilized metal ions on the column (immobilized metal ion affinity chromatography (IMAC)). In many protocols, an additional step is recommended to reach higher purity or to change the buffer of the purified protein to a suitable storage buffer. Here, size exclusion chromatography was used as second step to exchange the buffer of the purified protein. Purification of recombinant proteins can be performed manually or by using a chromatography system combining two steps automatically to save time and effort.

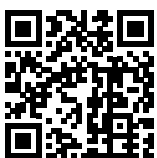

Automated two-step purification of 6xHis-tagged GFP

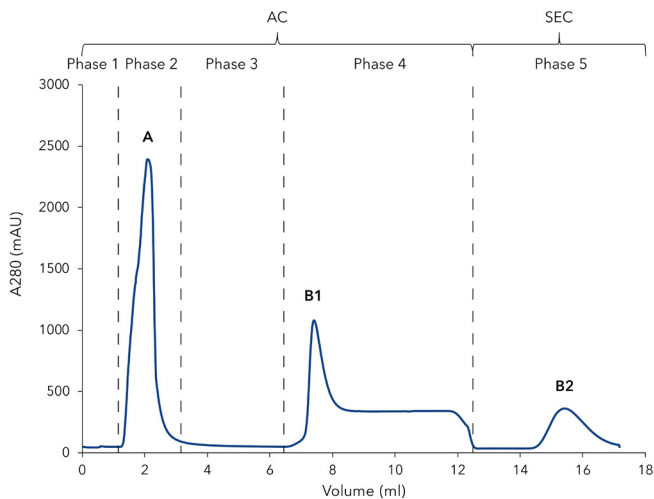

Fig. 1 Chromatogram of the two-step 6xHis-GFP purification; 280 nm UV signal, Step1) Affinity chromatography (AC)/ Ni- NTA column: 1) Column equilibration; 2) Sample injection; 3) Column washing; 4) Elution of 6xHis-GFP and parking in 1 mL sample loop; Step2) Buffer exchange with desalting co-lumn: 5 Elution of 6xHis-GFP ; A) flow through of unbound protein; B1) elution peak of 6xHis-GFP from Ni-NTA column; B2) elution peak of 6xHis-GFP

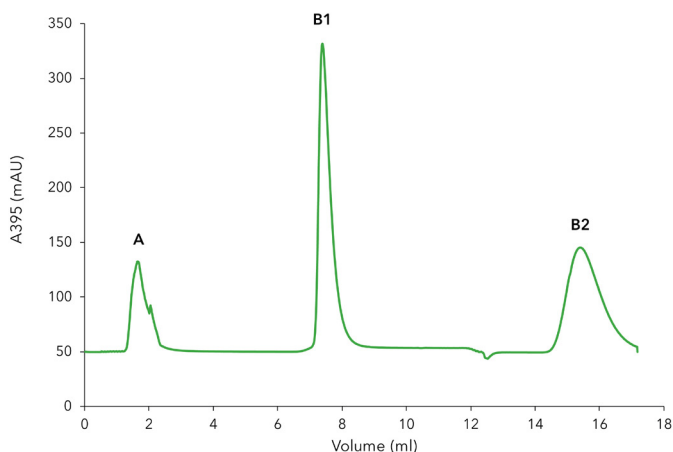

Fig. 2 Chromatogram of the two-step 6xHis-GFP, GFP detection with 395 nm UV signal, A) flow through of unbound pro-tein; B1) elution peak of 6 x His-GFP from Ni - NTA column; B2) elution peak of 6 x His-GFP

RESULTS

The chromatogram of the 6xHis-GFP purification shows the five phases of the two-step protocol (**Fig. 1**). After equilibration (**Fig. 1**, phase 1) the lysate was injected and the GFP bound to the Ni-NTA affinity column via the 6xHis-tag. All other non-binding proteins and impurities are in the large flow through peak (**Fig. 1**, phase 2, peak A). Subsequently, the column was washed until the baseline was stable (**Fig. 1**, phase 3). The eluted protein (**Fig. 1**, phase 4, peak B1) was collected in a sample loop and re-injected on the desalting column (**Fig. 1**, phase 5) to exchange the buffer from high imidazole concentrations to a buffer without imidazole. The purified protein (**Fig. 1**, peak B2) was collected by the fraction collector.

Additionally to the unspecific photometrical detection of all proteins at 280 nm, GFP-signal was recorded at 395 nm (**Fig. 2**) with the multi-wavelength detector. Most of the 6xHis-tagged GFP bound to the column as only a small peak for GFP is visible in the flow through. The purification results were confirmed by SDS-Page (**Fig. 3**). The cell lysate (**Fig. 3**, lane 1) shows a prominent band representing the overexpressed 6xHis GFP. This band is cleared in the flow through (**Fig. 3**, lane 2), confirming that most of the tagged protein bound to the column. The eluted sample (**Fig. 3**, lane 3) shows the purified 27 kDa 6xHis-GFP with only minor contaminations.

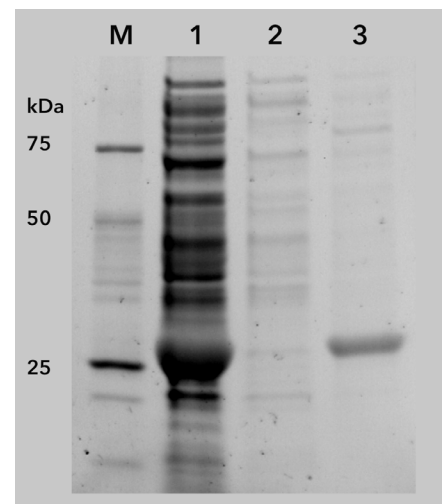

Fig. 3 SDS-PAGE of two-step 6xHis-GFP purification M - marker, 1) lysate before purification, 2) flow through, 3) eluted 6xHis-GFP (27 kDa) after two-step purification

MATERIALS AND METHODS

The AZURA two-step purification system with a multi-wavelength detector was used for this application. It consists of AZURA P 6.1L HPG, one autosampler AZURA ASM 2.1L with feed pump and two 6 port/3 channel injection valves; a second ASM 2.1L with two 6 port/3 channel injection valves; the MWD 2.1L multi-wavelength detector, a column switching valve, a conductivity monitor, and a fraction collector. The Sepapure FF Ni-NTA 1 mL column was equilibrated prior to the run with 15 mL load/wash buffer (PBS pH 7.5, 10 mM imidazole) at 1 mL/min. 100 μ L lysate containing the 6 x His tagged GFP was loaded on to the column at a flowrate of 0.3 mL/min. The column was washed with 4 mL load/wash buffer at a flowrate of 1 mL/min. The load/wash buffer had a low amount of imidazole to reduce non-specific binding of impurities. 6 x His tagged GFP was eluted with 5 mL elution buffer (PBS, pH 7.5, 500 mM imidazole) and collected in a 1 mL sample loop. The eluted protein was re-injected on to a 5 mL desalting column to exchange the buffer from high imidazole concentrations from the elution buffer to the final desalting buffer without imidazole. 7 mL desalting buffer (PBS pH 7.4) was used for the gel filtration run at a flowrate of 1 mL/min. The protein was collected in a fraction collector. The UV signal at 280 nm and 395 nm, as well as the conductivity signal were recorded.

CONCLUSION

6xHis-tagged GFP was purified by an automated two-step protocol combining an affinity chromatography method to capture 6xHis-tagged GFP with a subsequent buffer exchange step by size exclusion chromatography. This automatization requires no time consuming manual interaction. The method set up is an excellent example for a two-step protein purification and can be adapted to a variety of protein purification protocols. The benefit of a multi wavelength detector was shown measuring at two different wavelengths.

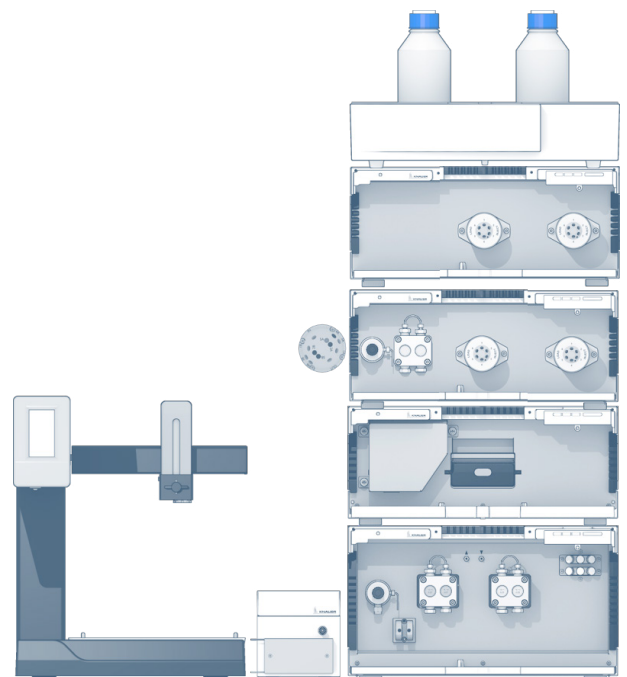

ADDITIONAL MATERIALS AND METHODS

Tab. A1 Method parameters

Eluent A	Loading/washing buffer: PBS (phosphate-buffered saline) pH 7.5, 10 mM imidazole		
Eluent B	Elution buffer: PBS pH 7.5, 500 mM imidazole		
Eluent C	Desalting buffer: PBS pH 7.4		
Gradient	Volume [mL]	% A	% B
	0-0.5	100	0
	0.5-2	100	0
	2-6	70	30
	6-11	0	100
	11-18	0	100
Flow rate	1 mL/min	System pressure 1.0 bar	
Column temperature	RT	Run time	18 min
Injection volume	100 µL	Injection mode	Full loop
Detection wavelength	280 nm 395 nm	Data rate	-
		Time constant	500 ms

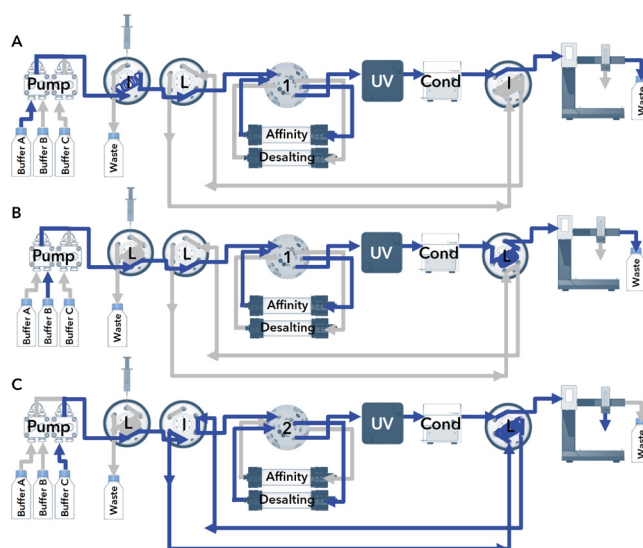

Fig. A1 Flowchart; A) sample injection, B) elution and peak parking, C) reinjection

Tab. A2 System configuration

Instrument	Description	Article No.
Pump	AZURA P 6.1L HPG, ceramic, 50 mL	APH68FB
Detector	MWD 2.1L	ADB01
Flow cell	10 mm, 1/16", 10 µL, 300 bar, biocompatible	AMC38
Assistant 1	AZURA ASM 2.1L Left: feed pump 50 ml Ti Middle: Injection valve 6/3 channel PEEK Right: injection valve 6/3 channel PEEK	AYBHECEC
Assistant 2	Left position: - Injection valve 6/3 channel PEEK Right position: injection valve 6/3 channel PEEK	
Conductivity monitor	AZURA CM 2.1S	ADG30
Flow cell	Preparative, flow rates up to 100 mL	A4157
Valve	Column selection valve	AWB00FC
Column	Sepapure FF Ni-NTA 1 mL Sepapure Desalting 5 mL	010X39FPSZ 020X460SPZ
Fraction collector	Foxy R1	A59100
Software	PurityChrom® 5 Upgrade	

RELATED KNAUER APPLICATIONS

[VBS0063](#) - Automated two - step purification of mouse antibody IgG1 with AZURA Bio purification system

[VBS0064](#) - Comparison of IgG purification by two different protein A media

[VBS0068](#) - Fast and robust purification of antibodies from human serum with a new monolithic protein A column

[VBS0066](#) - Fast and sensitive size exclusion chromatography of IgG antibody

[VBS0069](#) - Purification of Sulphydryl Oxidase

Purification of Sulphydryl Oxidase

Ulrike Krop, David Thiesing¹, Tigran Kharatyan¹, Jessica Thiesing-Paul, Kate Monks; applications@knauer.net
KNAUER Wissenschaftliche Geräte GmbH, Hegauer Weg 38, 14163 Berlin; www.knauer.net
¹ SternEnzym GmbH & Co. KG, Ahrensburg, Germany

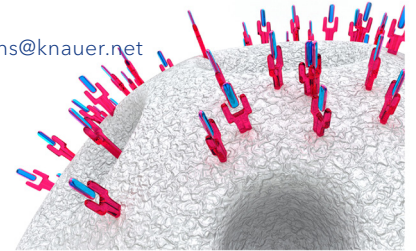

SUMMARY

Enzymes play a key role in food production. The use of recombinant enzymes for the food industry is a growing market. In this application we describe the purification of sulfhydryl oxidase (SOx) by affinity chromatography. Its stabilizing potential makes this enzyme an ideal candidate for food applications where proteins play a role, for example baking products or egg dishes. Additionally SOx is commercially rare and the broad application field provides huge potential for the food industry.

INTRODUCTION

With the recombinant expression of functional proteins through the development of modern biotechnology, enzymes have a special status in industry and research. Sulfhydryl oxidase (SOx) catalysis the formation of disulfide bonds within and between proteins which naturally plays a fundamental role for the

folding of proteins during cell metabolism. In industrial food production, intermolecular crosslinks of proteins can have a stabilizing effect on products and could be used as a biological substitute for chemical stabilizers. [1] The future production and the commercial distribution is therefore of high interest.

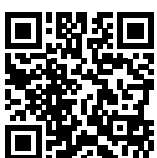

Purification of Sulphydryl Oxidase

RESULTS

The recombinantly produced His-tagged SOx was purified with an immobilized metal ion chromatography (IMAC) resin. The chromatogram is shown in **Fig. 1**. Peak A represents the flow-through of unbound proteins. The His-tagged SOx was eluted with buffer B (Peak B) and collected via the fraction valve. The collected sample was analyzed by SDS-PAGE to check for impurities and evaluate the purity of the collected

sample (**Fig. 2**). The recombinant His-tagged SOx has a molecular weight of 15 kDa. The supernatant shows a prominent 15 kDa band representing the expressed SOx. This band is not visible in the flow through fraction. Most of the His-tagged SOx bound to the IMAC column. Only minor contaminations are visible in the eluted protein fraction. A standard of SOx at a concentration of 1.13 g/L was prepared.

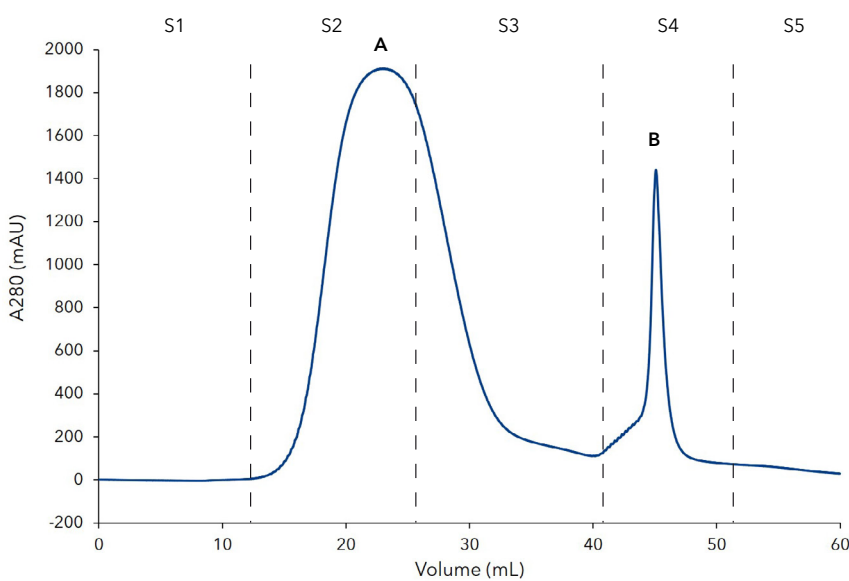

Fig. 1 Chromatogram of SOx affinity purification; A) flow through of unbound protein, B) elution peak of SOx; S1) column equilibration, S2) sample application, S3) column washing, S4 - elution of His-tagged Sox, S5 - re-equilibration

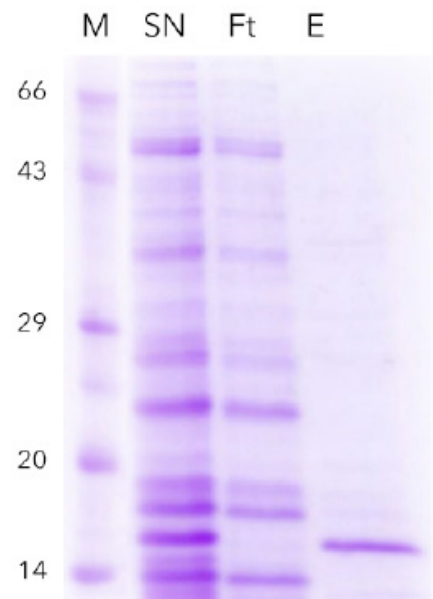

Fig. 2 SDS-PAGE of SOx purification, M) marker, SN) supernatant with overexpressed protein Ft) flow through, E) eluted protein (purified SOx protein ~ 15 kDa)

MATERIALS AND METHODS

An AZURA® Bio purification system consisting of an AZURA P 6.1L HPG metal-free pump, AZURA ASM 2.1L assistant module 6 port/3 channel injection valve and a 6 port multi position fraction valve, an AZURA MWD 2.1L multi wavelength detector with semi-preparative biocompatible 3 mm, 2 µL flow cell cartridge was used. A Tricorn™ 10/200 column was filled with Chelating Sepharose™ Fast Flow to a column volume of 15 mL. The column was equilibrated with 50 mM NaOAc, pH 5.0 and loaded with nickel ions by applying 0.5 column volume 50 mM NaOAc, 100 mM NiSO₄, pH 5.0. Unbound ions were washed out with 50 mM NaOAc, pH 5.0. Sulfhydryl-Oxidase was over expressed in *Bacillus subtilis*. After cultivation the fermentation broth was centrifuged for 30 min at 4300 x g for primary clarification purposes. The supernatant was 0.45 µm filtered, concentrated via ultrafiltration and subsequently used for the chromatographic purification. After applying the supernatant, the IMAC column was washed for 6 min at a flow rate of 3 mL/min with buffer A. Next, the target protein was eluted with 15 mL Buffer B and collected with the fraction valve. The column was re-equilibrated with buffer A. The UV signal was measured at 280 nm. The samples were analyzed for purity by SDS-PAGE.

REFERENCES

[1] Trivedi, M. V., Laurence, J. S., & Siahaan, T. J. (2009). The role of thiols and disulfides on protein stability. *Current protein & peptide science*, 10(6), 614-625.

CONCLUSION

Purification and concentration of SOx with the AZURA Bio purification system was successfully established. The recombinant His-tagged SOx was over-expressed in *Bacillus subtilis* and could be purified by IMAC from the fermentation supernatant. The availability of pure enzyme enables tests for further characterization of the target enzyme as well as precise identification of the SOx' potential in diverse food applications.

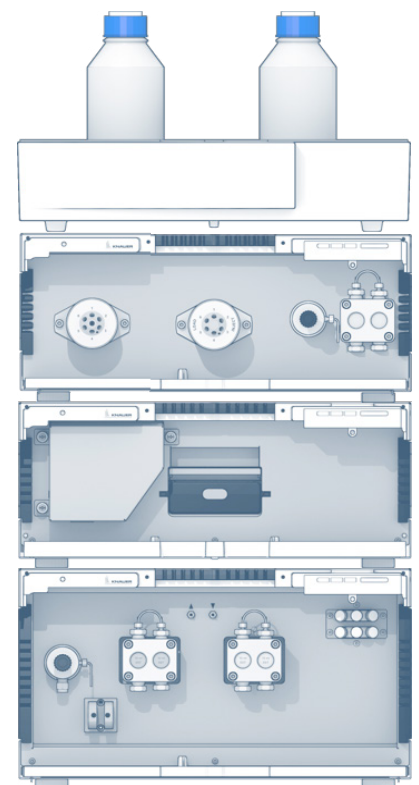

ADDITIONAL MATERIALS AND METHODS

Tab. A1 Method parameters

Eluent A	20 mM Na ₃ PO ₄ , 300 mM NaCl, 10 mM Imidazol, pH 7.4		
Eluent B	20 mM Na ₃ PO ₄ , 300 mM NaCl, 250 mM Imidazol, pH 7.4		
Gradient	Volume (mL)	% A	% B
	0	100	0
	18	100	0
	18.3	0	100
	33	0	100
	33.3	100	0
	60	100	0
Flow rate	3 mL/min	Detection wavelength	280 nm
Run temperature	RT	Run time	20 min
Injection volume	10 mL	Injection mode	Full loop

Tab. A2 System configuration

Instrument	Description	Article No.
Pump	AZURA® P6.1L HPG 50 mL ceramic	APH68FB
Assistent	AZURA® ASM 2.1L Right: 6P/Mpos 1/16" PEEK Middle: 6P/2Pos 1/16" PEEK Left: P4.1S 10 mL ceramic	
Detector	AZURA® MWD2.1L	ADB01
Flow cell	3 mm path length, 1/16", 2 µL volume, 300 bar, biocompatible	AMB18
Column	Tricorn™ 10/200 Säule, Chelating Sepharose™ Fast Flow	
Software	Purity Chrom Bio	A2650

RELATED KNAUER APPLICATIONS

[VBS0063](#) - Automated two step purification of mouse antibody IgG1 with AZURA Bio purification system

[VBS0064](#) - Comparison of IgG purification by two different protein A media

[VBS0067](#) - Automated two step purification of 6xHis-tagged GFP

[VBS0066](#) - Fast and sensitive size exclusion chromatography of IgG antibody

Ion Exchange Chromatography with AZURA® Bio purification system

Ulrike Krop, Kate Monks; applications@knauer.net
KNAUER Wissenschaftliche Geräte GmbH, Hegauer Weg 38, 14163 Berlin; www.knauer.net

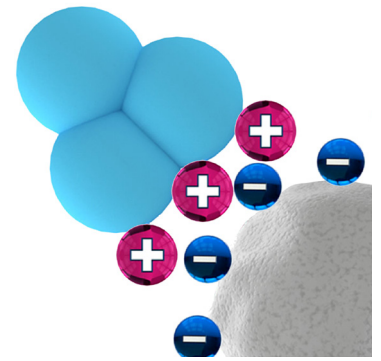

SUMMARY

Ion exchange chromatography is a popular technique for protein separation and purification. This application describes the separation of three model proteins by a salt gradient with the AZURA® Bio purification system.

INTRODUCTION

Ion exchange chromatography separates molecules based on the overall charge of the protein. The proteins of interest have a charge opposite to that of the resin. In the case of cation exchange chromatography, proteins have an overall negative charge while binding to a cationic column (Fig 1). The initial binding takes place under low ionic strength conditions. Elution is achieved by a salt gradient. By increasing the salt concentration proteins with a weak negative

charge elute first, while at higher salt concentrations proteins with a strong negative charge elute later. Ion exchange chromatography is frequently used for protein purification. A precise gradient formation is here one important parameter for a successful separation of proteins. AZURA Bio purification system supports all gradient methods including ion exchange chromatography.

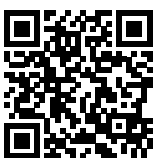

Ion Exchange Chromatography with AZURA® Bio purification system

RESULTS

Because of their isoelectric point (pI) the three proteins: α -Chymotrypsinogen A (pI 8.97), Cytochrome C (pI range from 10.0 - 10.5), and Lysozyme (pI 11.35) are well suited for the separation by cation exchange chromatography. At pH 6.1 all three model proteins have an overall negative charge and bind to the resin under low salt conditions. Remaining impurities and

potentially unbound proteins are washed from the column during the wash step. By slowly increasing the salt gradient, first α -Chymotrypsinogen A (**Fig 2** blue signal, Peak 1) eluted from the column followed by Cytochrome C (Peak 2) and Lysozyme (Peak 3). The salt gradient was monitored by the conductivity monitor (**Fig 2** red signal).

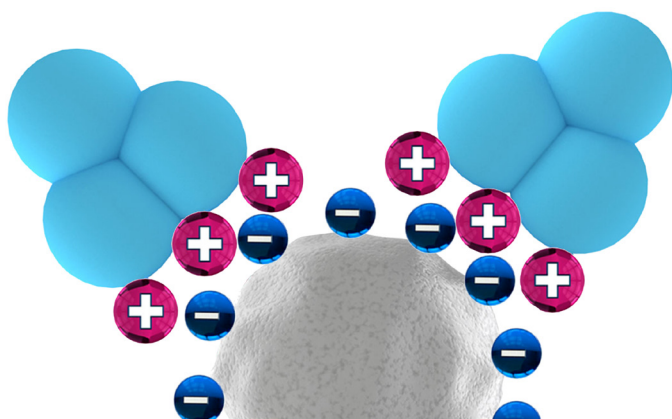

Fig. 1 Chromatogram of the separation of three model proteins with cation exchange chromatography, blue line - UV 280 nm signal, red line - conductivity signal, 1) peak containing α -Chymotrypsinogen A, 2) peak containing Cytochrome C 3) peak containing Lysozyme

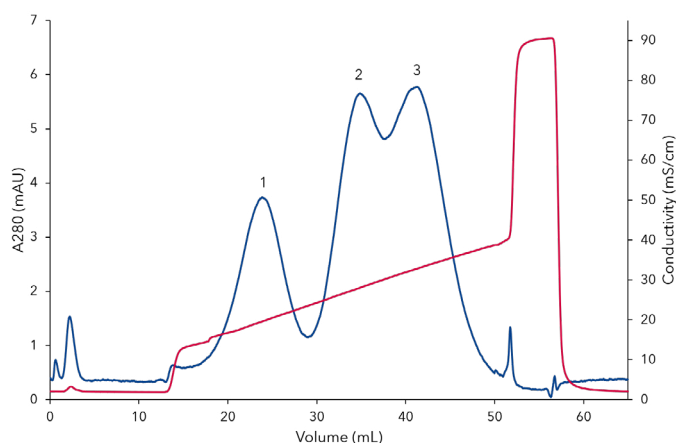
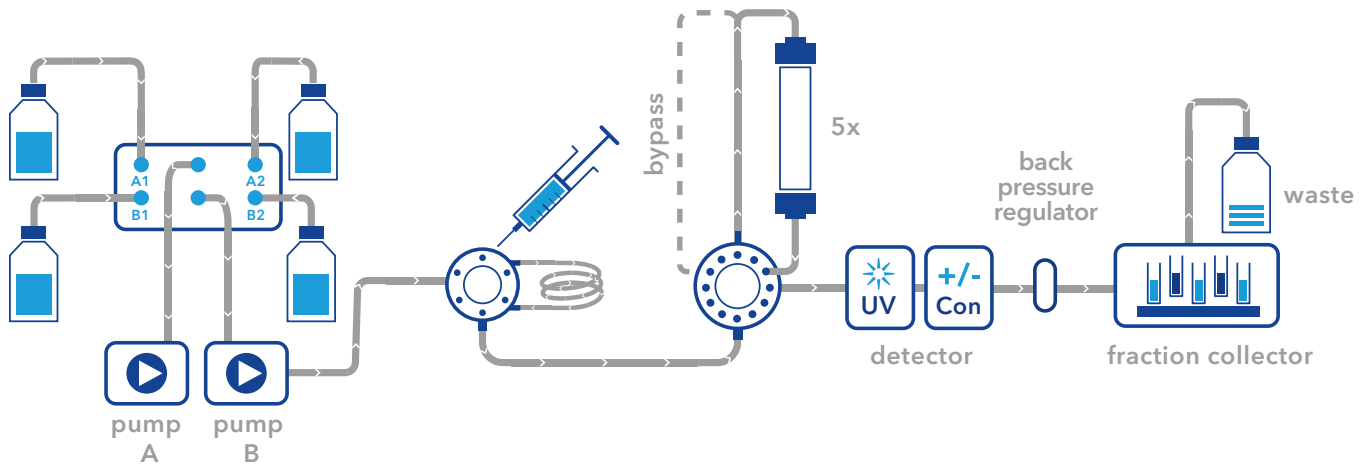

Fig. 2 Principle of cation exchange separation Proteins with different negative charges bind to the cation exchange resin. By increasing the salt concentration proteins with a weak negative charge elute first, while at higher salt concentrations proteins with a strong negative charge elute last.



**BUFFER SELECTION
& DELIVERY**

**SAMPLE
INJECTION**

**COLUMN
SELECTION**

DETECTION

**FRACTION
COLLECTION**

MATERIALS AND METHODS

In this application, an AZURA® Bio purification system consisting of AZURA P 6.1L HPG metal-free pump with 50 ml pump head; AZURA ASM 2.1L assistant module with UVD 2.1S detector and an injection valve; a bioinert multifunction selection valve; AZURA CM 2.1S conductivity monitor and Foxy R1 fraction collector was used. Prior to the run the cation exchange column (Sepapure SP FF6 1 mL) was equilibrated with buffer A (20 mM sodium phosphate buffer pH 6.1). The flowrate for the run was 1 mL/min. 100 µL protein mixture (α -Chymotrypsinogen A 0.33 mg/mL, Cytochrome C 0.33 mg/ml, Lysozyme 0.33 mg/mL) was injected. The column was washed with 5 mL buffer A to remove all unbound protein. The proteins were eluted with a linear gradient from 10% buffer B (20 mM sodium phosphate buffer pH 6.1, 1 M NaCl) to 40% B for 20 mL. The column was regenerated with a high salt wash of 5 mL buffer B 100% followed by a re-equilibration of the column with 10 mL of buffer A at a flowrate of 2 mL/min. The proteins were detected at 280 nm and conductivity signal was recorded to monitor the salt gradient.

CONCLUSION

The principle of ion exchange chromatography was illustrated. Three model proteins eluted under increasing salt concentrations from the cation exchange column. The AZURA Bio purification system is well suited for all gradient methods like ion exchange, hydrophobic interaction and reversed phase chromatography. Isocratic methods like size exclusion and affinity chromatography are as well supported. AZURA Bio purification system is the ideal system for your protein purification task.

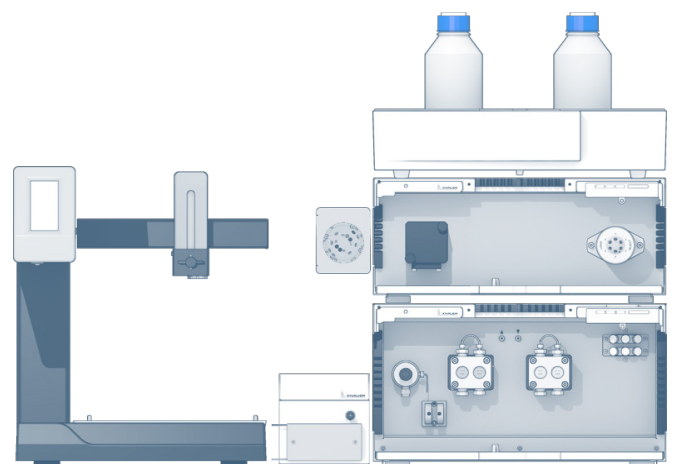

ADDITIONAL MATERIALS AND METHODS

Tab. A1 Method parameters

Eluent A	20 mM Sodium phosphate buffer pH 6.1		
Eluent B	20 mM Sodium phosphate buffer pH 6.1 + 1M NaCl		
Gradient	Volume [mL]	% A	% B
	0-5 step	100	0
	5-25 gradient	90	10
		60	40
	25-30 step	0	100
30-40 step	100	0	
Flow rate	1 mL/min from 25 mL: 2 mL/min	System pressure	0-1 bar
Column temperature	RT	Run time	40 min
Injection volume	100 µL	Injection mode	Injection valve
Detection UV	280 nm	Data rate	2 Hz

Tab. A2 System configuration

Instrument	Description	Article No.
Pump	AZURA P6.1L, HPG 50 mL	APH68FB
Assistant	AZURA ASM 2.1 L Left: UVD 2.1S Middle: - Right: 6-Port 2-Pos 1/16", PEEK	AYCALXEC
Valve	Bioinert multifunction selection valve	AWB00FC
Flow cell	Semi-preparative, UV Flow cell, 3mm, 1/16", 2 µL volume, biocompatible	A4045
Conductivity monitor	AZURA CM 2.1S	ADG30
Flow cell	Preparative up to 100 mL/min	A4157
Column	Sepapure SP FF6 1 mL	010X15RSPZ
Fraction collector	Foxy R1	A59100
Software	Purity Chrom Basic	A2650

RELATED KNAUER APPLICATIONS

[VBS0063](#) - Automated two - step purification of mouse antibody IgG1

[VBS0064](#) - Comparison of IgG purification by two different protein A media

[VBS0067](#) - Automated two-step purification of 6xHis-tagged GFP

[VBS0069](#) - Purification of Sulphydryl Oxidase

[VBS0071](#) - Comparison of two column sets for antibody purification in an automated two step purification process

[VBS0072](#) - Separation of proteins with cation exchange chromatography on Sepapure SP and CM

[VBS0073](#) - Separation of proteins with anion exchange chromatography on Sepapure Q and DEAE

[VBS0074](#) - Comparison of ion exchange columns

[VBS0075](#) - Group separation with Sepapure Desalting on AZURA Bio purification system

Comparison of two column sets for antibody purification in an automated two step purification process

Ulrike Krop, Kate Monks; applications@knauer.net
KNAUER Wissenschaftliche Geräte GmbH, Hegauer Weg 38, 14163 Berlin;
www.knauer.net

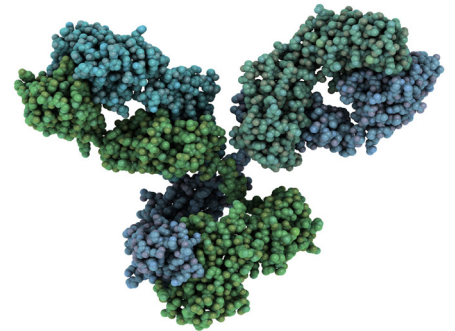

SUMMARY

This application compares the automated purification of antibodies with the AZURA® Bio purification 50 – Two Step Purification System with different columns. Capacity and yield of the purified proteins were compared and revealed no significant differences in the performances of the two investigated column sets.

INTRODUCTION

Antibodies play an important role in the biotechnology and pharmaceutical industry. They are used in a variety of applications where quality and purity of the antibodies is crucial. The most widely used technique for antibody purification is protein A affinity chromatography. It is a very efficient capture step and delivers highly clean protein. The antibodies are eluted under acidic conditions requiring an additional buffer exchange step. This desalting step requires in many

cases manual interaction. The AZURA Bio purification 50 – Two Step Purification System allows an automated purification without manual interaction. Various resins from different vendors are available for protein A affinity and desalting purification. The aim of this application was to compare different column sets for the affinity and desalting phase for this specific two step approach.

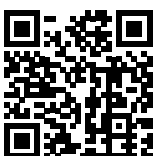

Comparison of two column sets for antibody purification in an automated two step purification process

RESULTS

Antibodies were purified from 100 μ L reconstituted human plasma by protein A affinity chromatography and a subsequent buffer exchange step. The chromatogram of the whole purification process is divided in two steps (Fig 1) During the first step, the sample is injected. All non-binding proteins flow through the column (Peak A). Next, all remaining impurities are washed from the affinity column. Elution takes place under low pH conditions (Peak B1). The eluted sample was stored in a sample loop and reinjected in step two on a desalting column. Finally, the elution peak (Peak B2) was collected. In the chromatogram two example

purifications with different column sets are depicted. The antibodies purified with the vendor X Protein A FF and Desalting columns (red signal) and Sepapure Protein A FF and Sepapure Desalting columns (blue signal) are comparable. An average of 0.37 ± 0.05 mg proteins was purified with the vendor X Protein A FF and Desalting column in comparison to an average yield of 0.41 ± 0.1 mg protein with Sepapure Protein A FF and Sepapure Desalting columns (Tab 1 suppl. Material). Finally, SDS-PAGE was performed to analyze the purity of the samples (Fig 2).

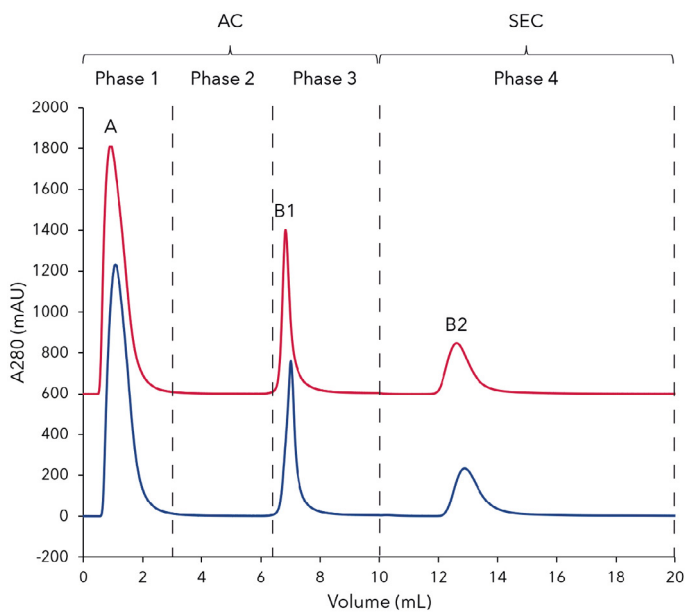

Fig. 1 Overlay of chromatograms of the two step antibody purification; Step 1 - Affinity chromatography (AC): Phase 1) Sample injection; Phase 2) Column washing; Phase 3) Elution of antibodies and parking in sample loop; Step 2 - Buffer exchange with desalting column: Phase 4) Elution of antibody; A - flow through of unbound protein; B1 - elution peak of antibodies from Protein A column; B2 - elution peak of antibodies from desalting column; Red signal : Purification with vendor X Protein A FF 1 mL and Desalting 5 mL column Blue signal: Purification with Sepapure Protein A FF 1 mL and Sepapure Desalting 5 mL column

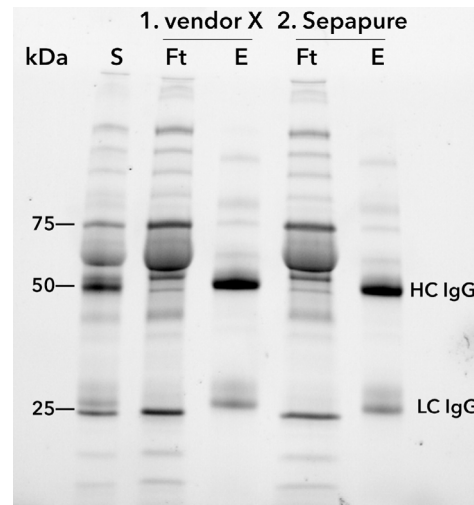

Fig. 2 SDS-PAGE at different purification steps; 1. Purification with vendor X Protein A FF 1 mL and Desalting 5 mL column, 2. Purification with Sepapure Protein A FF 1 mL and Sepapure Desalting 5 mL column, S) serum before purification; Ft) flow through, E) eluted antibodies (IgG) heavy chain (HC) and light chain (LC) after two step purification

MATERIALS AND METHODS

In this application an AZURA Bio purification 50 - Two Step Purification System was used. It consisted of an AZURA P 6.1L 50 mL HPG metal-free pump, 1st AZURA ASM 2.1L assistant module with 50 mL feed pump and two 6 port/2 position valves, 2nd AZURA ASM 2.1L with UVD 2.1S and two 6 port/2 position valves, column switching valve; conductivity monitor and a fraction collector. The protein A and Desalting columns were equilibrated with buffer A (20 mM Sodium Phosphate Buffer, pH 7.4). The flowrate for the 1 mL protein A columns was 1 ml/min and for the 5 mL Desalting columns was 5 mL/min. 100 μ L of reconstituted human plasma was injected on to the protein A column. The column was washed with buffer A. Antibodies were eluted with buffer B (0.1 M Glycin-HCL, pH 2.7). Via a threshold function the elution peak was parked in a 5 mL sample loop. Subsequently, the eluted protein was re-injected on to the desalting column for buffer exchange with buffer A. The eluted antibodies were collected with the fraction collector. The UV signal was measured at 280 nm and conductivity signal was recorded. Each purification was done with two column sets from each vendor in triplicates. The concentrations of the eluted protein from each individual run were determined with a NANODROP 2000 and analyzed by SDS-PAGE.

CONCLUSION

The AZURA Bio purification 50 - Two Step Purification System was used to analyze the automatic purification of human antibodies with two different sets of columns from different vendors. The yield and purity of the eluted antibodies was for both column sets comparable. With the two step purification system, no manual interaction was necessary between the first protein A affinity chromatography step and the second buffer exchange/desalting step. This setup can be adapted to other purification protocols and can be used for a variety of materials. In conclusion, the purification is quantitatively and qualitatively identical for both tested column materials in the two step system setup. The tested column materials are suitable for two step purification.

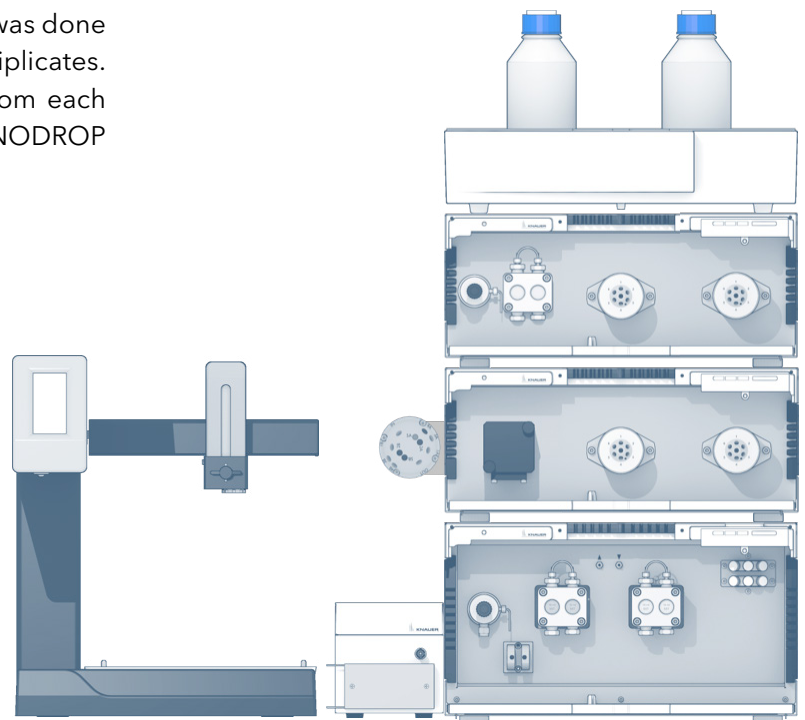

ADDITIONAL RESULTS

Tab.A1 Yield of the purified antibodies

Column set	Repetition	Protein A Column	Desalting column	Yield in mg	Mean
1	1	vondor X Protein A FF 1 mL	vondor X Desalting 5 mL	0.38	0.37 ±0.05
	2			0.40	
	3			0.45	
2	1	Sepapure Protein A FF 1 mL	Sepapure Desalting 5 mL	0.33	0.41 ±0.10
	2			0.32	
	3			0.36	
1	1	vondor X Protein A FF 1 mL	vondor X Desalting 5 mL	0.63	0.41 ±0.10
	2			0.38	
	3			0.38	
2	1	Sepapure Protein A FF 1 mL	Sepapure Desalting 5 mL	0.34	0.41 ±0.10
	2			0.34	
	3			0.41	

ADDITIONAL MATERIALS AND METHODS

Tab.A2 Method parameters

Eluent A	20 mM Sodium phosphate buffer pH 7.4		
Eluent B	100 mM Glycine, pH 2.7		
Gradient	Volume [mL]	% A	% B
AC Injection+Wash	0-5	100	0
AC Elution	5.02-10	0	100
SEC/Desalting	10.02-20	100	0
Flow rate	1 mL/min (Protein A) 5 mL/min (Desalting)	System pressure >3 bar	
Run temperature	RT	Run time	12 min
Injection volume	100 µL	Injection mode	Injection valve
Detection UV	280 nm	Data rate	2 Hz

Tab.A3 System configuration

Instrument	Description	Article No.
Pump	AZURA P6.1L, HPG 50 mL pump head, ceramic	APH68FB
Assistant 1	AZURA ASM 2.1 L Right: 6 Port 2 Pos valve 1/16", PEEK Middle: 6 Port 2 Pos valve 1/16", PEEK Left: P 4.1S, 50 mL pump head, ceramic	AYBLECEC
Assistant 2	AZURA ASM 2.1 L Right: 6 Port 2 Pos valve 1/16", PEEK Middle: 6 Port 2 Pos valve 1/16", PEEK Left: UVD2.1S	AYCAECEC
Flow cell	3 mm path length, 1/16", 2 µL volume, 300 bar, biocompatible	A4045
Conductivity monitor	AZURA CM 2.1S	ADG30
Flow cell	Preparative up to 100 mL/min	A4157
Column	Sepapure Protein A FF 1ml Sepapure Desalting 5 ml vondor X Protein A FF, 1ml vondor X Desalting, 5 ml	010X40USPZ 020X46OSPZ
Fraction collector	Foxy R1, microplates rack	A59100
Software	Purity Chrom Basic	A2650

RELATED KNAUER APPLICATIONS

[VBS0063](#) - Automated two - step purification of mouse antibody IgG1

[VBS0064](#) - Comparison of IgG purification by two different protein A media

[VBS0067](#) - Automated two step purification of 6xHis-tagged GFP

[VBS0070](#) - Ion Exchange Chromatography with AZURA® Bio purification system

Separation of proteins with cation exchange chromatography on Sepapure SP and CM

Ulrike Krop, Kate Monks; applications@knauer.net

KNAUER Wissenschaftliche Geräte GmbH, Hegauer Weg 38, 14163 Berlin; www.knauer.net



SUMMARY

Ion exchange chromatography is one of the most widely used FPLC techniques for protein separation and purification. Depending on the charge of the sample and the resin cation or anion exchange chromatography is used. This application describes an easy separation of model proteins and explains how cation exchange chromatography works.

INTRODUCTION

Ion exchange chromatography separates molecules according to type and strength of their charge. The isoelectric point (pI) is the pH where a protein or molecule has no net electrical charge. Depending on the pH of the buffer a protein has different surface charges in solution. At a pH below their pI proteins have positive charge and bind to negatively charged cation exchangers **Fig 1**). This interaction is used for the separation and purification of various proteins. By using a suitable pH and low salt conditions proteins bind to the resin in the initial step. Proteins are mostly separated with a linear salt gradient whereby the salt ions compete with the proteins for bindings sites. Proteins with weak ionic interactions are the first to elute from the column. In the case of cation exchange

chromatography, proteins that are less positively charged start to elute first. With an increase of the salt concentration proteins with stronger ionic interaction elute later from the column. Ion exchange resins are categorized as strong or weak exchangers. Strong ion exchange resins are fully charged over a wide range of pH levels, while weak ion exchangers have depending on the pH varying ion exchange capacity. Weak ion exchangers have different selectivity's compared to strong ion exchangers. This application describes the separation of Cytochrome C, Lysozyme, and Ribonuclease A on a weak and a strong cation exchanger and explains the principle of cation exchange chromatography.



Separation of proteins with cation exchange chromatography on Sepapure SP and CM

RESULTS

Cytochrome C (pI 10.3), Lysozyme (pI 11.35), and Ribonuclease A (pI 9.6) are proteins with relatively high pI values, which make them ideal candidates for cation exchange chromatography (Fig 2). All three proteins bind under low salt conditions to the resin. Ribonuclease A eluted first from the column due to its lower pI of 9.6 (Fig 2, peak 1). With an increasing gradient and

therefore increasing salt concentration Cytochrome C eluted as second peak while Lysozyme eluted as third peak. The identical protein mix was run on a weak (light blue signal Sepapure CM) and strong (dark blue signal Sepapure SP) cation exchangers showing the different selectivity of these two resins.

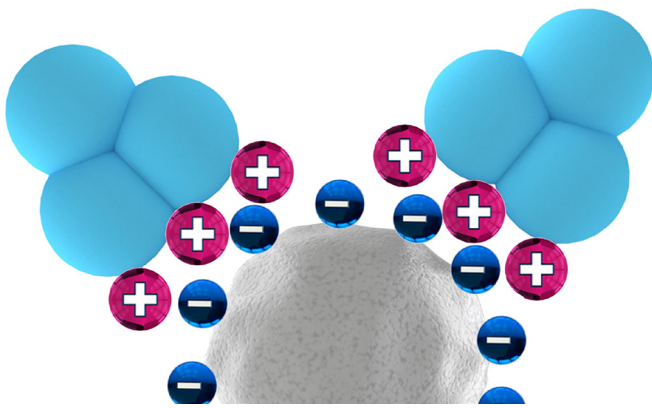

Fig. 1 Principle of cation exchange chromatography

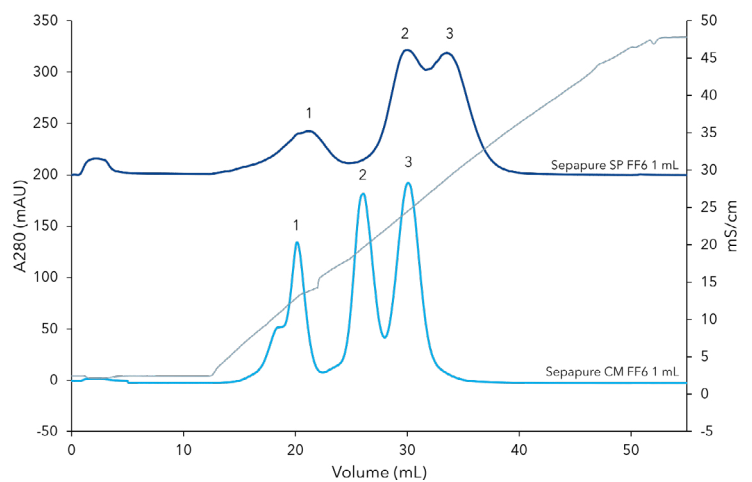

Fig. 2 Chromatograms of the separation of Ribonuclease A (1), Cytochrome C (2), and Lysozyme (3) with weak (light blue line) and strong (dark blue line) cation exchange chromatography columns, grey line: conductivity signal

MATERIALS AND METHODS

In this application, an AZURA® Bio purification system consisting of AZURA P 6.1L LPG metal-free pump with 10 mL pump head; AZURA ASM 2.1L assistant module with an injection valve and a single wavelength UV detector UVD 2.1S; AZURA CM 2.1S conductivity monitor and Foxy R1 fraction collector was used. Cytochrome C (0.4 mg/mL), Lysozyme (0.4 mg/mL) and Ribonuclease A (1 mg/mL) were diluted and mixed in buffer A (20 mM Sodium phosphate buffer pH 6.8) to the final concentration. Prior to the run the cation exchange columns (Sepapure SP FF6 1 mL and Sepapure CM FF6 1 mL) were equilibrated with buffer A. 2 ml of the sample was injected with a flowrate of 1 ml/min. The column was washed with 10 column volume (CV) of buffer A to remove all unbound protein. The proteins were eluted with a linear gradient over 40 CV up to 50 % buffer B (20 mM Sodium phosphate buffer pH 6.8, 1 M NaCl). The proteins were detected at 280 nm and conductivity signal was recorded to monitor the salt gradient.

CONCLUSION

Three model proteins with different surface charges eluted under increasing salt concentrations from the cation exchange columns illustrating the principle of cation exchange chromatography. The application demonstrates the different selectivity of Sepapure CM, a weak, and Sepapure SP, a strong, cation exchange column.

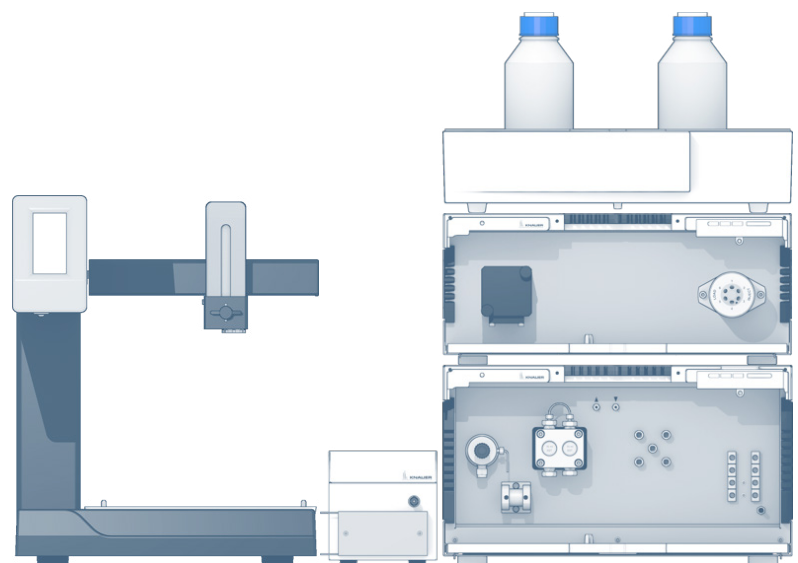

ADDITIONAL MATERIALS AND METHODS

Tab. A1 Method parameters

Eluent A	20 mM Sodium phosphate buffer pH 6.8		
Eluent B	20 mM Sodium phosphate buffer pH 6.8 + 1 M NaCl		
Gradient	Volume [mL]	% A	% B
	10 step	100	0
	40 gradient	50	50
	5 step	50	50
Flow rate	10 step	100	0
	1 mL/min (2 mL/min from 50 mL)	System pressure	>3 bar
Run temperature	RT	Run time	57.5 min
Injection volume	2 mL	Injection mode	Automatic injection valve
Detection UV	280 nm	Data rate	2 Hz

Tab. A2 System configuration

Instrument	Description	Article No.
Pump	AZURA P6.1L, LPG 10 mL PEEK PK	APH69EB
Assistant	AZURA ASM 2.1L Right: UVD 2.1S Middle: - Left: V2.1S 6 Port/6 Position PEEK 1/16"	AYCALXEC
Flow cell	3 mm semiprep, 2 µL, biocompatibel	A4045
Conductivity monitor	AZURA CM 2.1S	ADG30
Flow cell	Preparative up to 100 mL/min	A4157
Column	Sepapure SP FF6 1ml	010X15RSPZ
	Sepapure CM FF6 1ml	010X15QSPZ
Fraction collector	Foxy R1	A2650
Software	Purity Chrom	A59100

RELATED KNAUER APPLICATIONS

[VBS0070](#) - Ion Exchange Chromatography with AZURA® Bio purification system

[VBS0071](#) - Comparison of two column sets for antibody purification in an automated two step purification process

[VBS0073](#) - Separation of proteins with anion exchange chromatography on Sepapure Q and DEAE

[VBS0074](#) - Comparison of ion exchange columns

Separation of proteins with anion exchange chromatography on Sepapure Q and DEAE

Ulrike Krop, Kate Monks; applications@knauer.net

KNAUER Wissenschaftliche Geräte GmbH, Hegauer Weg 38, 14163 Berlin; www.knauer.net

SUMMARY

Ion exchange chromatography is one of the most widely used FPLC techniques for protein separation and purification. Depending on the charge of the sample and the resin cation or anion exchange chromatography is used. This application describes an easy separation of model proteins and explains how anion exchange chromatography works.

INTRODUCTION

Ion exchange chromatography separates molecules according to type and strength of their charge. The isoelectric point (pI) is the pH where a protein or molecule has no net electrical charge. Depending on the pH of the buffer a protein has different surface charges in solution. At a pH above their pI proteins have a negative charge and bind to positively charged resins such as anion exchangers (**Fig 1**). This interaction is used for the separation and purification of various proteins. By using a suitable pH and low salt conditions proteins bind to the resin in the initial step. Proteins are mostly separated with a linear salt gradient whereby the salt ions compete with the proteins for binding sites. Proteins with weak ionic interactions are the first to elute from the column. In the case of anion exchange chromatography, proteins that are less negatively charged start to elute first. With an increase of the salt concentration proteins with stronger ionic interaction elute later from the column. Ion exchange resins are categorized as strong or weak exchangers. Strong ion exchange resins are fully charged over a wide range

of pH levels, while weak ion exchangers have depending on the pH varying ion exchange capacity. Weak ion exchangers have different selectivities compared to strong ion exchangers. This application describes the separation of Conalbumin, α -Lactoglobulin and soy bean Trypsin inhibitor on a weak and a strong anion exchanger and explains the principle of anion exchange chromatography.

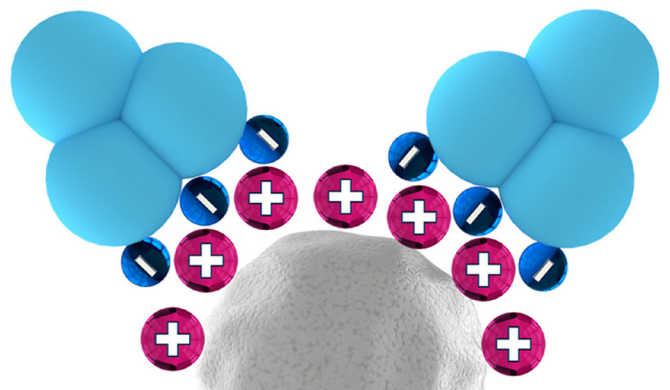
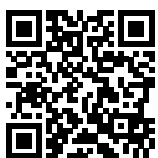

Fig. 1 Principle of anion exchange chromatography



Separation of proteins with anion exchange chromatography on Sepapure Q and DEAE

RESULTS

Conalbumin (pI 6.8), α -Lactoglobulin (pI 5.8), and soy bean Trypsin inhibitor Cytochrome C se A (pI 4.5) are proteins with relatively low pI values, which make them ideal candidates for anion exchange chromatography (Fig 2 & 3). All three proteins bind under low salt conditions to the resin. Conalbumin A eluted first from the column due to its highest pI within the group of separated proteins. With an increasing gradient and therefore increasing salt concentration α -Lactalbumin

eluted as second peak while soy bean Trypsin inhibitor eluted as third peak. The single protein standards were separated on each column to assign the peaks (Fig 2. A & B).

The identical protein mix was run on a weak (light blue signal Sepapure DEAE) and strong (dark blue signal Sepapure Q) anion exchangers showing the different selectivity of these two resins.

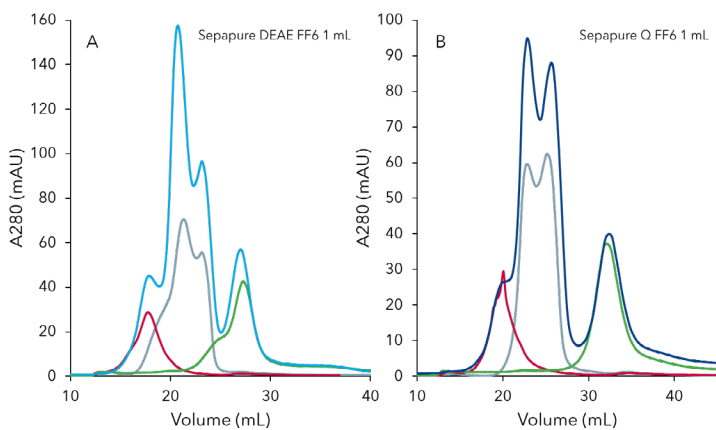

Fig. 2 Overlay of chromatograms on weak (A) and strong (B) anion exchange chromatography columns. Conalbumin (red line), α -Lactalbumin (grey line) and soy bean Trypsin inhibitor (green line), sample mix light blue for weak (A) and dark blue for strong (B) anion exchange chromatography columns

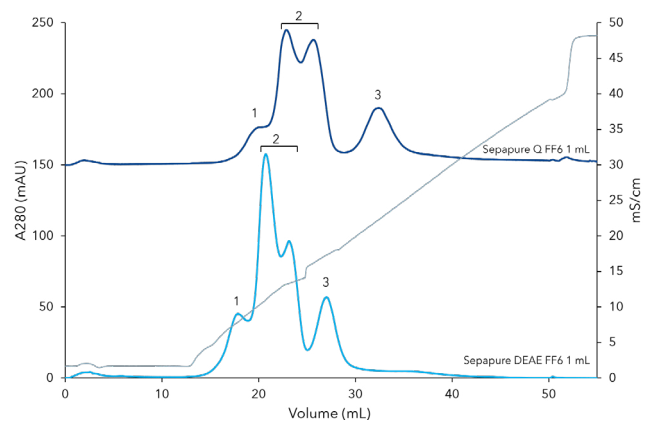

Fig. 3 Chromatograms of the separation of Conalbumin (1), α -Lactalbumin (2) and soy bean Trypsin inhibitor (3) with weak (light blue line) and strong (dark blue line) anion exchange chromatography columns, grey line: conductivity signal

MATERIALS AND METHODS

In this application, an AZURA Bio LC system consisting of AZURA P 6.1L LPG metal-free pump with 10 ml pump head; AZURA ASM 2.1L assistant module with an injection valve and a single wavelength UV detector UVD 2.1S; AZURA CM 2.1S conductivity monitor and Foxy R1 fraction collector was used. Conalbumin (0.2 mg/mL), α -Lactalbumin (0.4 mg/mL) and soy bean Trypsin inhibitor (0.6 mg/mL) were diluted and mixed in buffer A (20 mM Tris/HCl pH 7.4) to the final concentration. Prior to the run the anion exchange columns (Sepapure Q FF6 1 mL and Sepapure DEAE FF6 1 mL) were equilibrated with buffer A. 2 ml of the sample was injected with a flowrate of 1 ml/min. The column was washed with 10 column volume (CV) of buffer A to remove all unbound protein. The proteins were eluted with a linear gradient over 40 CV up to 40% buffer B (20 mM Tris/HCl pH 7.4, 1 M NaCl). The proteins were detected at 280 nm and conductivity signal was recorded to monitor the salt gradient.

CONCLUSION

Three model proteins with different surface charges eluted under increasing salt concentrations from the anion exchange columns illustrating the principle of anion exchange chromatography. The application demonstrates the different selectivity of Sepapure DEAE, a weak, and Sepapure Q, a strong, anion exchange resin.

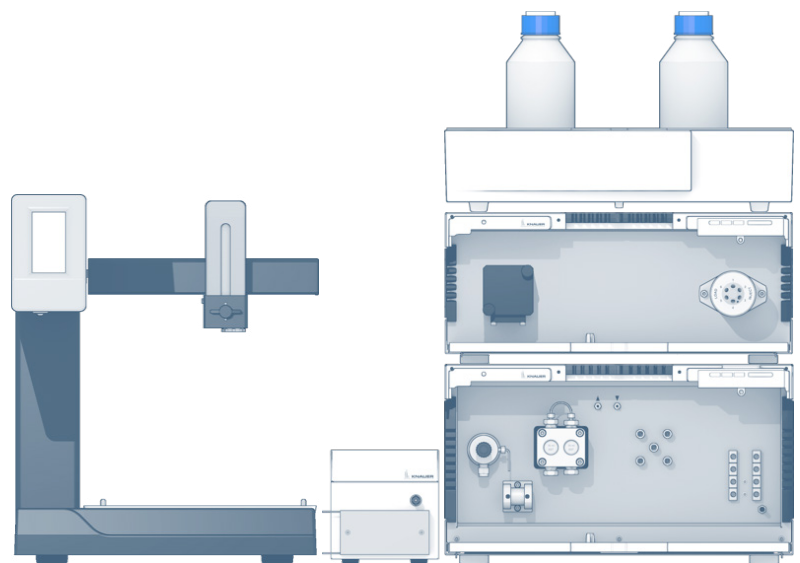

ADDITIONAL MATERIALS AND METHODS

Tab. A1 Method parameters

Eluent A	20 mM Tris/HCl pH 7.4		
Eluent B	20 mM Tris/HCl pH 7.4 + 1 M NaCl		
Gradient	Volume [mL]	% A	% B
	10 step	100	0
	40 gradient	60	40
	5 step	50	50
	10 step	100	0
Flow rate	1 mL/min	System pressure	>3 bar
Run temperature	RT	Run time	~60 min
Injection volume	2 mL	Injection mode	Automatic injection valve
Detection UV	280 nm	Data rate	2 Hz

Tab. A2 System configuration

Instrument	Description	Article No.
Pump	AZURA P6.1L, LPG 10 mL PEEK PK	APH69EB
Assistant	AZURA ASM 2.1L Right: UVD 2.1S Middle: - Left: V2.1S 6 Port/6 Position PEEK 1/16"	AYCALXEC
Flow cell	3 mm semiprep, 2 µL, biocompatibel	A4045
Conductivity monitor	AZURA CM 2.1S	ADG30
Flow cell	Preparative up to 100 mL/min	A4157
Column	Sepapure Q FF6 1ml	010X15HSPZ
	Sepapure DEAE FF6 1ml	010X15ISPZ
Fraction collector	Foxy R1	A2650
Software	Purity Chrom	A59100

RELATED KNAUER APPLICATIONS

[VBS0070](#) - Ion Exchange Chromatography with AZURA® Bio purification system

[VBS0071](#) - Comparison of two column sets for antibody purification in an automated two step purification process

[VBS0072](#) - Separation of proteins with cation exchange chromatography on Sepapure SP and CM

[VBS0074](#) - Comparison of ion exchange columns

Comparison of ion exchange columns

Ulrike Krop, Kate Monks; applications@knauer.net

KNAUER Wissenschaftliche Geräte GmbH, Hegauer Weg 38, 14163 Berlin; www.knauer.net

SUMMARY

Ion exchangers are used in a variety of protein purification protocols. This application compares equivalent columns, a weak and a strong anion exchanger as well as a weak and a strong cation exchanger from two different vendors. The columns were comparable in all assessed cases.

INTRODUCTION

Ion exchange chromatography is a powerful technique to separate proteins and is therefore used in numerous purification protocols. The column resins are modified by covalently bound functional groups. The choice of column modification influences the selectivity of the column. According to the charge of

the protein cation or anion exchange chromatography is the best method. In this application equivalent columns with different modifications from two vendors were compared.

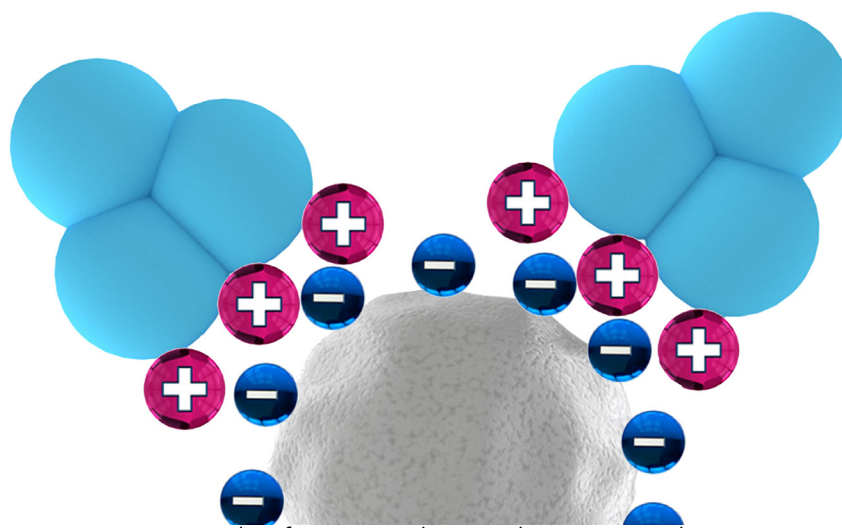

Principle of cation exchange chromatography

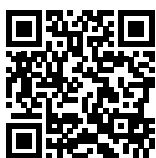

Comparison of ion exchange columns

RESULTS

Cytochrome C (pI 10.3), Lysozyme (pI 11.35) and Ribonuclease A (pI 9.6) are proteins with relatively high pI values, which make them ideal candidates for cation exchange chromatography (Fig 1 & 2) while for anion exchange chromatography Conalbumin (pI 6.8), α -Lactalbumin (pI 5.8) and soy bean Trypsin inhibitor Cytochrome C (pI 4.5) were used (Fig 3 & 4). All sample mixes bound under low salt conditions to

the resin and eluted under increasing salt concentrations. Identical protein mixes and method parameters were used for the comparison of the two vendors of weak and strong anion and cation exchangers. The peaks for the protein separation are comparable in all evaluated cases.

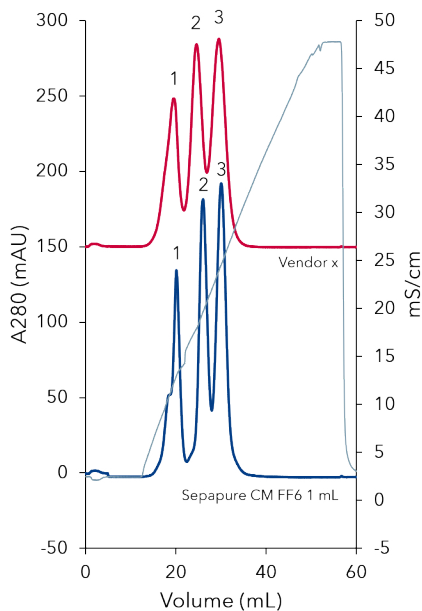

Fig. 1 Chromatograms of the separation of Ribonuclease A (1), Cytochrome C (2), and Lysozyme (3) with weak cation exchange chromatography columns, blue line: Sepapure CM FF6 1 mL, red line: comparable column from vendor x, grey line: conductivity signal

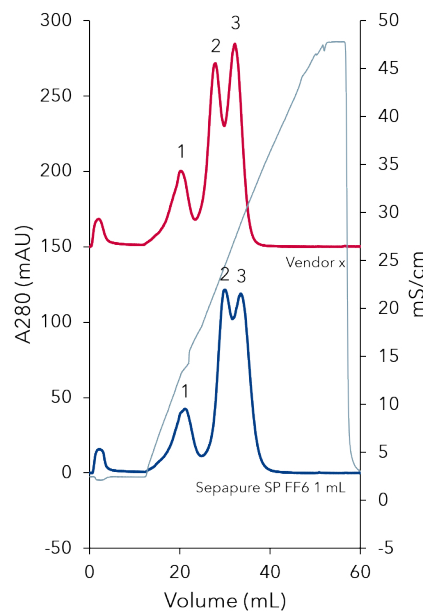

Fig. 2 Chromatograms of the separation of Ribonuclease A (1), Cytochrome C (2), and Lysozyme (3) with strong cation exchange chromatography columns, blue line: Sepapure SP FF6 1 mL, red line: comparable column from vendor x, grey line: conductivity signal

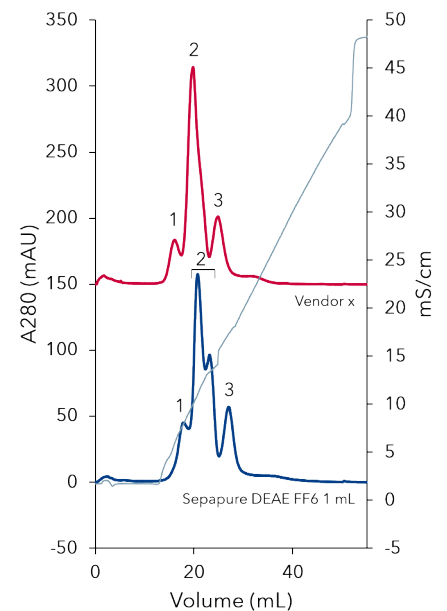

Fig. 3 Chromatograms of the separation of Conalbumin (1), α -Lactalbumin (2), and soy bean Trypsin inhibitor (3) with weak anion exchange chromatography columns, blue line: Sepapure DEAE FF6 1 mL, red line: comparable column from vendor x, grey line: conductivity signal

MATERIALS AND METHODS

In this application, an AZURA Bio purification system consisting of AZURA P 6.1L LPG metal-free pump with 10 mL pump head; AZURA ASM 2.1L assistant module with an injection valve and a single wavelength UV detector UVD 2.1S; AZURA CM 2.1S conductivity monitor and Foxy R1 fraction collector was used. For cation exchangers a mix of Cytochrome C (0.4 mg/mL), Lysozyme (0.4 mg/mL), and Ribonuclease A (1 mg/mL) was used. For anion exchangers a mix of Conalbumin (0.2 mg/mL), α -Lactalbumin (0.4 mg/mL), and soy bean Trypsin inhibitor (0.6 mg/mL) was used. Prior to the run the 1 mL columns (Sepapure SP, CM, Q, DEAE and the equivalent columns from vendor x)

were equilibrated in buffer A (for cation exchangers: 20 mM Sodium phosphate buffer pH 6.8; for anion exchangers: 20 mM Tris/HCl pH 7.4). 2 mL of the sample was injected with a flowrate of 1 mL/min. The columns were washed with 10 column volume (CV) of buffer A to remove all unbound protein. The proteins were eluted with a linear gradient over 40 CV up to 50% buffer B (20 mM Sodium phosphate buffer pH 6.8, 1 M NaCl) for the cation exchangers or up to 40% buffer B (20 mM Tris/HCl pH 7.4, 1 M NaCl) for the anion exchangers. The proteins were detected at 280 nm and conductivity signal was recorded to monitor the salt gradient.

CONCLUSION

Four different ion exchange columns types (SP, CM, Q, DEAE) from two vendors were compared. The equivalent columns were evaluated under identical conditions. The chromatograms of the protein separation are comparable in all assessed cases. The alternative columns can be considered as a replacement.

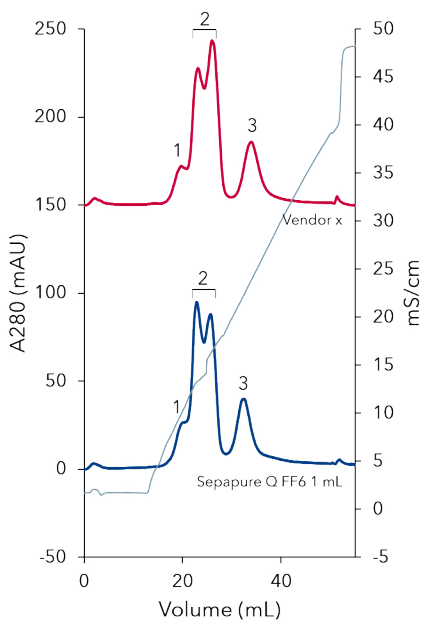
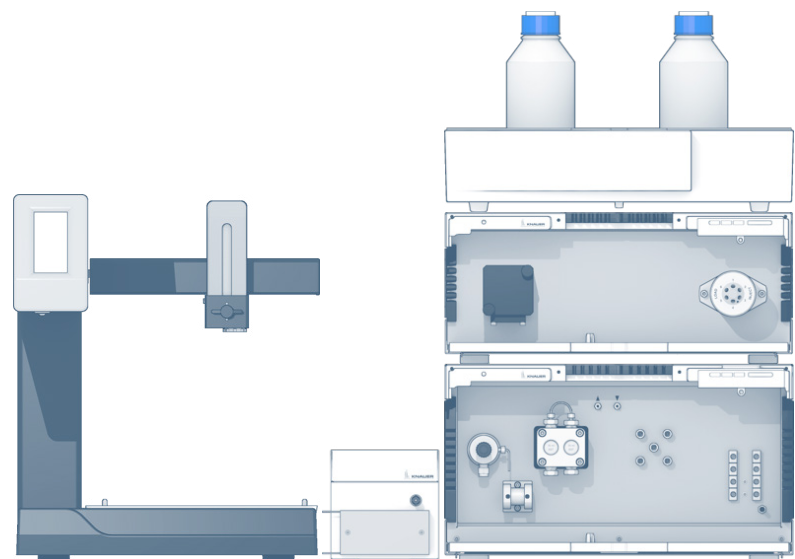

Fig. 4 Chromatograms of the separation of Conalbumin (1), α -Lactalbumin (2) and soy bean Trypsin inhibitor (3) with strong anion exchange chromatography columns, blue line: Sepapure Q FF6 1 mL, red line: comparable column from vendor x, grey line: conductivity signal



ADDITIONAL MATERIALS AND METHODS

Tab. A1 Method parameters for cation exchange chromatography runs

Eluent A	20 mM Sodium phosphate buffer pH 6.8		
Eluent B	20 mM Sodium phosphate buffer pH 6.8 + 1 M NaCl		
Gradient	Volume [mL]	% A	% B
	10 step	100	0
	40 gradient	50	50
	5 step	50	50
	10 step	100	0
Flow rate	1 mL/min (2 mL/min from 50 mL)	System pressure	>3 bar
Run temperature	RT	Run time	57.5 min
Injection volume	2 mL	Injection mode	Automatic injection valve
Detection UV	280 nm	Data rate	2 Hz

Tab. A2 Method parameters for anion exchange chromatography runs

Eluent A	20 mM Tris/HCl pH 7.4		
Eluent B	20 mM Tris/HCl pH 7.4 + 1 M NaCl		
Gradient	Volume [mL]	% A	% B
	10 step	100	0
	40 gradient	60	40
	5 step	50	50
	10 step	100	0
Flow rate	1 mL/min	System pressure	>3 bar
Run temperature	RT	Run time	~60 min
Injection volume	2 mL	Injection mode	Automatic injection valve
Detection UV	280 nm	Data rate	2 Hz

Tab. A3 System configuration

Instrument	Description	Article No.
Pump	AZURA P6.1L, LPG 10 mL PEEK PK	APH69EB
Assistant	AZURA ASM 2.1L Right: UVD 2.1S Middle: - Left: V2.1S 6 Port/6 Position PEEK 1/16"	AYCALXEC
Flow cell	3 mm semiprep, 2 µL, biocompatibel	A4045
Conductivity monitor	AZURA CM 2.1S	ADG30
Flow cell	Preparative up to 100 mL/min	A4157
Column	Sepapure Q FF6 1mL	010X15HSPZ
	Sepapure DEAE FF6 1mL	010X15ISPZ
	Sepapure SP FF6 1mL	010X15RSPZ
	Sepapure CM FF6 1mL	010X15QSPZ
	vendor x Q FF 1mL	010X15QSPZ
	vendor x DEAE FF 1mL	
	vendor x SP FF 1mL	
	vendor x CM FF 1mL	
Fraction collector	Foxy R1	A2650
Software	Purity Chrom	A59100

RELATED KNAUER APPLICATIONS

[VBS0070](#) - Ion Exchange Chromatography with AZURA® Bio purification system

[VBS0071](#) - Comparison of two column sets for antibody purification in an automated two step purification process

[VBS0072](#) - Separation of proteins with cation exchange chromatography on Sepapure SP and CM

[VBS0073](#) - Separation of proteins with anion exchange chromatography on Sepapure Q and DEAE

Group separation with Sepapure Desalting on AZURA® Bio purification system

Ulrike Krop, Kate Monks; applications@knauer.net

KNAUER Wissenschaftliche Geräte GmbH, Hegauer Weg 38, 14163 Berlin; www.knauer.net

SUMMARY

Size exclusion chromatography (SEC) is a popular FPLC techniques used for protein purification. Molecules are separated according to their size. Depending on the aim of the purification high resolution fractionation or group separation is used. This application describes group separation with Sepapure Desalting and shows examples for the separation of proteins from dyes and for protein desalting.

INTRODUCTION

Size exclusion chromatography (SEC) separates molecules according to their different molecular size. In comparison to other chromatography methods, in SEC the sample does not interact with the column matrix. The pore size of the SEC matrix allows the distribution of molecules of different sizes over the column bed and results in separation of the sample. Bigger molecules cannot enter the pores and pass through the column eluting first from the column. The smaller the molecules the better they can enter the pores and therefore have a longer way through the column resulting in a later retention time (**Fig 1**). SEC can be used for high resolution fractionation or group separation of molecules. In group separation the sample is separated into two groups: the high- and low-molecular weight fraction. Group separation can be used for protein purification to remove low molecular weight contaminations like dyes or for desalting and buffer exchange. Here, Fluorescein a popular fluorescent derivatization reagent used for labeling of biomolecules was removed after the labeling process by SEC. Another common use for SEC is desalting. Proteins of interest are not retained by the column and elute first. The small salt molecules elute later and

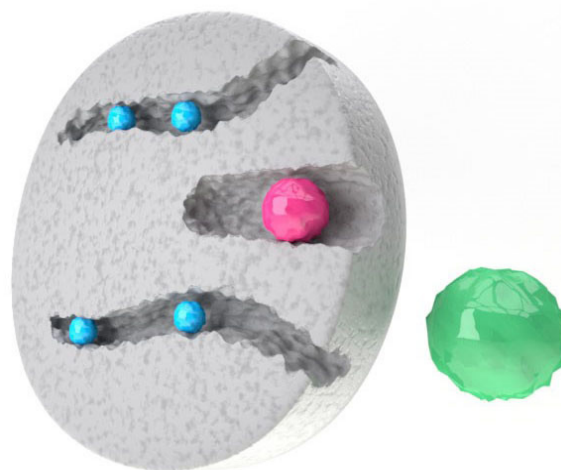
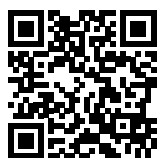

Fig. 1 Principle of size exclusion chromatography

are thereby separated from the sample. This mechanism can be used as well for buffer exchange. dyes or for desalting and buffer exchange. Here, Fluorescein a popular fluorescent derivatization reagent used for labeling of biomolecules was removed after the labeling process by SEC. Another common use for SEC is desalting. Proteins of interest are not retained by the column and elute first. The small salt molecules elute later and are thereby separated from the sample. This mechanism can be used as well for buffer exchange.



Group separation with Sepapure Desalting on AZURA® Bio purification system

RESULTS

In the first method bovine Serumalbumin (BSA) was separated from 5-Carboxyfluorescein (5-FAM) (**Fig 2**). The high molecular weight compound BSA (Peak 1) eluted before the low molecular weight molecule 5-FAM (Peak 2) from the Desalting column. In the second method (**Fig 3**) BSA (Peak 1) was separated from NaCl (Peak 2).

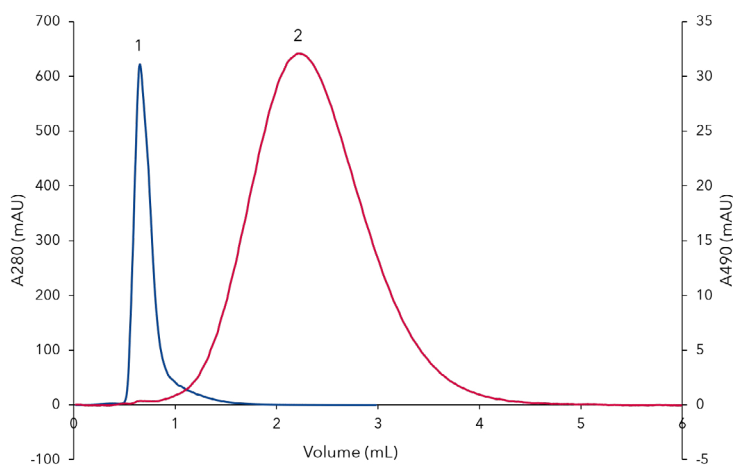

Fig. 2 Separation of BSA and 5-FAM. Peak 1 BSA, Peak 2 5-FAM, red signal UV 280nm, blue signal UV460 nm

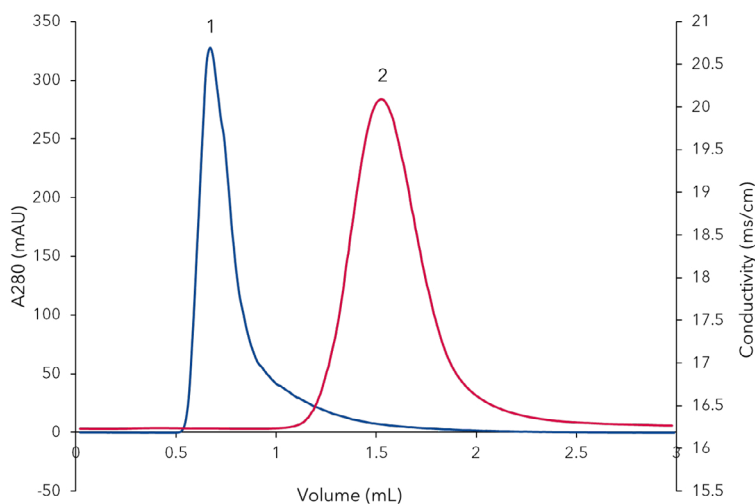

Fig. 3 Desalting of BSA. Peak 1 BSA, Peak 2 NaCl, blue signal UV280 nm, red signal conductivity

MATERIALS AND METHOD

In this application, an AZURA Bio purification system consisting of AZURA P 6.1L LPG metal-free pump with 10 mL pump head; AZURA ASM 2.1L assistant module with an injection valve and a single wavelength UV detector UVD 2.1S; AZURA CM 2.1S conductivity monitor and Foxy R1 fraction collector was used. 1 mg bovine serum albumin (BSA) and 3.75 μg 5-Carboxyfluorescein (5-FAM) was dissolved in PBS. Prior to the run the 1 mL Sepapure Desalting column was equilibrated with PBS. 50 μl of the sample was injected with a flowrate of 1 mL/min. BSA was detected at 280 nm, 5-FAM was detected at 490nm and conductivity signal was recorded to monitor the salt peak.

CONCLUSION

Sepapure Desalting can be used for the separation of small from large molecules. BSA was separated from a fluorescent dye. Additionally, the buffer was changed by a desalting step. These two examples illustrated the principle of group separation by SEC.

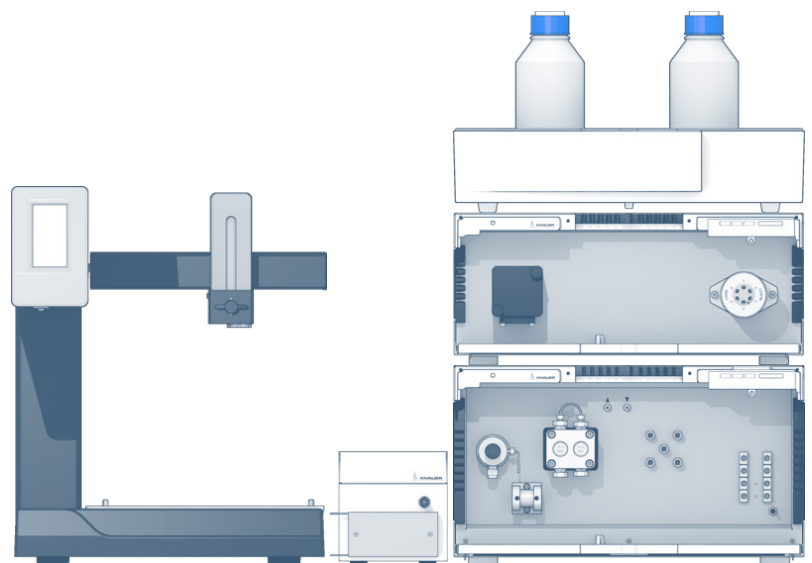

ADDITIONAL MATERIALS AND METHODS

Tab. A1 Method parameters

Buffer A	Washing buffer: PBS (phosphate buffered saline)		
Gradient	isocratic		
Flow rate	1 mL/min	System pressure	<3 bar
Column temperature	RT	Run time	6 min
Injection volume	Each 50 µL	Injection mode	-
Detection wavelength	280 nm 490 nm	Data rate	2 Hz

Tab. A2 System configuration

Instrument	Description	Article No.
Pump	AZURA P6.1L LPG, 10 ml PEEK	APH69EB
Assistant	AZURA ASM 2.1L Right: UVD2.1S Middle: - Left: V2.1S 6 Port/ 2Position	AYCALXEC
Flow cell	3 mm semiprep, 2 µL biocompatible	A4045
Conductivity monitor	CM 2.1S	ADG30
Flow cell	Preparative up to 100 mL	A4157
Column 2	Sepapure Desalting 5 mL	020X460SPZ
Fraction collector	FoxyR1	A59100
Software	PurityChrom, standard licence	A2650

RELATED KNAUER APPLICATIONS

[VBS0070](#) - Ion Exchange Chromatography with AZURA® Bio purification system

[VBS0071](#) - Comparison of two column sets for antibody purification in an automated two step purification process

[VBS0072](#) - Separation of proteins with cation exchange chromatography on Sepapure SP and CM

[VBS0073](#) - Separation of proteins with anion exchange chromatography on Sepapure Q and DEAE

[VBS0074](#) - Comparison of Ion Exchange columns

Quantitative determination of primary aromatic amines in recycled cold-cure and flexible foams

Juliane Böttcher, Kate Monks; applications@knauer.net
KNAUER Wissenschaftliche Geräte GmbH, Hegauer Weg 38, 14163 Berlin;
www.knauer.net



SUMMARY

A reliable method for the quantification of aryl amines in cold-cure and flexible foams from recycled mattresses is described in the following application. The focus was set on two substances, 2,4-diaminotoluene (TDA) and 4,4-diaminodiphenylmethane (DAPM), which are mandatory to be determined before processing the recycled foam due to their carcinogenic properties.

INTRODUCTION

Cold-cure and flexible foams used for the production of mattresses are made of polyurethane synthetics. During the synthesis of urethanes, which are the basis for polyurethanes, different intermediate products are formed. Two of these products occurring in the process are DAPM and TDA. Both substances are classified as carcinogenic. Furthermore TDA is presumed

to be teratogenic and mutagenic. When recycling the cold-cured and flexible foams it is necessary to determine the concentration of these compounds before reusing the foams. Referring to OEKO-TEX® Standard 100 a limit value of 20 mg/kg for aryl amines is appointed [1].

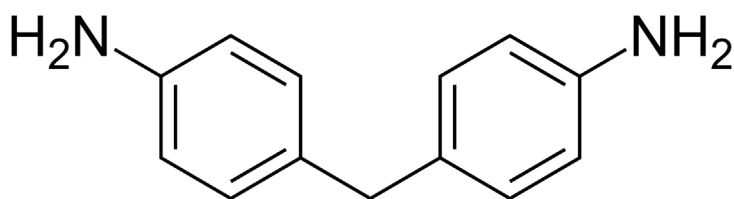

2,4-Diaminotoluene

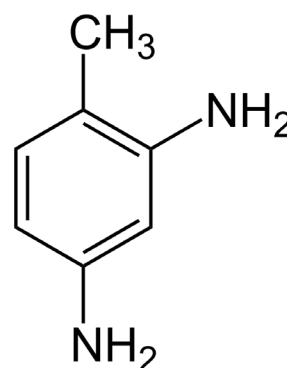

4,4-Diaminodiphenylmethane



Quantitative determination of primary aromatic amines in recycled cold-cure and flexible foams

RESULTS

For the quantification a calibration was made. Therefore a mixed standard of DAPM and TDA at five different concentrations was used. For both components a correlation coefficient of $R^2=0.999$ was achieved. Exemplary one sample of flexible foam was selected and spiked with standard to a concentration of

0.1 mg/mL. **Fig 1** shows the sample measurement and **Fig 2** shows an overlay of the sample (red) and spiked sample (blue) of flexible foam. The limit of detection (LOD) was determined with 0.63 $\mu\text{g/mL}$ for TDA and 0.67 $\mu\text{g/mL}$ for DAPM.

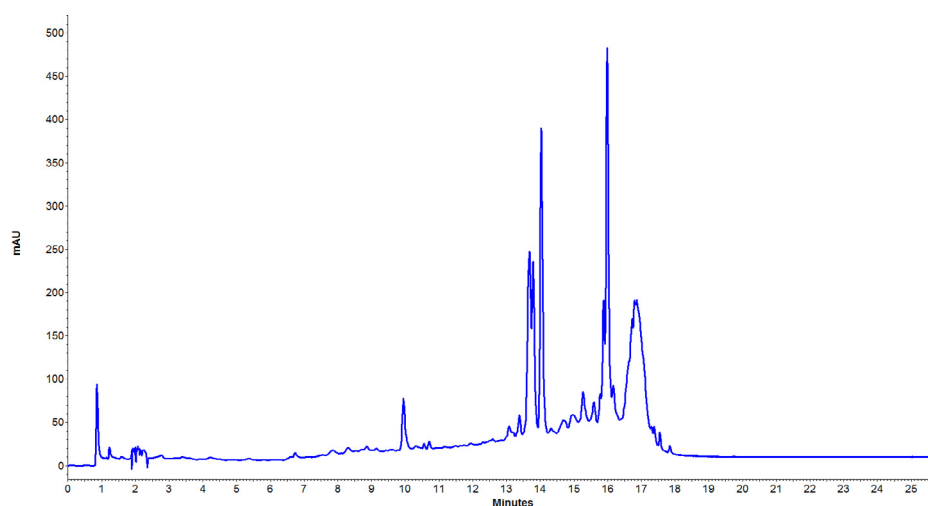

Fig.1 Sample of flexible foam (18 mg/mL)

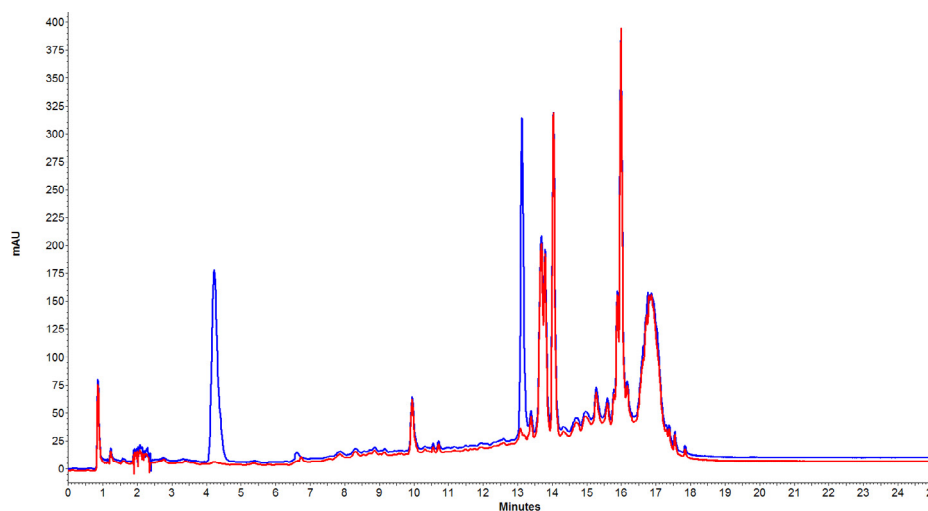

Fig.2 Overlay of sample (red) and spiked sample (blue) of flexible foam

MATERIALS AND METHODS

An AZURA® Analytical HPLC Plus system for a pressure range up to 700 bar was used for this application. It consisted of an AZURA P 6.1L LPG pump, an autosampler 3950, an AZURA CT 2.1 column thermostat and an AZURA MWD 2.1L multiwavelength detector. The analytical method was run with a step gradient at a flow rate of 1.0 mL/min. The mobile phase was a mixture of water and acetonitrile, both with 0.1 % triethylamine as mobile phase modifier. The column thermostat was set to 25 °C and the detector recorded at 290 nm. The column that was used was filled with ProntoSIL 120-3 C8 ace EPS silica.

CONCLUSION

With the developed method and the AZURA HPLC Plus system it was possible to perform a rapid quantitative analysis of 2,4-diaminotoluene and 4,4-diaminodiphenylmethane without time consuming sample preparation. Even a complex matrix such as the recycled cold-cured and flexible foams can be determined robust and reproducible with the specified method parameters.

REFERENCES

- [3] https://www.oeko-tex.com/de/business/certifications_and_services/ots_100/ots_100_limit_values/ots_100_limit_values.html



ADDITIONAL RESULTS

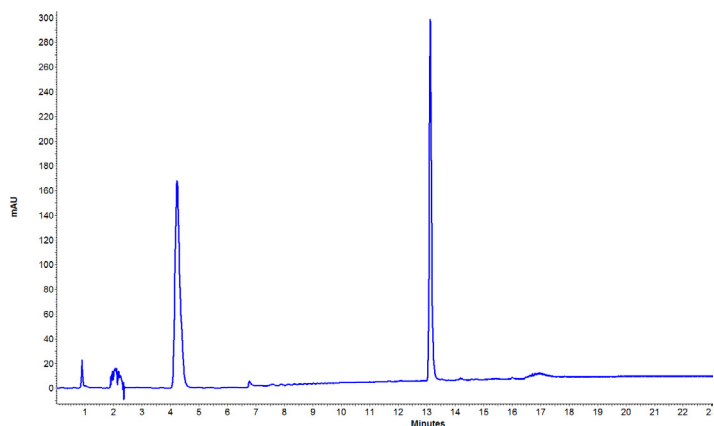

Fig. A1 Mixed standard of TDA and DAPM (both 0.1mg/mL)

ADDITIONAL MATERIALS AND METHODS

Tab. A1 Method parameters

Eluent A	H ₂ O _{dd} +0.1 % TEA		
Eluent B	Acetonitrile+0.1 % TEA		
Gradient	Time [min]	% A	% B
	0	95	5
	5	95	5
	15	35	65
	15.02	0	100
	25	0	100
	25.02	95	5
35	95	5	
Flow rate	1 mL/min	System pressure	ca. 190 bar
Column temperature	25 °C	Run time	35 min
Injection volume	10 µL	Injection mode	Full loop
Detection wavelength	290 nm	Data rate	20 Hz
		Time constant	0.05 sec

Tab. A2 System configuration & data

Instrument	Description	Article No.
Pump	AZURA® P 6.1L LPG, 10 ml, SSt	APH35EA
Autosampler	Autosampler 3950	A50070
UV Detector	AZURA® MWD 2.1L	ADB01
Flow cell	LightGuide 10 mm, 2 µL	AMC19
Thermostat	AZURA® CT 2.1	A05852
Eluent tray	AZURA® E 2.1L	AZC00
Column	Vertex Plus Column 150 x 4.6 mm ProntoSIL 120-3 C8 ace EPS with precolumn	15VF08APSG
Software	OpenLAB CDS EZChrom Edition	A2600-1

RELATED KNAUER APPLICATIONS

[VCH0016](#) - Determination and quantification of acrylic acid derivatives

Determination and quantification of acrylic acid derivatives

Juliane Böttcher, Kate Monks; applications@knauer.net
KNAUER Wissenschaftliche Geräte GmbH, Hegauer Weg 38, 14163 Berlin; www.knauer.net



SUMMARY

We are constantly exposed to acrylic monomers as part of our everyday lives. Diverse forms can be found at home, at work, on the street, or at the supermarket. End products based on acrylic monomers are utilized in many products from paints and lacquers to adhesives, water treatment products, and plastics to detergents, or textile fibers. In this application, four common acrylic acid derivatives were quantified with the AZURA® HPLC Plus system.

INTRODUCTION

Acrylate monomers used to form acrylate polymers are based on the structure of acrylic acid or are derivatives of it. Acrylic acid and some acrylate oligomers and monomers can affect human health as eye and skin irritants. Residual monomers might be exposed to consumers and that is why the content of residual

monomers in acrylic polymers needs to be examined. Methyl methacrylate, 2-hydroxyethyl methacrylate, ethylhexyl acrylate, and isobornyl acrylate are examples of acrylic acid derivatives and were determined in this application.

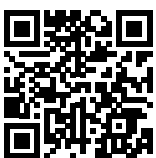

Determination and quantification of acrylic acid derivatives

RESULTS

A mixed standard of the four acrylate monomers was used to determine a calibration with the following concentrations for each compound: 0.001 mg/mL, 0.002 mg/mL, 0.004 mg/mL, 0.01 mg/mL, and 0.02 mg/mL. The four detected peaks are baseline separated. **Fig 1** shows the chromatogram of the acrylate mix standard

at a concentration of 0.01 mg/mL. For all compounds the limit of detection (LOD, S/N=3) and the limit of quantification (LOQ, S/N=10) were calculated based on the measurement of the lowest calibration concentration. **Tab 1** displays a summary of the determined quantification results.

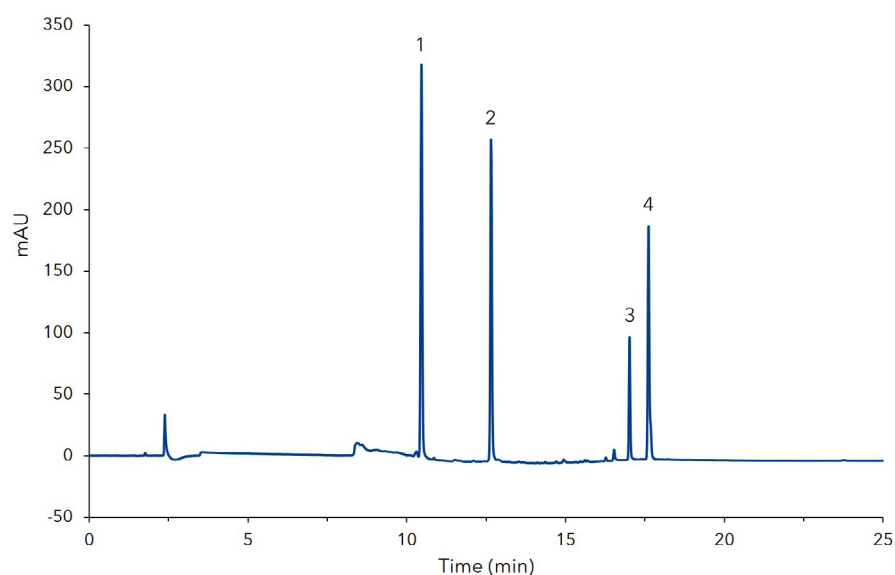

Fig. 1 Measurement of standard mix (0.01 mg/mL); 1) 2-Hydroxyethyl methacrylate, 2) Methyl methacrylate, 3) Ethylhexyl acrylate, 4) Isobornyl acrylate

Tab. 1 LOD and LOQ of acrylic monomers

Substance	LOD ($\mu\text{g/mL}$)	LOQ ($\mu\text{g/mL}$)
2-Hydroxyethyl methacrylate	0.022	0.07
Methyl methacrylate	0.032	0.11
Ethylhexyl acrylate	0.075	0.25
Isobornyl acrylate	0.042	0.14

MATERIALS AND METHODS

All standards were provided by the Fraunhofer-Institut für Fertigungstechnik und Angewandte Materialforschung IFAM [2]. For this application an AZURA analytical system was used which consisted of an AZURA P 6.1L quaternary LPG pump, an AZURA DAD 6.1L diode array detector, an AZURA CT 2.1 column thermostat and an AZURA AS 6.1L autosampler. The flow was set to 1 mL/min at a column temperature of 40 °C. The detection wavelength was set to 210 nm. The sampling rate was set to 1 Hz and the time constant to 0.2 s. 10 µl of the standards were injected. The column with the dimensions 150 x 4.6 mm ID with pre-column was filled with Eurospher II 100-3 C18 silica.

CONCLUSION

The developed gradient consisted of two different elution steps. The first gradient step from water to acetonitrile separates the acrylic monomers. In the second step from acetonitrile to tetrahydrofuran, polyacrylates potentially present in the polyacrylate matrix can be eluted/washed from the column. These two steps are useful when both polar and non-polar acrylates are to be separated. Furthermore, this simplifies the sample preparation which in the end leads to a reduced analysis time.

REFERENCES

[1] http://www.acrylicmonomers.basf.com/portal/8/en/dt.jsp?page=basf_acrylic_monomers

[2] Fraunhofer-Institut für Fertigungstechnik und Angewandte Materialforschung IFAM

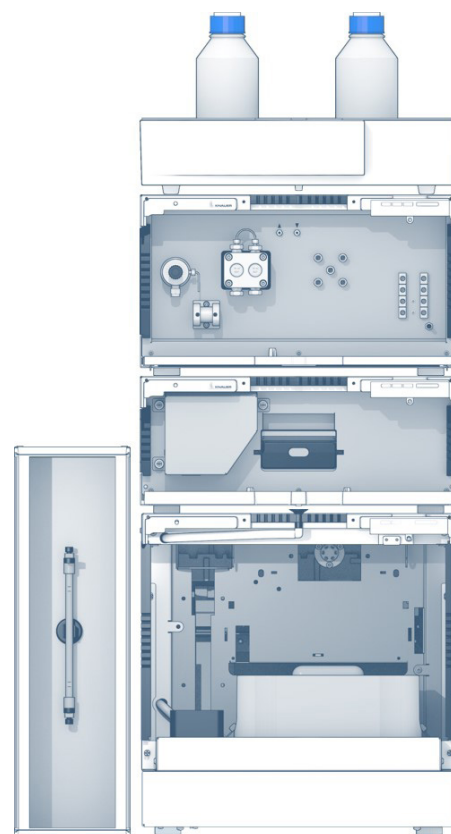

ADDITIONAL MATERIALS AND METHODS

Tab. A1 Method parameters

Eluent A	Water + 0.1% phosphoric acid			
Eluent B	Acetonitrile			
Eluent C	Tetrahydrofuran			
Gradient	Time (min)	% A	% B	% C
	0	100	0	0
	5	100	0	0
	15	0	100	0
	25	0	100	0
	28	0	0	100
	38	0	0	100
	41	0	100	0
	51	0	100	0
	51.1	100	0	0
	60	100	0	0
Flow rate	1 mL/min	Run time	60 min	
Column temperature	40 °C	Injection mode	Partial loop	
Injection volume	10 µL	Data rate	1 Hz	
Detection wavelength	210 nm	Time constant	0.2 s	

Tab. A2 System configuration & data

Instrument	Description	Article No.
Pump	AZURA® P6.1L, LPG 10 mL	APH34EA
Autosampler	AZURA® AS 6.1L	AAA00AA
Detector	AZURA® DAD 2.1L	ADC01
Flow cell	PressureProof Cartridge 10mm, 10µL	AMC38
Column	Eurospher II 100-3 C18, Vertex Plus Column 150 x 4.6 mm ID with precolumn	15VE181E2G
Thermostat	AZURA® CT 2.1	A05852
Software	ClarityChrom 7.2	A1670-11

RELATED KNAUER APPLICATIONS

[VCH0015](#) - Quantitative determination of primary aromatic amines in recycled cold-cure and flexible foams

Systematic HPLC method development and robustness evaluation of 13 carbonyl DNPH derivatives using DryLab®

Lilit Avagyan, Kate Monks; applications@knauer.net
KNAUER Wissenschaftliche Geräte GmbH, Hegauer Weg 38, 14163 Berlin; www.knauer.net



SUMMARY

In the monitoring of industrial air, the determination of carbonyl (aldehyde and ketone) emissions is crucial to prevent respiratory, pulmonological, autoimmune diseases, and cancer. According to the analytical method described in the DIN ISO 16000-3 [1], the carbonyls must be converted to their corresponding hydrazones with 2,4-dinitrophenylhydrazin (DNPH) in order to be detected via UV detector and analyzed by reversed phase HPLC. Here, the DryLab® software was used for method optimization to separate of 13 carbonyl derivatives in a standard mixture with the AZURA® HPLC system and the DNPH-column.

INTRODUCTION

The main objective of method optimization in HPLC is to define the appropriate conditions for robust, precise, and reproducible analysis. In order to save resources, a computer assisted method development can be a valuable tool. For the characterization of carbonyl content in air samples, commonly a standard mixture of 13 aldehyde and ketone DNPH derivatives is used. For precise analysis a good separation of all 13 components has to be achieved. Here, the

chromatography modelling software DryLab® with 3D Cube option was used for the optimization of the analysis of the carbonyl standard mixture. The investigation of the combined influence of gradient time, temperature and ternary eluent composition on critical resolution enabled the development of robust method conditions. Furthermore, the robustness space was investigated *in silico* and verified experimentally with a high degree of agreement.



Systematic HPLC method development and robustness evaluation of 13 carbonyl DNPH derivatives using DryLab®

RESULTS

The separation of 13 carbonyls was analyzed according to the method described in DIN ISO 16000-3 [1]. The obtained chromatogram from this experiment resulted 11 peaks (Fig. 1). The peaks representing acetone-DNPH, Acroleine-DNPH, 2-Butanone-DNPH, Methacroleine-DNPH, and butyraldehyde-DNPH were not separated. In order to optimize method parameters in silico, DryLab requires measurements under 12 conditions (Fig. 2). The measurements were conducted as described below. The obtained chromatograms were fed into the DryLab software resulting in the Method Operation Design Region (MODR). The red regions in the cube represent the optimal

chromatographic conditions (Fig. 3). The selection of the best parameters from the predicted data pull are based on high resolution values. The optimal separation method was established with the solvent composition water and acetonitrile, with a column temperature at 22 °C and a gradient time of 14 min. As the results show (Fig. 4) the baseline separation of acetone-DNPH and acroleine-DNPH was reached with the resolution value of 2.69 (see suppl. results Tab. A1). The lowest resolutions were obtained between peak pairs 2-Butanone-DNPH, Methacroleine-DNPH (1.27) and Methacroleine-DNPH, n-Butylaldehyde (1.29).

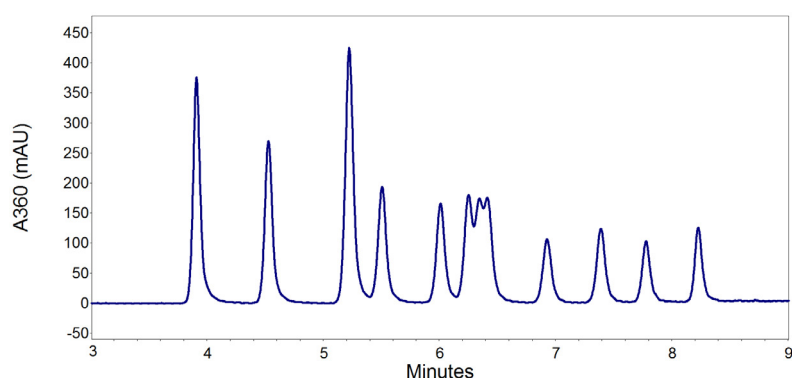

Fig. 1 Chromatogram of 13 carbonyls, measured according to ISO DIN 16000-3 method with the DNPH column with the DNPH column

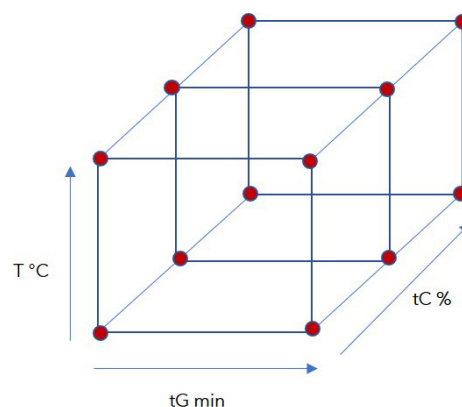

Fig. 2 DryLab 3D Cube with 12 red pointed measurement conditions

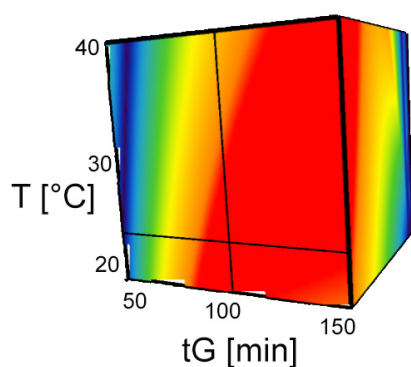

Fig. 3 MODR Method Operation Design Region

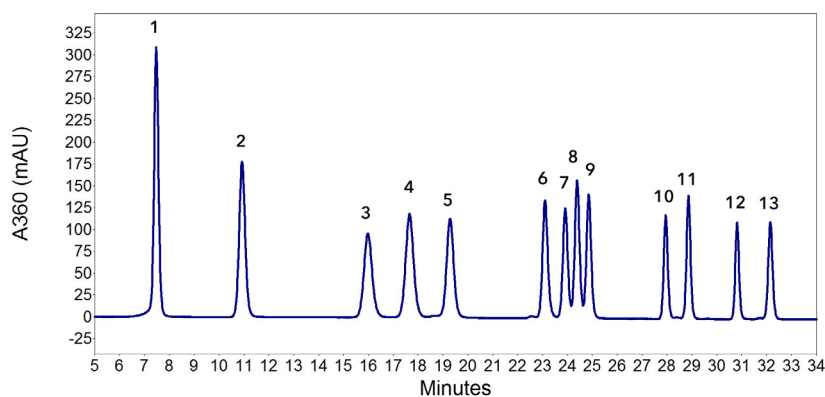

Fig. 4 Chromatogram of 13 carbonyls, measured according to DryLab® predicted method with the DNPH column

MATERIALS AND METHODS

The HPLC system includes the pump AZURA® P 6.1L HPG, detector AZURA® DAD 6.1L, autosampler AZURA® AS 6.1L, column thermostat AZURA® CT 2.1. The method separation, described in DIN ISO 16000-3 [1] and following method optimization was performed on DNPH-column (150 x 3 mm). The standard with 13 aldehyde and ketone derivatives, dissolved in acetonitrile was obtained from SigmaAldrich and was diluted to a concentration of 1 µg/mL in acetonitrile. For method optimization, the DryLab® (Version 4) modeling software (Molnár-Institute, Berlin) was used. The optimal separation conditions were predicted based on 12 chromatograms. The measurements were performed by three different mobile phase compositions (100% MeOH, 50:50 MeOH:Acetonitrile, 100% Acetonitrile). Each composition was used for measurements at two different temperatures and gradient times, namely 20 and 40 °C, and 30 and 90 min respectively. The analysis of chromatograms was performed by the using of OpenLab chromatographic software. For the method optimization the column parameters, initial gradient conditions and dwell volume of the system were programmed in the DryLab® software. The chromatographic data files were converted in to AIA (*.CDF) format and loaded in the DryLab® for the calculation.

REFERENCES

[1] DIN ISO 16000-3; Indoor air - Part 3: Determination of formaldehyde and other carbonyl compounds in indoor air and test chamber air - Active sampling method (ISO 16000-3:2011)

CONCLUSION

The DryLab® software is an important part in the HPLC method optimization. Our results show, that it makes possible to define optimal separation conditions without performing of numerous unnecessary measurements. This software helps to save the time, to reduce the consumption of materials and perform ecological 'green' HPLC.

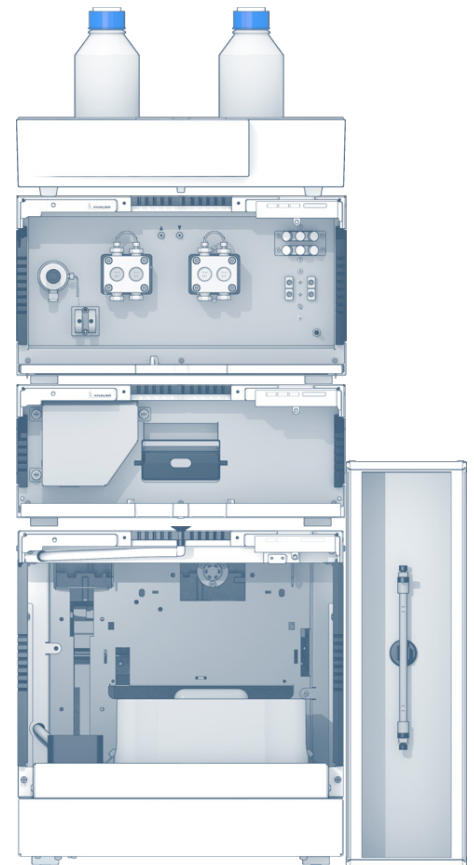

ADDITIONAL RESULTS

Tab. A1 Content of the standard solution under optimized chromatographic conditions (Fig 4)

#	Component name	Retention time	Resolution	RSD %	#	Component name	Retention time	Resolution	RSD %
1	Formaldehyde-DNPH	7.47	-	0.63	8	Methacroleine-DNPH	24.38	1.27	0.15
2	Acetaldehyde-DNPH	10.92	8.78	0.65	9	n-Bytaldehyde-DNPH	24.84	1.29	0.19
3	Acetone-DNPH	15.96	9.33	0.79	10	Benzaldehyde-DNPH	27.94	9.30	0.12
4	Acroleine-DNPH	17.63	2.69	0.47	11	Valeraldehyde-DNPH	28.85	3.00	0.38
5	Propionaldehyde-DNPH	19.26	2.81	0.53	12	m-Tolualdehyde-DNPH	30.81	6.66	0.10
6	Crotonaldehyde-DNPH	23.08	8.17	0.17	13	m-Tolualdehyde-DNPH	32.14	4.35	0.18
7	2-Butanone-DNPH	23.09	2.08	0.14					

ADDITIONAL MATERIALS AND METHODS

Tab. A2 Method parameters

Eluent A	H ₂ O _{dd}		
Eluent B	Acetonitrile		
Gradient	Time [min]	% A	% B
	0	60	40
	16	60	40
	30	40	60
	40	40	60
	41	60	40
Flow rate	1 mL/min	System pressure	-
	22 °C	Run time	45 min
Column temperature			
Injection volume	10 µL	Injection mode	-
	360 nm	Data rate	20 Hz
Detection wavelength		Time constant	0.05 s

Tab. A3 System configuration

Instrument	Description	Article No.
Pump	AZURA P 6.1L	APH35GA
Autosampler	AZURA AS 6.1L	AAA10AA
Detector	AZURA DAD 6.1L	ADC11
Flow cell	High Sensitivity LightGuide	AMD59XA
Thermostat	AZURA CT 2.1	A05852
Column	DNPH-Column, II 100-3	15CE490E2G
Software	OpenLAB CDS EZChrom Edition	A2619-1

Determination of aromatic hydrocarbon types according to DIN EN 12916:2016



Juliane Böttcher, Kate Monks; applications@knauer.net

KNAUER Wissenschaftliche Geräte GmbH, Hegauer Weg 38, 14163 Berlin; www.knauer.net

SUMMARY

In this work aromatic hydrocarbons were determined under normal phase conditions using an AZURA® analytical HPLC plus system with RI detection according to the DIN EN 12916:2016. The instrumental setup and method can be used to determine the content of hydrocarbons in motor diesel fuels, which is important for protecting the environment and public health. The standards used for system suitability according to DIN EN 12916:2016 are also part of the calibration used in the IP391(2000)/ASTM D6591 methods but the method settings are slightly divergent.

INTRODUCTION

The content of hydrocarbons in motor diesel fuels affects exhaust emissions and fuel combustion characteristics. These emissions are measured by the cetane number which is an indicator of the combustion speed of diesel fuel and compression needed for ignition [1]. It is important to measure these values due to an incomplete burning, for protecting the environment and public health. The DIN EN 12916:2016 is suitable for the determination of monoaromatic (MAH), diaromatic (DAH) and tri+ - aromatic (T+AH) hydrocarbons

in diesel fuels containing up to 30% (v/v) fatty acid methyl esters (FAME) and petroleum distillates with a boiling range of 150 °C up to 400 °C. The amount of polycyclic aromatic (Poly-AH) hydrocarbons will be calculated as the sum of diaromatic and tri+ - aromatic hydrocarbons. [2] Working according to this regulatory also requires a system suitability test to make sure that chosen HPLC hardware as well as the selected column are suitable for the application.

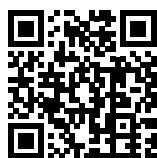

Determination of aromatic hydrocarbon types according to DIN EN 12916:2016

RESULTS

The detailed requirements and calculations for performing the system suitability are described in DIN EN 12916:2016. After achieving all necessary system specifications, a calibration was made. **Fig 1** exemplary shows the separation of system calibration standard 1 (SCS 1) containing cyclohexane, 1-phenyldodecane, o-xylene, hexamethyl benzene, naphthalene, dibenzothiophene and 9-methylanthracene. The calibration

standard consists of three different compounds: 1,2-dimethyl benzene, fluorene and phenanthrene. **Tab 1** shows the concentrations for each compound at four different levels. **Fig 2** shows the chromatogram of calibration standard A. The calculation of the number of hydrocarbons in real samples corresponds to retention times of MAH, DAH and T+AH determined in the calibration.

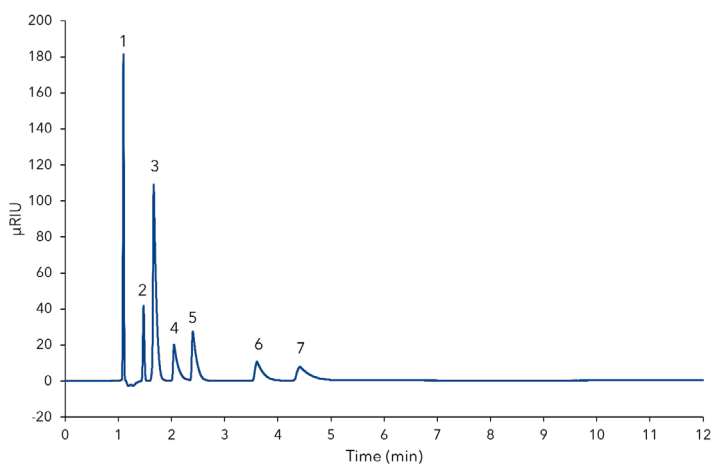

Fig. 1 System calibration standard 1 (SCS 1), 1) cyclohexane, 2) 1-phenyldodecane, 3) 1,2-dimethyl benzene, 4) hexamethyl benzene, 5) naphthalene, 6) dibenzothiophene, 7) 9-methylanthracene

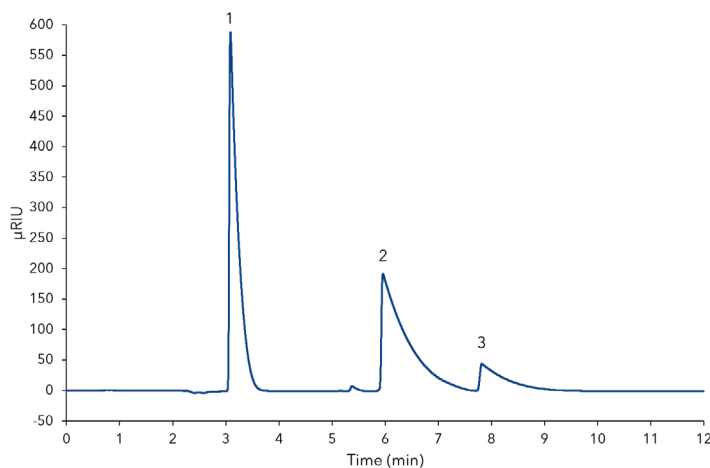

Fig. 2 Calibration standard level A, 1) 1,2-dimethyl benzene, 2) fluorene, 3) phenanthrene

Tab. 1 Calibration concentrations at four different levels

Calibration standard	1,2-Dimethylbenzene (g/100 mL)	Fluorene (g/100 mL)	Phenanthrene (g/100 mL)
A	4.00	2.00	0.40
B	2.00	1.00	0.20
C	0.25	0.25	0.05
D	0.05	0.05	0.01

MATERIALS AND METHODS

An analytical AZURA HPLC system was used for this application. It consisted of an isocratic AZURA P 6.1L pump, suitable for normal phase application. Furthermore, an AZURA RID 2.1L detector, an AZURA AS 6.1L autosampler and an AZURA CT 2.1 column thermostat. The eluent was n-heptane at a flow rate of 1.2 mL/min. The column temperature was set to 25 °C. Detector settings were set to 20 Hz with a time constant of 0.05 s. The column in a dimension 250 x 4 mm ID was filled with Nucleodur 100-5 NH₂ silica.

CONCLUSION

Using this instrumental setup, it is possible to determine mono and di-aromatic hydrocarbons according to the DIN EN 12916:2016.

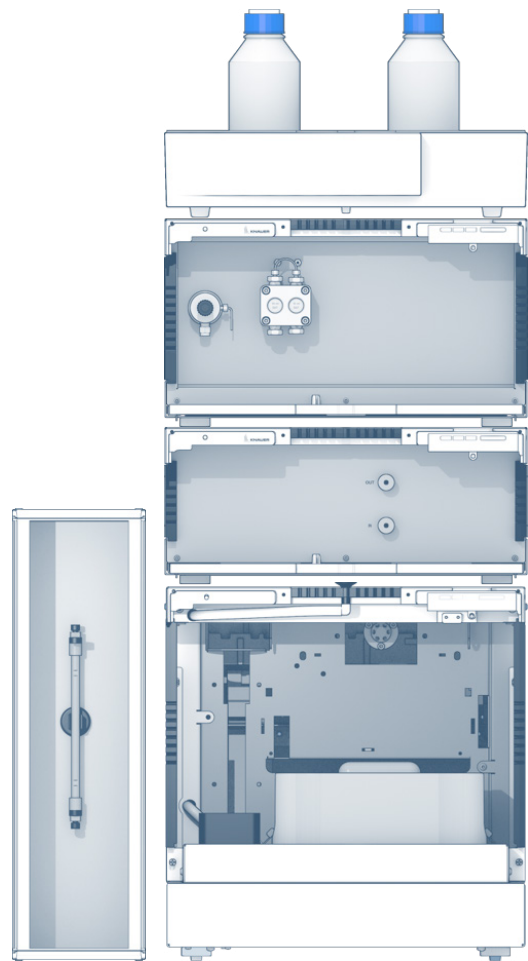

REFERENCES

[1] <http://www.astm.org/Standards/D6591.htm>

[2] DIN EN 12916:2016 Petroleum products - Determination of aromatic hydrocarbon types in middle distillates - High performance liquid chromatography method with refractive index detection, German version

ADDITIONAL MATERIALS AND METHODS

Tab. A1 Method parameters

Eluent A	n-heptane		
Gradient	isocratic		
Flow rate	1.2 mL/min		
Run temperature	25°C	Run time	30 min
Injection volume	10 µL	Injection mode	Full loop
Detection wavelength	RI	Data rate	20 Hz
		Time constant	0.05 s

Tab. A2 System configuration & data

Instrument	Description	Article No.
Pump	AZURA P6.1L, isocratic, normal phase	APH30ED
Autosampler	AZURA AS 6.1L	AAA00AA
Detector	AZURA RID 2.1L	ADD31
Column thermostat	AZURA CT 2.1	A05852
Column	Nucleodur 100-5 NH2 for normal phase, 250 x4 mm ID	25DE190NDJ
Software	ClarityChrom 7.4.2 - Workstation, autosampler control included	A1670

RELATED KNAUER APPLICATIONS

[VEV0080](#) - Determination of mono- and polyaromatic hydrocarbons in petrol with AZURA® Analytical HPLC system using RI detection

Determination of mono- and polyaromatic hydrocarbons in diesel fuels with HPLC using RI detection

Lilit Avagyan¹, Stephanie Hutfless², Kate Monks¹; applications@knauer.net

¹KNAUER Wissenschaftliche Geräte GmbH, Hegauer Weg 38, 14163 Berlin; www.knauer.net

²Haltermann Carless Deutschland GmbH, Hamburg, Germany



SUMMARY

The content of aromatic hydrocarbons in diesel fuel has an influence on exhaust emission and its combustion characteristics. Here we present the determination of aromatic hydrocarbons under normal phase conditions with an isocratic AZURA[®] Analytical HPLC system and detection via refractive index detector AZURA RID 2.1L.

INTRODUCTION

It is well known that the best performance and maximum lifetime of an engine can be reached, when the amount of aromatic hydrocarbons in diesel and aviation turbine fuels is as low as possible. Since the aromatic hydrocarbon content can affect the cetane number of fuels and cause emissions due to incomplete

burning, there are different regulations to protect the environment and public health. Below, we describe a method according to DIN EN 12916 [1] for the determination of mono- and polyaromatic hydrocarbons, like 1,2-dimethylbenzene, fluorene, and phenanthrene in diesel fuel samples.



Determination of mono- and polyaromatic hydrocarbons in diesel fuels with HPLC using RI detection

RESULTS

The chromatographical results show that all three aromatic hydrocarbons in standard solutions were successfully separated under normal phase conditions and current instrumental settings. **Fig 1** shows the overlay of chromatograms from three repetitions. The standard deviation value for retention time and peak area is 0.05% - 0.06% and 0.09% - 0.22%, respectively (**Tab 2**). The correlation factor for all compounds, obtained due analysis of three concentration levels

(standard solutions A, C, and D) is > 0.9999. The corresponding overlay chromatograms are presented in **Fig 2**. In the chromatogram of the diesel fuel sample all three compounds could be identified (**Fig 3**). The highest amount of aromatic hydrocarbons was detected for 1,2-dimethylbenzene. The calculated value is 19.26%. The values for all three hydrocarbons are presented in **Tab 3**.

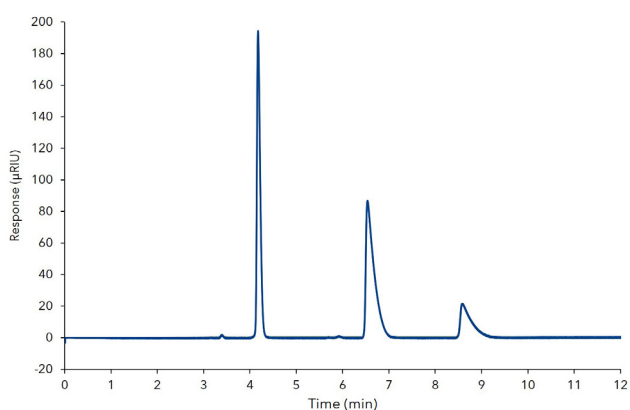

Fig. 1 Overlay chromatogram of three replicates of standard solution C

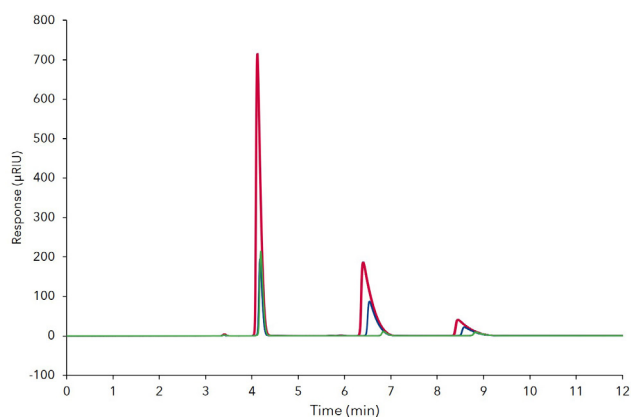

Fig. 2 Overlay chromatogram of two replicates each for standard solutions A (red), C (blue), and D (green)

Tab. 1 Amount of components in m% of standard solutions A, C, and D

Compound name	Solution A	Solution C	Solution D
1,2-Dimethylbenzene	1.515	1.348	6.557
Fluorene	0.062	0.785	2.017
Phenanthrene	0.072	0.221	0.479

Tab. 2 Reproducibility of standard solution C

Compound name	Ret. time (min)	RSD (%)	Area (µRIU-s)	RSD (%)
1,2-Dimethylbenzene	4.18	0.06	967.67	0.22
Fluorene	6.54	0.06	1067.25	0.09
Phenanthrene	8.59	0.05	355.25	0.17

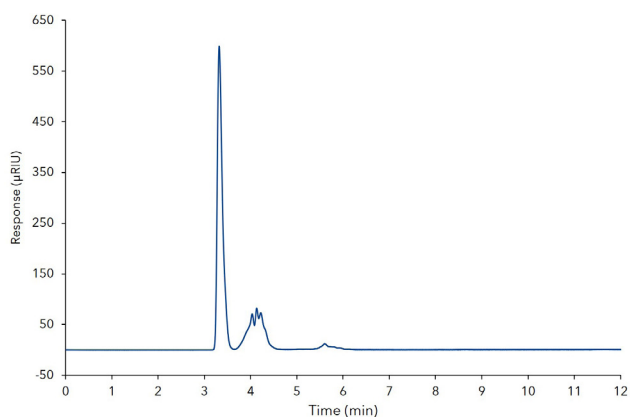

Fig.3 Chromatogram of a diesel fuel sample

Tab.3 Calculated amount of identified components in diesel fuel

Compound name	Amount (m%)
1,2-Dimethylbenzene	19.26
Fluorene	1.53
Phenanthrene	0.04

REFERENCES

[1] DIN EN 12916:2016 Petroleum products - Determination of aromatic hydrocarbon types in middle distillates - High performance liquid chromatography method with refractive index detection, German version

MATERIALS AND METHODS

For the analysis of mono-, and polyaromatic hydrocarbons we used the following HPLC system setup: isocratic AZURA P6.1L pump with 10 mL pump head, AZURA AS 6.1L autosampler, AZURA RID 2.1L detector and AZURA CT 2.1L thermostat. The separation was performed on normal phase column ZORBAX®, NH2 250 x 4.6 mm. The used mobile phase was n-heptane. For calibration three concentration levels were used. The amounts of 1,2-dimethylbenzene, fluorene and phenanthrene in corresponding solutions A, C and D are presented in **Tab 1**. The samples from the respective diesel fuel batches were diluted to 10% with n-Heptan and analyzed.

CONCLUSION

This application demonstrates, that the AZURA® isocratic analytical HPLC system in combination with AZURA RID 2.1L detector suitable for determining of mono- and polyaromatic hydrocarbons in diesel fuel according to DIN EN 12916.

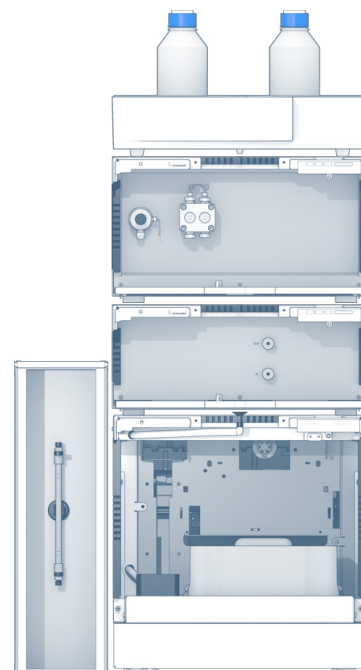

ADDITIONAL MATERIALS AND METHODS

Tab.A1 Method parameters

Eluent	n-heptane		
Gradient	isocratic		
Flow rate	1.2 mL/min	Run time	12 min
Column temperature	25 °C	Injection mode	Full loop
Injection volume	5 µL	Data rate	10 Hz
Detection	RI		

Tab.A2 System configuration

Instrument	Description	Article No.
Pump	AZURA® P6.1L	APH30ED
Autosampler	AZURA® AS 6.1L	AAA00AA
Detector	AZURA® RID 2.1L	ADD31
Column	ZORBAX®, NH2 250 x 4.6 mm	
Thermostat	AZURA® CT 2.1	A05852
Software	ClarityChrom 7.2	A1670-11

RELATED KNAUER APPLICATIONS

[VEV0078](#) - Systematic HPLC Method Development and Robustness Evaluation of 13 Carbonyl DNPH Derivatives Using DryLab®

[VEV0081](#) - GPC vs. SPE and subsequent determination of polycyclic aromatic hydrocarbons using GC/MS

GPC vs. SPE and subsequent determination of polycyclic aromatic hydrocarbons using GC/MS



Hagen Schlicke¹, Max von Delbrück¹, A.Bertin², S.Iacobellis², T.Bonato², S.Guidotti³, Kate Monks¹; applications@knauer.net
¹KNAUER Wissenschaftliche Geräte GmbH, Hegauer Weg 38, 14163 Berlin; www.knauer.net
²Laboratorio di ricerca S.E.S.A., Italy, ³Labservice Analytica S.R.L, Italy

SUMMARY

Polycyclic aromatic hydrocarbons (PAHs) are of great importance as pollutants in the environment because of their persistence, their toxicity, and their ubiquitous spread. The AZURA® GPC Cleanup system automates work-intensive and time-consuming cleanup tasks based on gel permeation chromatography (GPC). The improved reproducibility and quality of the cleanup leads to a robust application for determination of PAHs using GC/MS analysis.

INTRODUCTION

Polycyclic aromatic hydrocarbons (PAHs) are ubiquitous environmental pollutants generated primarily during the incomplete combustion of organic materials. The removal of PAHs from the atmosphere by dry and wet deposition processes are strongly influenced by their gas/particle partitioning. Atmospheric deposition is a major source for PAHs in soil [1] which can be determined by various extraction and purification processes, subsequently detected by a GC/MS using the reference method UNI EN 15527. Our main purpose is to demonstrate that the purification of

environmental matrix with high organic component using the gel permeation chromatography purification (AZURA GPC Cleanup, FS conditioned resins CHEX/DCM), compared to a SPE purification, allows are well-defined separation time of the analytes and it can provide narrow bands without their physical chemical interaction with the column, resulting in less chance of loss of analytes [2]. This differs from other separation techniques which depend upon chemical or physical interactions to separate analytes [3].

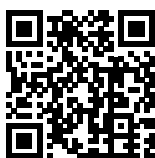

GPC vs. SPE and subsequent determination of polycyclic aromatic hydrocarbons using GC/MS

RESULTS

The comparison of analytical chromatograms obtained from GC-MS serve the evaluation of the baseline (Fig 1a). The overlays result obtained clearly confirm that the signal-to noise (S/N) and also the matrix effect of the sample is broadly reduced with

the GPC purification compared with the SPE purification (Fig 1b). The GPC purification procedure allows also an improvement for the identification of the third mass (Fig 2).

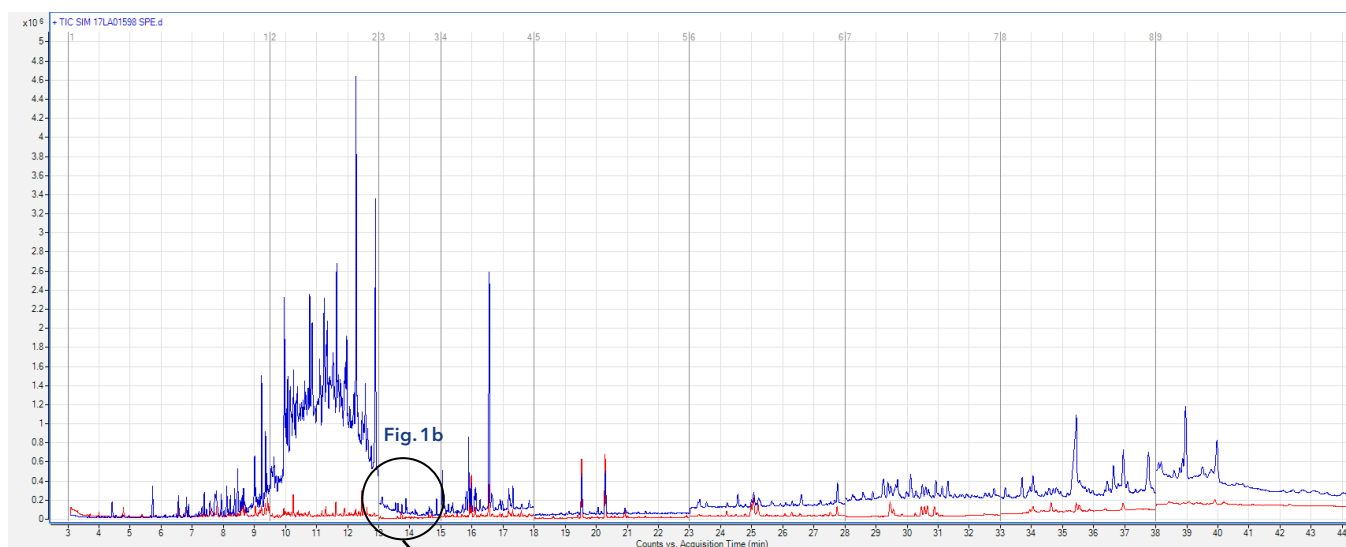

Fig. 1a Overlay of chromatograms obtained from GC-MS; blue - SPE, red - GPC

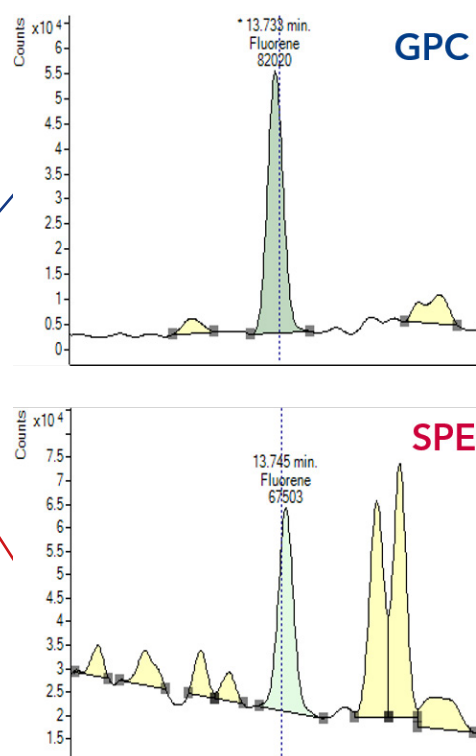

Fig. 1b Selected ion 166,1 (Fluorene)

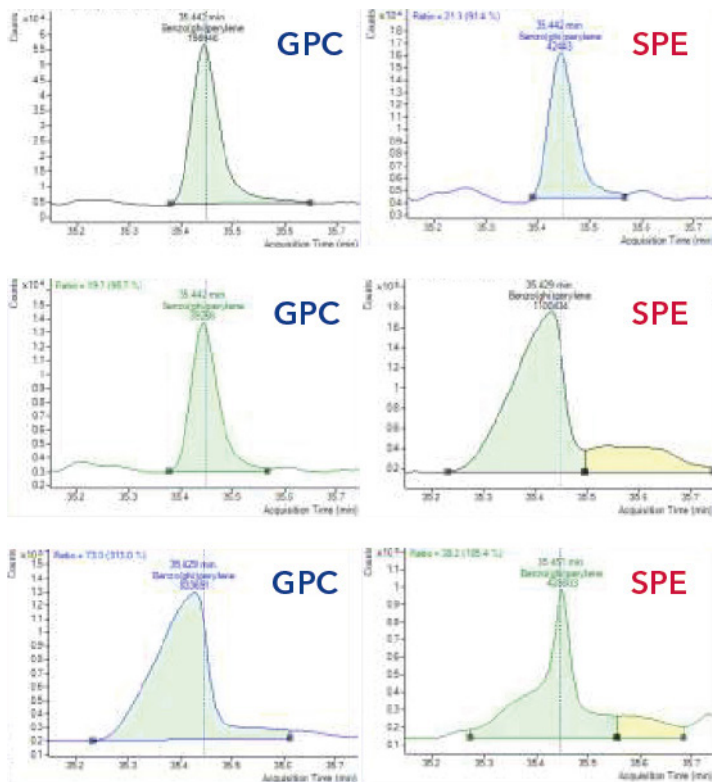

Fig.2 Identification of the third mass

MATERIALS AND METHODS

For the purification procedure a mud sludge sample (20 g) of civil waste was used. The analysis is based on UNI EN 15527: 2008 Determination of polycyclic aromatic hydrocarbons (PAH) in waste by gas chromatography with mass spectrometric detection (GC /MS). Extraction technique information: Soxhlet extraction (BUCHI B-811 system:100 extraction cycles with Acetone/Hexane - 1/1 v/v). Cleanup information: AZURA GPC Cleanup system; GPC column: 450 mm x 10 mm Phase: Biobeads SX3 - 10g; Mobile Phase: CEX/DCM - 70/30 (v/v); Flow rate: 1 mL/min Injected volume: 1 mL (concentrated sample corresponding to 4 g of sample). After Cleanup the sample volume has been reduced to 1 mL by evaporation. The extract is concentrated to minimum volume and diluted to 5 mL with GPC mobile phase. For the analysis a GC-MS single quadrupole 5975C (Agilent) was used and a volume of 1 µL was injected.

CONCLUSION

The GPC cleanup procedure of mud sludge samples prior analysis of PAHs with GC/MS technique is a good alternative to SPE purification steps. Advantages like better S/N ratios and third mass identification are obvious. The automatization of the GPC Cleanup using AZURA GPC Cleanup system yields high efficiency of the application.

REFERENCES

- [1] Hussein I. Abdel-Shafy, Mona S.M. Mansour. Egyptian Journal of Petroleum (2015)
- [2] A. Bertin, S.Iacobellis, T.Bonato, Laboratorio di ricerca S.E.S.A., S.Guidotti, Labservice Analytica S.R.L
- [3] Skoog, D.A. Principles of Instrumental Analysis, 6° ed.; Thompson Brooks/Cole: Belmont, California, 2006 , Chapter 28.

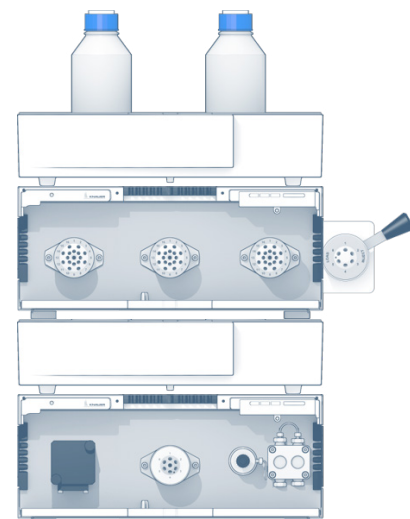

ADDITIONAL MATERIALS AND METHODS

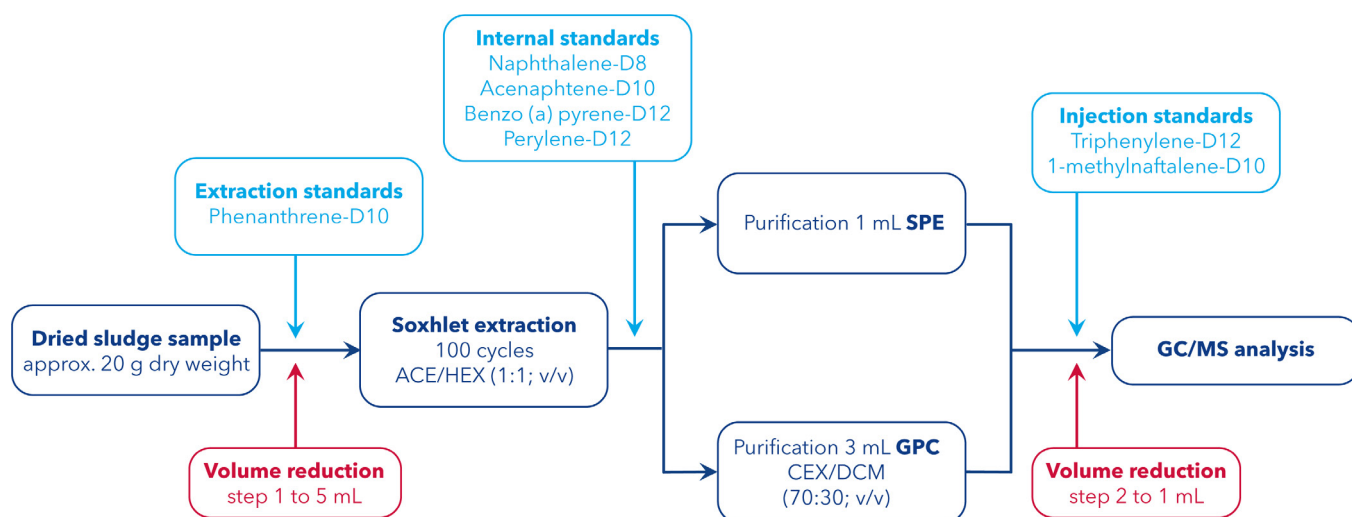

Fig. A1 Scheme of analytical method

Tab. A1 System configuration

Instrument	Description	Article No.
Pump & detector	AZURA Assistant ASM 2.1L	AYCAEABM
Loops & fractionation	AZURA Assistant ASM 2.1L	AYGAGAGA
Eluent tray	AZURA Eluent tray E 2.1L	AZC00
Tubing guide	AZURA GPC tubing guide 1 ml	A5329-2
Flow cell	Semi-preparative UV Flow Cell	A4042
Injection valve	AZURA V 2.1S valve	AVI26BC
Mounting bracket	Mounting bracket AZURA L	A9853
Software	Mobile Control Chrom with tablet	A9608



AZURA® GPC Cleanup system with Mobile Control

RELATED KNAUER APPLICATIONS

[VFD0153](#) - GPC Cleanup of olive oil samples

[VFD0146](#) - Sensitive online SPE determination of bisphenol A in water samples

[VFD0152](#) - Determination of aflatoxin M1 in milk

GPC cleanup method for soil samples before PAHs analysis

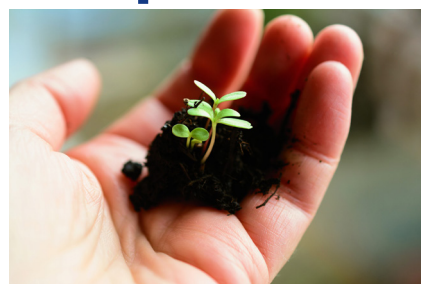

Federica Massari**, Lilit Avagyan*, Matthias Lübbert*, Kate Monks*, Pietro Cotugno**, Carlo Zambonin**, Antonella Aresta**, applications@knauer.net

*KNAUER Wissenschaftliche Geräte GmbH, Hegauer Weg 38, 14163 Berlin; www.knauer.net

** Department of Chemistry, University of Bari "Aldo Moro", Via Orabona, 4, 70126 Bari, Italy

SUMMARY

This work is focused on the development of a clean-up method with the AZURA® GPC Cleanup system to purify soil sample extracts before analysis. It was found that GPC cleanup is very useful to remove interferences from extracted soil samples before GC-MS/MS determination of semi-volatile organic compounds, like Polycyclic Aromatic Hydrocarbons. Moreover, the described method enables to perform an automated clean-up procedure and hence to purify many samples efficiently.

INTRODUCTION

GPC (Gel Permeation Chromatography) is a size-exclusion clean-up procedure that readily separates high molecular weight interferences from sample extracts using organic solvents and a porous hydrophobic gel (primarily a crosslinked divinylbenzene-styrene copolymer) [1]. It is possible to distinguish between different types of Bio-Beads resin based on the type of cross-linkage. In this application Bio-Beads S-X3 with 200–400 mesh was used according to EPA method 3640 [1]. GPC clean-up can be used extensively in numerous environmental analysis especially

for preparing sample extracts prior to semivolatile compounds determination, such as pesticide, and PAHs analysis by GC/MS or HPLC-UV-DAD. Sample cleanup is particularly important for analytical separations such as GC, HPLC, and electrophoresis because high-boiling materials can cause a variety of problems in analytical systems, like analyte adsorption in the injection port or in front of a GC or LC column [2]. GPC cleanup protects GC and HPLC columns, reduces analytical maintenance costs, improves accuracy, and allows lower detection limits.



GPC cleanup method for soil samples before PAHs analysis

RESULTS

The calibration of the AZURA® GPC Cleanup System was performed with a calibration mixture in dichloromethane containing the following compounds also reported in EPA method 3640: corn oil, methoxychlor; phthalic acid, bis-2-ethylhexyl ester (ester of phthalic acid), perylene, and sulfur [1]. 1 mL calibration standard was diluted with 2 mL dichloromethane and 7 mL cyclohexane to resemble the mixture similar to the mobile phase for GPC. 2 mL solution were injected and calibration test was carried out for 60 min at a flow rate of 1 mL/min.

In **Fig. 1** the chromatogram of diluted calibration mixture solution is reported. According to 3640 EPA method, a reagent blank should be analyzed for the compounds of interest prior to the use of the clean-up method [1]. The level of interferences must be below the estimated quantitation limits of the analytes before the method is performed on samples. Using the information coming from the detector, it could be possible to establish appropriate collect time periods for target analytes. 3640 EPA method suggests to initiate column collection just before elution of bis-(2-ethylhexyl) phthalate, after the elution of the corn oil and to stop eluate collection shortly after the elution of perylene, in order to ensure semi-volatiles

collection [1]. In particular, a recovery test was performed using PAH standard solution and it was observed that the proper collection time ranged from 18 to 45 min to ensure a good recovery efficiency for the analytes of interest. GPC cleanup method was successfully applied to different soil samples' extracts derived from the Environmental Chemistry Laboratory of the Department of Biology, University of Bari (separate branch of Taranto, Italy). After performing clean-up method on the selected samples, they were concentrated under nitrogen stream and ready to perform analytical determination.

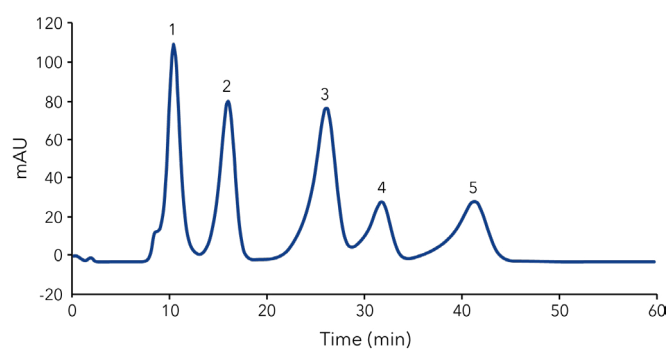

Fig. 1 Chromatogram of a diluted calibration mixture solution 1) Corn oil (5 mg/mL), 2) Phthalic acid, bis-2-ethylhexyl ester (1 g/L), 3) Methoxychlor (0.2 g/L), 4) Perylene (0.02 g/L), 5) Sulfur (0.08 g/L)

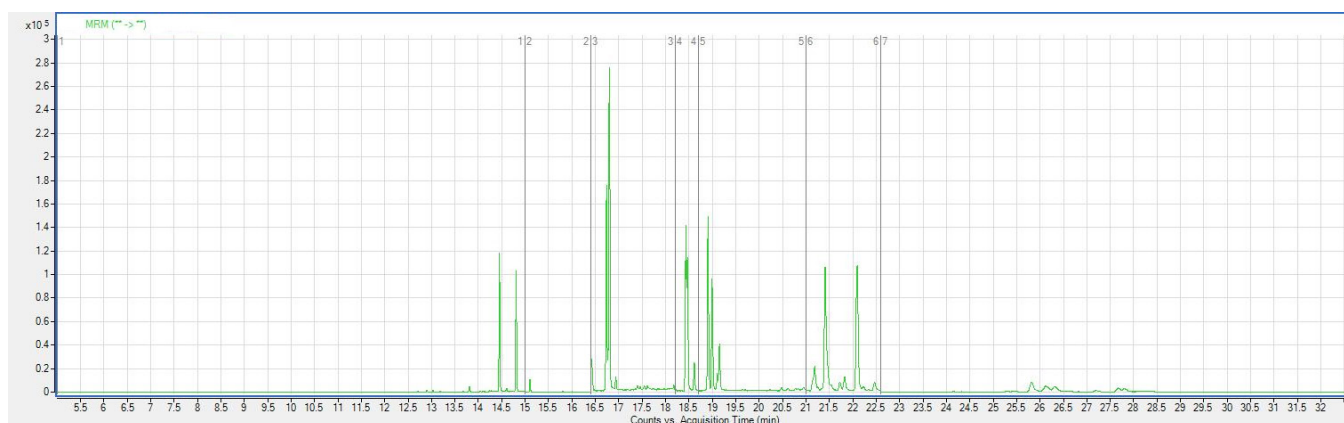

Fig. 2 GC-MS/MS chromatogram of purified soil sample: determination of PAHs

MATERIALS AND METHOD

Extraction of Polycyclic Aromatic Hydrocarbons was carried out using Accelerated Solvent Extraction (ASE), according to the 3545A EPA method [3]. Bio-Beads S-X are supplied dry and must be swollen prior to pack into a chromatographic column. A mixture of cyclohexane and dichloromethane (70:30, v:v) is suitable for clean-up of soil samples. As a general rule, the beads should be swollen in the same solvent chosen as mobile phase, so 10 g of Bio-Beads S-X3 were swelled with 50 mL of cyclohexane and dichloromethane mixture (70:30, v:v) overnight. After the beads were fully swollen, they were packed into a chromatographic column. Before sample cleanup, GPC column was

equilibrated with the desired solvent mixture, flushing it almost three times the column volume at 1 mL/min. Cleanup method was performed with AZURA® GPC Cleanup System, which is operated with the Mobile Control Chrom® Software running on a tablet directly mounted on the system. The identification and quantification of PAHs was carried out by GC-MS/MS analysis. Calibration curves were constructed in the concentration range from 10 µg/L to 130 µg/L. To perform GC separation and MRM acquisition, optimization of the best chromatographic and detection conditions was necessary.

CONCLUSION

This application shows how to perform GPC cleanup with KNAUER AZURA® GPC Cleanup System for the analysis of PAHs in soil samples. This report is very detailed to ensure good performance in GPC cleanup for application in environmental area. We can conclude that AZURA GPC Cleanup System is a helpful tool for sample preparation before instrumental analysis because, unlike other techniques, is very useful for the removal of high boiling materials which would contaminate injection ports and column heads, prolonging column life, stabilizing the instrument, and reducing column reactivity. It could be considered an universal cleanup technique for a broad range of semivolatile organics and pesticides. Moreover, AZURA GPC Cleanup System allows the customer to process many extracted samples, with a reduction in time for the cleanup procedures.

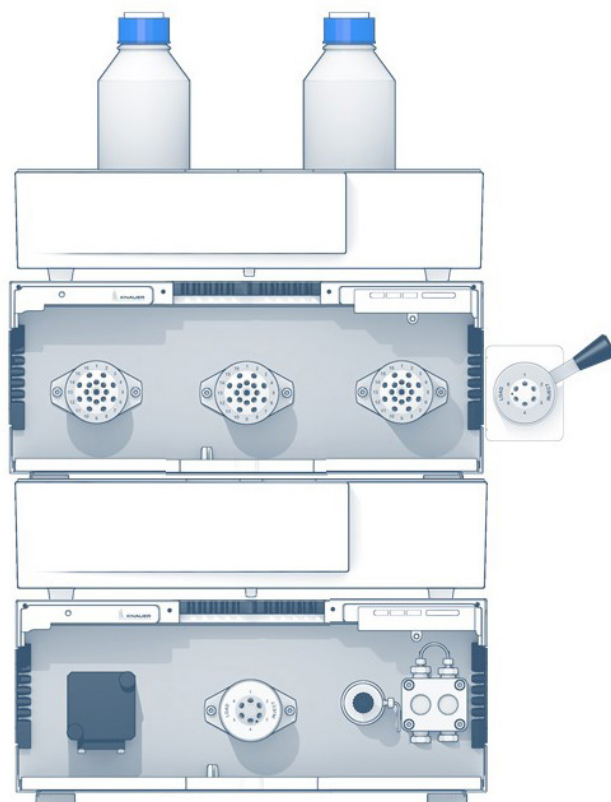

REFERENCES

- [4] EPA Method 3640A: Gel-Permeation Cleanup
- [5] J. D. Winefordner. Chemical analysis: a series of monographs on analytical chemistry and its applications. Vol. 162, p.21 -25
- [6] EPA Method 3545A: Pressurized Fluid Extraction (PFE)

ADDITIONAL MATERIALS AND METHODS

Tab.A1 ASE Method parameters

Temperature	100°C
Pressure	1500 psi
Static time	5 min
Cycles	1
Purge	60 s
Solvent	Hexane/DCM (1:1, v:v)
Cell volume	34 mL

Tab.A2 GPC Method parameters

Eluent A	Cyclohexane/Dichloromethane (70:30, v/v)		
Gradient	isocratic 100 % A		
Flow rate	1 mL/min	System pressure	35 psi
Column temperature	RT	Run time	60 min
Injection volume	2 mL	Injection mode	Full loop
Detection wavelength	254 nm	Data rate	10 Hz
Collect time	18-43 min	Time constant	0.1 sec

Tab.A3 System configuration (GPC Cleanup system)

Instrument	Description	Article no.
Injection valve	Manual injection valve 6-port 2-position	AVI26BC
Assistant 1	AZURA ASM 2.1 L left: single variable wavelength UV detector middle: 6 port column bypass valve right: pump with pressure sensor, 10 mL pump head in SST	AYCAEABM
Assistant 2	AZURA ASM 2.1 L left: 16 port multi position valve for fractioning middle: 16 port multi position valve for sample loop right: 16 port multi position valve for sample loop	AYGAGAGA
Flow cell	UV, 3 mm, 2 µL	A4042
GPC tubing guide	16 sample loops with 1 mL	A5329-2
Column	450 mm length, 10 mm ID Resin Bio Beads SX-3	
Software	Mobile control	A9608

Tab.A4 GC-MS/MS method

Injector	Split/Splitless	
Mode	Splitless	
Injector temperature	280°C	
Injection volume	2 µL	
Flow rate	1 mL/min	
Carrier gas	Helium	
Capillary column	HP-5MS 30 m x 250 µm x 0.25 µm	
Oven temperature program	80° for 3 minutes from 80 to 300°C at 15°C/min 15 min at 300°C	
Transfer line temperature	300°C	
Electron impact mode	Positive ion	
Solvent delay	5 minutes	
Source temperature	280°C	
Quadrupole Temperature	150°C	
Scan type	MRM, multiple reaction monitoring	
QQQ Collision cell	Quench gas flow rate	2.25 mL/min
	Collision gas flow rate	1.5 mL/min

RELATED KNAUER APPLICATIONS

[VFD0153](#) - GPC Cleanup of olive oil samples

[VEV0081](#) - GPC vs. SPE and subsequent determination of polycyclic aromatic hydrocarbons using GC/MS

[VFD0166](#) - LC-FLD analysis of 4 PAHs in olive oil samples using AZURA® GPC Clean-up System

Sensitive and selective analysis of wood sugars and uronic acids for biofuel research with electrochemical detection

Kristin Folmert, Jan Wendrich, Kate Monks; applications@knauer.net
KNAUER Wissenschaftliche Geräte GmbH, Hegauer Weg 38, 14163 Berlin;
www.knauer.net



SUMMARY

Monosaccharides belong to the most abundant group of biomolecules in nature. They play a crucial role in metabolism, structural biology, and storage of energy. Thus, the analysis of these special type of carbohydrates is of great interest for the food industry but also for a broad range of life and material sciences. The presence of hydroxyl groups enables a specific and highly sensitive analysis using pulsed amperometric detection (PAD) with the DECADE Elite electrochemical detector as part of the dedicated AZURA® High Performance Anion Exchange Chromatography (HPAEC) system.

INTRODUCTION

The sources for the different kinds of monosaccharides can vary between food samples like honey [1] or fruits, to scientific applications like glycopeptides or they can be products of fermentation processes like the here analysed wood monosaccharides. The mixture of the seven hemicellulosic sugars fucose, rhamnose, arabinose, galactose, glucose, xylose and mannose mixed with the two uronic acids galacturonic acid and glucuronic acid, extracted from wood by heat or chemical pretreatment, are of special interest in the research for new biofuels. They are considered

to be more sustainable and are expected to become a competitive commercial alternative to fuel made from corn and other food sources [2]. Carbohydrates are weak acids with pKa values between 12 and 14. Consequently, they can be completely or partially ionized under basic conditions with pH >12. Due to these harsh conditions, only polymeric anion exchange columns are suitable for the monosaccharide analysis. The retention time with AZURA HPAEC is inversely correlated with pKa value and increases significantly with molecular weight of the monosaccharide.



Sensitive and selective analysis of wood sugars and uronic acids for biofuel research with electrochemical detection

RESULTS

Using an analyte concentration of 0.1 mg/mL for the standard mixture of the nine wood monosaccharides and acids, all components could be baseline-separated ($R_s > 1.5$) (Fig 1). The separation of the analyte peaks increases with decreasing sample concentration. The two monosaccharides xylose (6) and mannose (7) could not be baseline-separated with concentrations higher than 0.1 mg/mL. The signal to noise (S/N) ratio for each analyte was calculated from empiric data (Tab 1). Noise values were determined for this concentration from two different baseline areas. For the monosaccharide sugars 1-7 the averaged noise was determined with 0.001 μA and for the uronic acids 8-9 a value of 0.1 μA was determined. Concentration curves of all analytes from 0.0125 to 0.25 mg/mL are depicted in Fig 2.

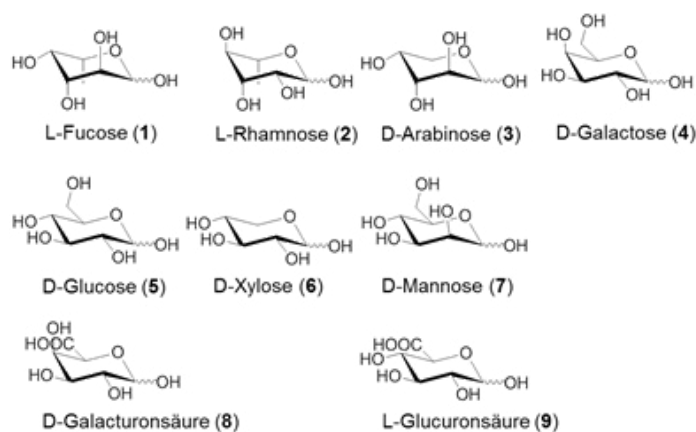

Pyranose structure of the seven wood monosaccharides and the two uronic acids

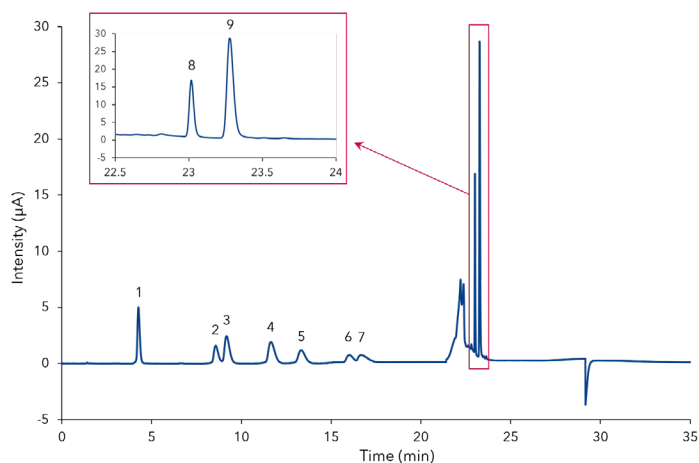

Fig. 1 Chromatogram of a standard mixture containing 0.1 mg/mL fucose (1), rhamnose (2), arabinose (3), galactose (4), glucose (5), xylose (6), mannose (7), galacturonic acid (8) and glucuronic acid (9). And a zoom into the peaks for the uronic acids

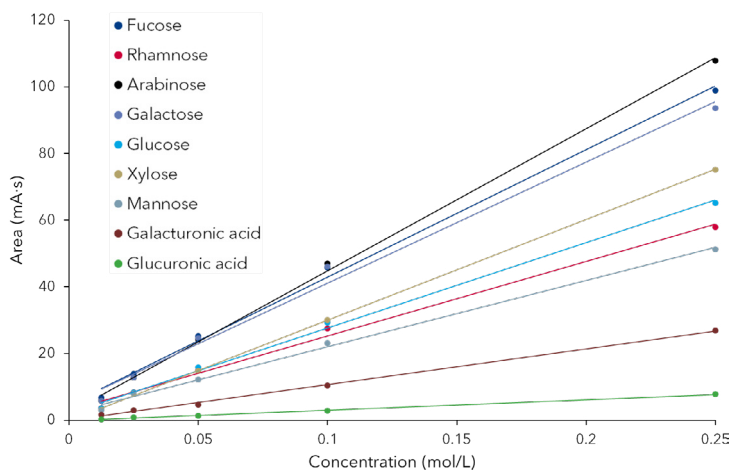

Fig. 2 Concentration curves of the described sugars and uronic acids in a concentration range between 0.0125 mg/mL to 0.25 mg/mL

Analyte	S/N
L-fucose	10000
L-rhamnose	3000
L-arabinose	4800
D-galactose	3800
D-glucose	2400
D-xylose	1600
D-mannose	1600
D-galacturonic acid	338
D-glucuronic acid	574

Tab. 1 Empiric determined S/N ratios for a 10 μL injection

MATERIALS AND METHODS

An AZURA glass- and metal-free High Performance Anion Exchange Chromatography (HPAEC) system was used. It was comprised of an AZURA P 6.1L LPG pump, an AZURA AS 6.1L autosampler and a DECADE Elite electrochemical detector which was also used for column tempering. The analysis was based on a step-gradient with different concentrations of NaOH solution (**Tab A2 & A3**, additional material). While working with low concentrations of NaOH, carbonate ions, present in the mobile phase, can bind to the column material and thereby decrease separation efficiency. Hence, a column regeneration with higher concentrations of NaOH is recommendable for each run. Furthermore, during eluent preparation the contamination with carbonate ions should be minimized by using carbonate-free 50 % w/w NaOH solution (commercially available) and an ultrasonic degassing step before the introduction into the system. Eluents should be completely refreshed daily. With respect to the high sensitivity of the DECADE Elite detector and the etching property of the NaOH, only plastic eluent bottles, plastic eluent filters and metal-free system compartments should be used to prevent the detection of unexpected ions, silicates or borates. For detection an Antec electrochemical SenCell with Au working electrode, HyREF (Pd/H₂) reference electrode and stainless steel auxiliary electrode was used with a 4-step potential waveform (**Fig A1**, additional material).

REFERENCES

- [1] H. Schlicke, K. Monks, KNAUER AppNote VFD0161, 2017
- [2] M. J. González-Muñoz, R. Alvarez, V. Santos, J. C. Parajó, Wood Science and Technology, 2012, 46, 1-3, 271-285.

CONCLUSION

High Performance Anion Exchange Chromatography (HPAEC) with pulsed amperometric detection (PAD) using the AZURA HPAEC-PAD dedicated system and applying the developed method is a highly sensitive setup for the analysis of sugar monosaccharides and other carbohydrates. The mixture of seven monosaccharides and two uronic acids could be baseline-separated with very high S/N ratios. An easy to perform method using different concentrations of NaOH allows a fast and reproducible analysis even in low concentrations. Besides the research for biofuels, the investigated sugars are components in numerous processes in nature and food applications. Thus, the current application is suitable for several issues where carbohydrates need to be specifically separated and analyzed.

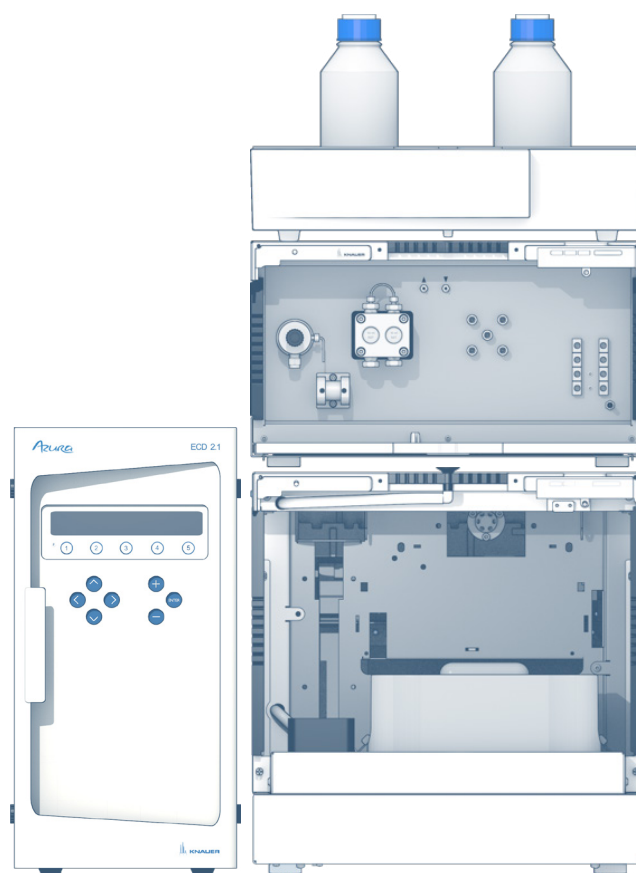

ADDITIONAL MATERIALS AND METHODS

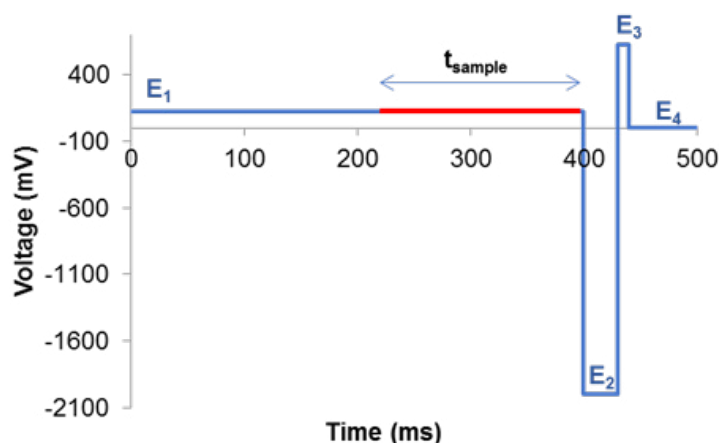

Fig. A1 4-step PAD potential waveform for the detection of mono-saccharides and other carbohydrates. The sample detection occurs during the highlighted time period t_{sample} .

Tab. A1 Method parameters

Eluent A	Water		
Eluent B	200 mM NaOH		
Eluent C	700 mM NaOH		
Flow rate	0.4 mL/min	Pressure	220 bar
Run temperature	40°C	Run time	35 min
Injection volume	10 μ L	Injection mode	Full loop
Detection wavelength	ECD (40°C)	Data rate	2 Hz
		Time constant	0.2 sec

Tab. A3 System configuration

Instrument	Description	Article No.
Pump	AZURA® P6.1L, LPG 10 mL bio inert	APH39EA
Autosampler	Autosampler AS 6.1L bio inert	AAA20AA
Detector	Electrochemical Detector DECADE Elite SCC with SenCell Au HyREF	A07545 A07546-3
Column	Dionex™ CarboPac™PA20 250x4mm	B08154-1
Precolumn	CarboPac™PA20 30x3mm	B081517
Software	ClarityChrom 7.4.2	A1670

Tab. A2 Gradient method description

Time (min)	A (%)	B (%)	C (%)	Flow (mL/min)
0.00	100	0	0	0.4
11.00	100	0	0	0.4
11.02	98.8	1.2	0	0.4
19.98	98.8	1.2	0	0.4
20.00	30	0	70	0.4
25.00	30	0	70	0.4
25.50	100	0	0	0.4
35.00	100	0	0	0.4

RELATED KNAUER APPLICATIONS

[VFD0062J](#) - Fat soluble Vitamins by HPLC with electrochemical detection

[VFD0161](#) - Determination of sugars in honey using HILIC separation and RI detection

Sensitive online SPE determination of bisphenol A in water samples

Juliane Böttcher, Kate Monks; applications@knauer.net

KNAUER Wissenschaftliche Geräte GmbH, Hegauer Weg 38, 14163 Berlin; www.knauer.net



SUMMARY

In this application a method for the sensitive determination of bisphenol A (BPA) from water samples is presented. The use of online solid phase extraction (SPE) coupling avoids time consuming and manual sample preparation steps, making the method well-suited for routine analyses of BPA in low concentration samples like drinking water.

INTRODUCTION

Solid phase extraction is an effective preparation method for concentrating analytes prior to HPLC analysis. Classically, this method is done offline via time consuming steps. The advantages of online coupling result in a reduction of analysis time, sample contamination and analyte loss. This automated method is perfectly suited for pre-concentration of BPA in drinking water. The main source for BPA is the industrial production of polycarbonates and polyvinyl

chloride (PVC) where it is a major constituent. It is also an important monomer in the production of polycarbonate. BPA is known for its endocrine effects similar to the hormone estrogen even at very low dosage and is associated with environmental and health problems. Based on previous studies a maximum entry $<1 \mu\text{g/mL}$ in cold drinking water is expected. In warmed-up water (70°C) a concentration up to $30 \mu\text{g/mL}$ is possible.



Sensitive online SPE determination of bisphenol A in water samples

RESULTS

After calibration by direct injection using an auto-sampler, the recovery rate is determined with the online SPE column in the flow path. Differing concentrations down to 0.07 ng/mL have been extracted from prepared water samples with constant extraction time. **Fig 1** shows the chromatogram of three different

concentrations with same online SPE extraction time. **Fig 2** shows an original drinking water sample spiked with BPA. Afterwards the extraction time was varied using a solution with a constant concentration of 0.1 ng/mL. A recovery rate of 98 % for BPA was found.

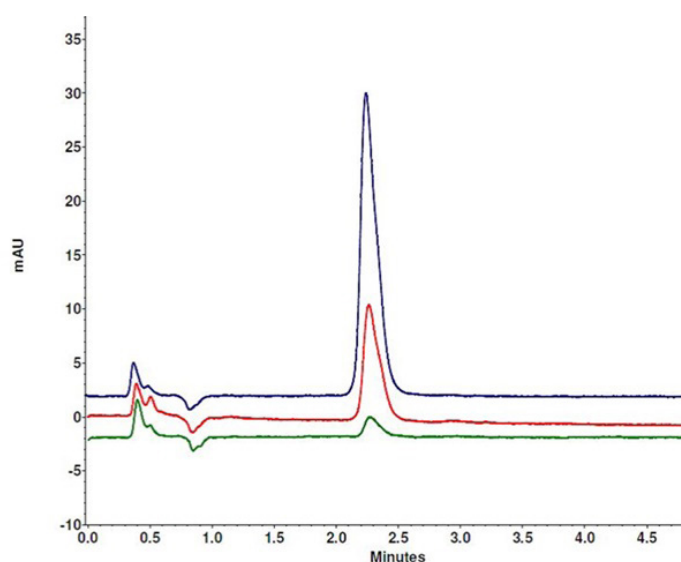

Fig. 1 To determine the recovery rate of calibration points, two different methods are taken as a basis. First three differing concentration ($c_1=0.07$ ng/mL, $c_2=0.4$ ng/mL, $c_3=1$ ng/mL) have been extracted with the same extraction time. In this part recovery rates of 93 % for bisphenol A were found ($n=4$ for each concentration).

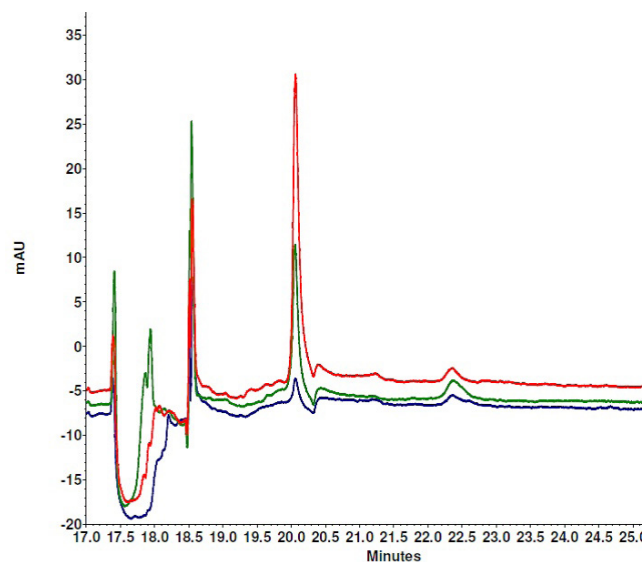

Fig. 2 Chromatogram of three different concentrations with same online SPE extraction time.

MATERIALS AND METHODS

An AZURA® Analytical HPLC Plus system was used for this application. It consists of an AZURA P 6.1L LPG pump, an autosampler 3950, an AZURA CT 2.1 column thermostat, a AZURA MWD 2.1L multi wavelength detector and an assistant AZURA ASM 2.1L equipped with a 12 port multi position valve, a 6 port/2 position injection valve and a pump with 10 mL pump head. The analytical method runs isocratic at a flow rate of 0.6 mL/min with a mixture of acetonitrile and water 50:50 (v/v). The column thermostat was set to 30 °C and the detector recorded at 227 nm.

The used columns are filled with KNAUER Eurospher II 100-3 C18A silica. The SPE method parameters are divided into different steps, including column conditioning, sample extraction, sample analysis, and reconditioning of the SPE column.

CONCLUSION

The method presented in this application note is well suited for the analysis of bisphenol A in water samples like drinking water and allows varying the extraction time dependent on the expected bisphenol A concentration. For a higher and better evaluable peak signal the time the sample flushes over the extraction cartridge can simply be increased. With this sensitive method it is possible to successfully quantify even low concentrated samples and extracts and equipped with the AZURA ASM 2.1L the system can easily be used in continuous operation.

REFERENCES

- [1] Ligang Chen, Hui Wang, Qinglei Zeng, Yang Xu, Lei Sun, Haoyan Xu, Lan ding, "Online Coupling of Solid-Phase Extraction to Liquid Chromatography—A Review", Journal of Chromatographic Science, Vol. 47, September 2009
- [2] Jordáková I., Dobiás J., Voldrich M., Poustka J. Determination of Bisphenol A, Bisphenol F, Bisphenol A diglycidyl Ether and Bisphenol F Diglycidyl Ether migrated from food cans using Gas Chromatography- Mass spectrometry. Czech J. Food Sci. 2003 Vol. 21, No. 3: 85-90
- [3] Umweltbundesamt, Abteilung Umwelthygiene. Telegramm: Umwelt + Gesundheit. „Bisphenol A“ - Wir haben ein Problem. Ausgabe 04/2008
- [4] Umweltbundesamt, Pressestelle „Bisphenol A Massenkemikalie mit unerwünschten Nebenwirkungen“, aktualisierte Fassung Juli 2010, http://www.umweltbundesamt.de/uba-infomedien/mysql_medien.php?anfrage=Kennnummer&Suchwort=3782



ADDITIONAL RESULTS

Tab. A1 SPE Parameters

Step 1 (sample extraction)	Flush the extraction column with 100 % water for 0.5 min at a flow rate of 3 mL/min
Step 2	Switch to the sample and extract it for 15 min (variable) with a flow rate of 3 mL/min
Step 3	Flush again with 100 % water for 1.5 min at a flow rate of 3 mL/min
Step 4 (sample analysis)	Switch the extraction column into the determination part of the HPLC system for 3 min, starting the data acquisition immediately after switching
Step 5 (extraction column cleaning)	After switching back, flush with 100 % acetonitrile for 3 min at a flow rate of 3 mL/min
Step 6	Flush with water at a flow rate of 3 mL/min for 5 min and then at a flow rate of 0.5 mL/min until the end of method

ADDITIONAL MATERIALS AND METHODS

Tab. A2 Method parameters

Analytical

Eluent A	Water		
Eluent B	Acetonitrile		
Gradient	Isocratic 50 % B		
Flow rate	0.6 mL/min	System pressure approx. 230 bar	
Column temperature	30 °C	Run time	5 min
Injection volume	10 µL	Injection mode	Full loop
Detection wavelength	227 nm	Data rate	20 Hz
		Time constant	0.05 s

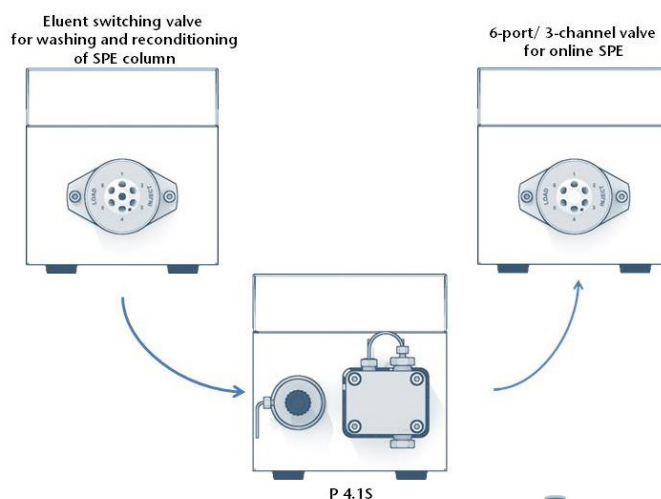

Tab. A3 System configuration & data

Instrument	Description	Article No.
Pump	AZURA P 6.1L, LPG 10ml, SSt	APH34EA
Autosampler	Autosampler 3950	A50070
Detector	AZURA MWD 2.1L	ADB01
Flow Cell	LightGuide 50mm, 6µL	AMD59
Assistant	AZURA ASM 2.1L, left: 12 port multi position valve, 1/8" connectors middle: 6 port 2 position injection valve, 1/16" connectors right: pump with pressure sensor, 10 mL pump head, SSt	AYFAEABA
Thermostat	AZURA CT 2.1 Column Thermostat	A05852
Eluent tray	AZURA ET 2.1L	AZC00
Column	Vertex Plus Column, 100x3 mm ID, Eurospher II 100-3 C18A	10CE184E2G
Column SPE	Vertex Plus Column, 30x4 mm ID, Eurospher II 100-3 C18A	03DE184E2G
Software	OpenLAB CDS EZChrom Edition	A2600-1



Dedicated AZURA® Online SPE System

Alternative xylitol extraction via hplc purification from fermented biomass

Yannick Krauke, Hagen Schlicke, Matthias Luebbert, Kate Monks; applications@knauer.net
KNAUER Wissenschaftliche Geräte GmbH, Hegauer Weg 38, 14163 Berlin; www.knauer.net



SUMMARY

A latest approach in bioethanol generation is the usage of yeast and bacteria that uses C5 sugars for fermentation and the valorization of bio refinery by products. Here it is shown that a hemicellulose-like fermentation mash has a high content of the artificial sweetener xylitol and that its purification by HPLC can be accomplished using polymer based Eurokat columns. The product is soluble in water and can easily be used for further applications.

INTRODUCTION

The second generation of bio refinery uses biomass with lower contents of C6 glucose and higher contents of C5 sugars. Besides ethanol generation its goal is the full usage of biomass by valorizing by products. Fermentation of C5 sugars with microorganisms result in mash that could be used for further applications.

Polymer based Eurokat columns were tested for their ability to separate fermentation mash and among them the Eurokat Ca column had the best separation profile. Analysis of the mash revealed high contents of xylitol. Purification of highly pure xylitol was established.

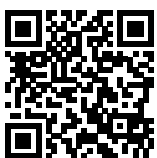

Alternative xylitol extraction via hplc purification from fermented biomass

RESULTS

The fermentation mash was analyzed on different columns (Eurokat Na, H, and Ca) to determine the optimal stationary phase. The Eurokat Ca column showed the best separation profile for xylitol **Fig.1** even though it has the longest run with about 28 min compared to Eurokat Na with 18 min and Eurokat H with 12 min (not shown). A more detailed analysis of the fermentation mash identified five components: xylose, arabinose, glycerol, mannitol and xylitol **Fig.1**. Xylitol had the highest concentration with 80 mg/mL in the sample, followed by glycerol with 20 mg/mL.

The other three components had concentrations of 7-8 mg/mL **Fig.1**. The baseline separation of xylitol indicated promising batch purification. Overload studies with a semi-preparative Eurokat Ca column were performed. This column has a three times higher volume (50 mL) than the analytical column (15 mL) and larger particle size (25-56 μm) enabling higher sample loading and faster flow rates with lower back pressure. The collected fraction of xylitol **Fig.2** had a purity of 99 %, measured with RI **Fig.3**.

Sample analysis

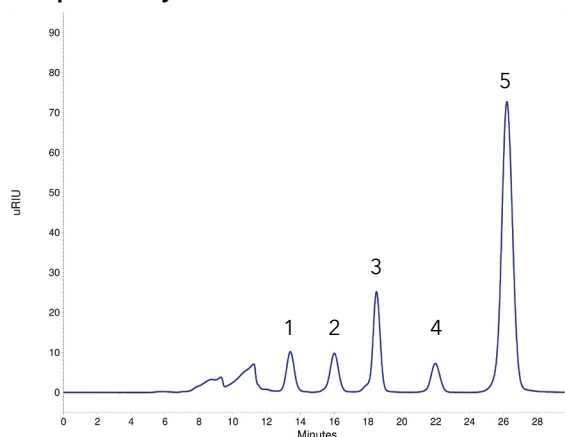

Fig. 1 Chromatogram of 1:10 dilution of fermentation mash 10 μL injection on Eurokat Ca; 1) xylose (8.2 mg/mL), 2) arabinose (8.3 mg/mL), 3) glycerol (21.0 mg/mL), 4) mannitol (7.0 mg/mL), 5) xylitol (80.6 mg/mL)

Batch purification

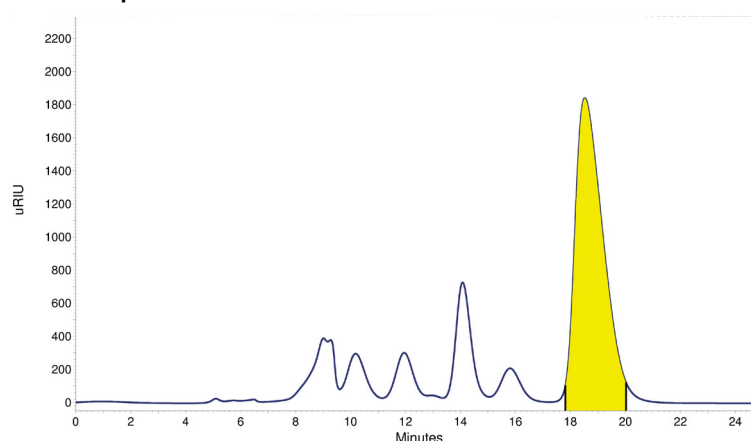

Fig. 2 Fractionation of xylitol from 1000 μL injection; yellow fraction area (9.5 mL)

Fraction analysis

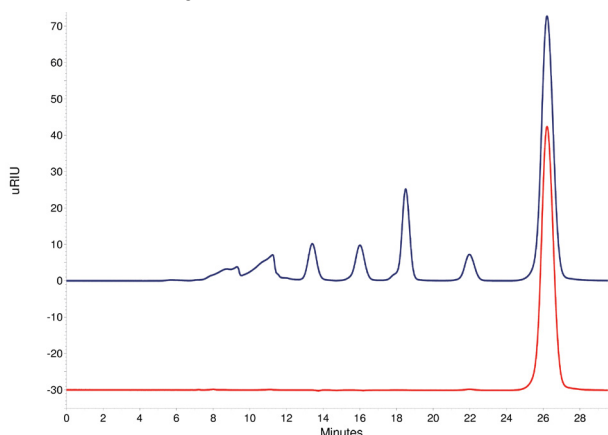

Fig. 3 Comparison of sample and fraction chromatograms; blue - sample, red - fraction from batch purification

Acknowledgement: This project has received funding from the European Union's Seventh Framework Program for research, technological development and demonstration under grant agreement no FP7-KBBE-2013-7-613802.



MATERIALS AND METHOD

Vogelbusch Biocommodities GmbH provided the fermentation mash that resulted from fermentation with yeasts of hemicellulose-like hydrolysate with high xylose content. The sample was filtered through 0.45 μm filter after centrifugation. A 1:10 dilution was prepared and analyzed. For calibration a mixture of xylose, arabinose, glycerol, mannitol and xylitol was prepared and six dilution steps from 15 mg/mL to 0.3 mg/mL prepared. Analytical runs were performed with KNAUER analytical Eurokat columns (300 \times 8 mm) with integrated pre-columns (30 \times 8 mm) with 10 μm particles at 75 $^{\circ}\text{C}$ running at flow rates of 0.5 mL/min using H₂O as eluent. The KNAUER AZURA analytical HPLC system comprising of the AZURA P 6.1L HPG 10 mL pump, 3950 autosampler, AZURA DAD 2.1L diode array detector with high

sensitivity KNAUER LightGuide cartridge flow cell, AZURA RID 2.1L refractive index detector, AZURA CT 2.1 column thermostat controlled by the OpenLAB[®] EZChrom Edition software was used. The purification of xylitol was performed with KNAUER Eurokat Ca columns (250 \times 16 mm) with 25–56 μm particles at 75 $^{\circ}\text{C}$ running at flow rates of 2.5 mL/min using H₂O as eluent. The KNAUER AZURA Preparative HPLC system comprising of the AZURA P 6.1L HPG 50 mL pump, 3950 autosampler (preparative version), AZURA RID 2.1L refractive index detector, AZURA CT 2.1 column thermostat controlled by the OpenLAB[®] EZChrom Edition software was used. The refractive index detector's Extended Dynamic Range (EDR) feature was used for preparative experiments.

CONCLUSION

The Eurokat Ca column was found to be the best column for analysis of fermentation mash among tested Eurokat columns. The used fermentation mash has a high content of xylitol (80 mg/mL). A semi-preparative batch purification of the xylitol resulted in high recovery (95 %) of xylitol with a purity of 99 %. Upscaling of the batch process or application of SMB (simulated moving bed) chromatography would be promising for xylitol production from fermentation mash.

AZURA Analytical system

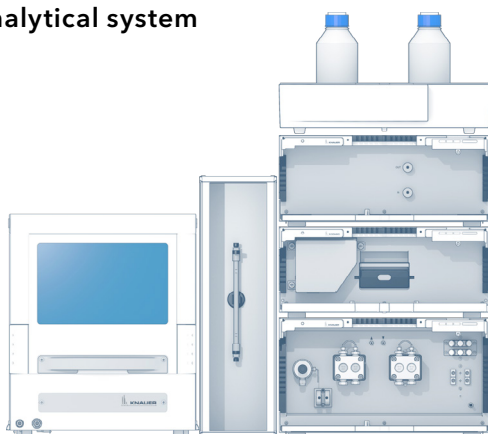

AZURA Preparative system

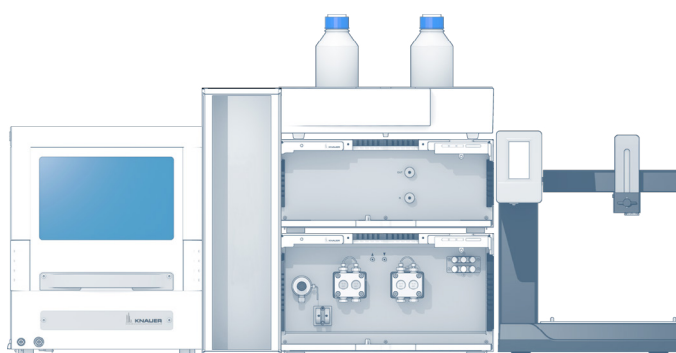

ADDITIONAL RESULTS

The fermentation mash was separated on Eurokat Na and Eurokat H columns **Fig A1**. On the Eurokat Na column only three peaks were detected. The the Eurokat H column xylitol was also not baseline separated from the other substances. For the overload studies 50 μL to 1500 μL of the 1:10 dilution of the fermentation mash were separated on the Eurokat Ca column. Overlays of all the chromatograms show a shift in the early eluting phase (10-14 min) due to volume overload but less for xylitol **Fig A2**.

Column screening

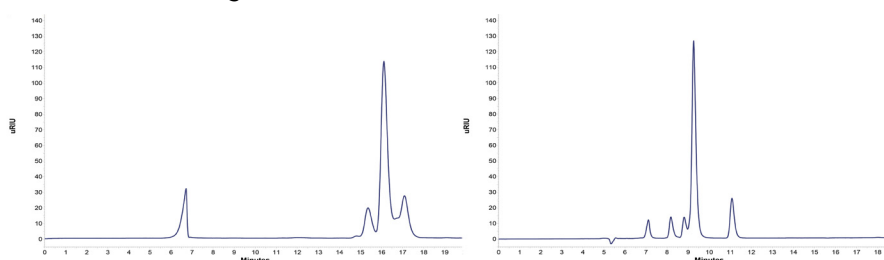

Fig. A1 Chromatograms of 1:10 dilution of fermentation mash; left Eurokat Na; right Eurokat H; 1 xylitol; 10 μL injection

Overload experiments

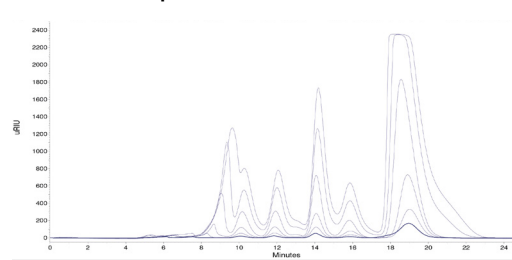

Fig. A2 Overload studies with semi-preparative Eurokat Ca and fermentation mash; 50 μL , 100 μL , 200 μL , 500 μL , 1000 μL , 1500 μL injection

ADDITIONAL MATERIALS AND METHODS

Tab. A1 Comparison of properties and method parameters of applied Eurokat columns

Column	Column Dimensions	Particle (μm)	Eluent	Flow rate (mL/min)	Injection Volume (μL)	Temperature ($^{\circ}\text{C}$)	Column Volume (mL)
Eurokat H	300 \times 8 mm + 30 \times 8 mm	10	H ₂ O/5 mM H ₂ SO ₄	0.5	20	75	15
Eurokat Ca, Na	300 \times 8 mm + 30 \times 8 mm	10	H ₂ O	0.6	20	60	15
Eurokat Ca	250 \times 16 mm	25-56	H ₂ O	2.5	10000	75	50

AZURA Analytical system

Instrument	Description	Article No.
Pump	AZURA P 6.1L, HPG, 10mL, SSt	APH35EA
Autosampler	3950 analytical version	A50070
Detector 1	AZURA DAD 2.1L	ADC01
Flow Cell	High Sensitivity LightGuide 50 mm, 6 μL	AMD59
Detector 2	AZURA RID 2.1L	ADD31
Thermostat	AZURA CT 2.1	A05852
Software	OpenLAB [®] CDS EZChrom Edition	A2600-1

AZURA Preparative system

Instrument	Description	Article No.
Pump	AZURA P 6.1L, HPG; 50 ml, SSt	APH38FA
Autosampler	3950 preparative version	A50054-1
Detector	AZURA RID 2.1L	ADD31
Thermostat	AZURA CT 2.1	A05852
Fraction collector	Foxy R1	A59100
Software	OpenLAB [®] CDS EZChrom Edition	A2600-1

RELATED KNAUER APPLICATIONS

[VFD0160](#) - Determination of sugars and natural sugar substitutes in different matrices

[VFD0161](#) - Determination of sugars in honey using HILIC separation and RI detection

[VFD0155](#) - Semi preparative xylitol purification with dedicated sugar purification system

[VSP0013](#) - Simplified scale up for sugars with the AZURA RID 2.1L extended dynamic range option

Determination of aflatoxin M1 in milk

Juliane Böttcher, Kate Monks; applications@knauer.net
KNAUER Wissenschaftliche Geräte GmbH, Hegauer Weg 38, 14163 Berlin;
www.knauer.net



SUMMARY

This application describes a fast and isocratic method for the determination of aflatoxin M1 in milk and raw milk with an easy post column derivatization step using a UVE photochemical reactor. Furthermore, required sample preparation via solid phase extraction (SPE) is recommended.

INTRODUCTION

Aflatoxins are the best known group of mycotoxins that were named after the main fungi strain producing them as secondary metabolites namely *Aspergillus flavus*. Aflatoxins are also produced by *Aspergillus parasiticus* and to a smaller extent also by other strains. Aflatoxins can accumulate on crops in the field or during storage of agricultural products, especially under warm and humid conditions. Unfortunately, these substances can persist long after the fungi have

been killed and therewith contaminate foods. The more common aflatoxins, which include G2, G1, B2, and B1, have been identified as contaminants in cattle feed. Upon ingestion, aflatoxins B2 and B1 are metabolized to M2 and M1, potentially adulterating dairy products. The maximum aflatoxin M1 level set by the U.S. Food and Drug Administration and European Commission is 0.5 µg/L. [1,2].



Determination of aflatoxin M1 in milk

RESULTS

First, the analytical method was developed using a standard solution. **Fig 1** shows the fluorescence chromatogram with post column derivatization using the UVE photochemical reactor for an aflatoxin M1 standard at a concentration of 1 $\mu\text{g}/\text{mL}$. To make sure that the legal limit value is detectable, a milk sample was spiked with aflatoxin M1 to a concentration of 0.5 $\mu\text{g}/\text{L}$ and pretreated with online solid phase extraction. **Fig 2** shows an overlay of the spiked milk sample after sample preparation and the aflatoxin M1 standard. Although matrix effects occur through SPE pretreatment it was possible to quantify aflatoxin M1 in the

measured milk sample spiked down to 0.5 $\mu\text{g}/\text{L}$. For sample pretreatment following SPE procedure was conducted [4]: 20 mL of the spiked milk were diluted with 30 mL distilled water. A CHROMABOND® C18 ec SPE column was conditioned with 10 mL methanol and subsequently with 10 mL water. After this the sample was slowly forced or aspirated through the column. The SPE column was washed with 10 mL water and 10 mL n-hexane. Afterwards the column was dried for 10-20 min at 50°C or overnight at ambient temperature. After drying the sample was eluted with 3 mL acetonitrile.

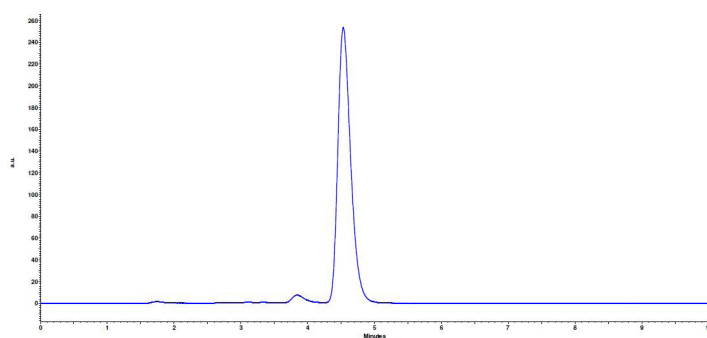

Fig. 1 Chromatogram aflatoxin M1 standard 1 $\mu\text{g}/\text{mL}$

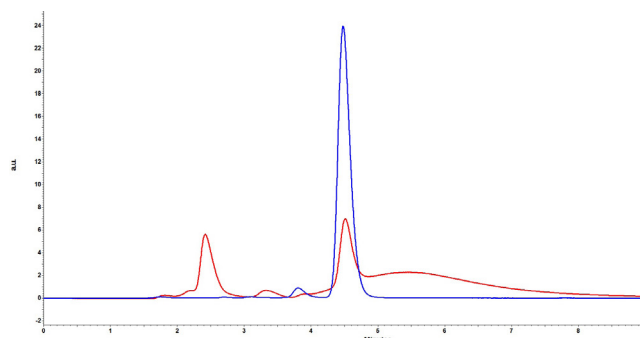

Fig. 2 Overlay of spiked milk sample after SPE (red) and standard (blue)

MATERIALS AND METHODS

An AZURA Analytical HPLC Plus system was used for this application. It consisted of an AZURA P 6.1L LPG pump, an autosampler 3950, an AZURA CT 2.1 column thermostat, the UVE photochemical reactor and fluorescence detector RF-20Axs. The analytical method was run isocratically at a flow rate of 0.8 mL/min

with a mixture of water, methanol and acetonitrile 60:25:15 (v/v). The column thermostat was set to 30 °C and the detector was set to excitation 365 nm/emission 455 nm. The sensitivity was adjusted to high with a gain of 16. The used column was filled with KNAUER Eurospher II 100-3 C18 silica.

CONCLUSION

Using the UVE photochemical reactor for post column derivatization in combination with the AZURA Analytical HPLC system and fluorescence detection, the valid maximum limit values of 0.5 µg/L for aflatoxin M1 in milk and other dairy products could be quantified.

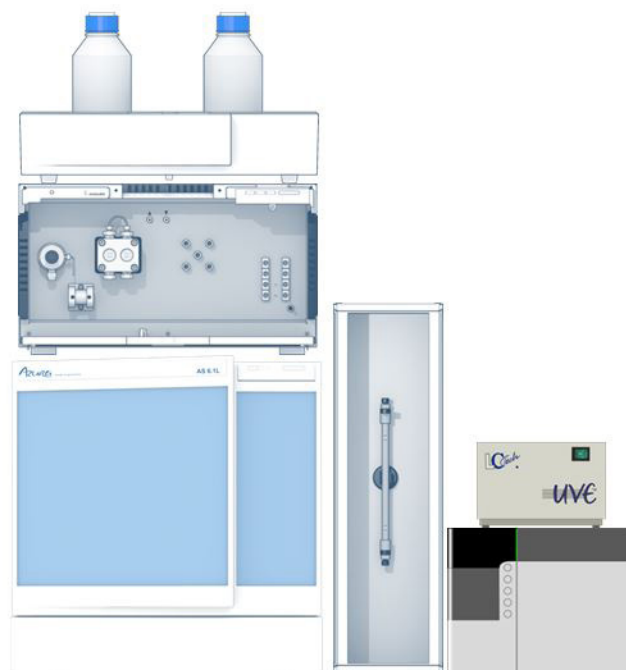

REFERENCES

- [1] FDA Mycotoxin Regulatory Guidance, National Grain and Feed Association 1250 Eye St., N.W., Suite 1003, Washington, D.C., 20005-3922 August 2011, <http://www.ngfa.org/wp-content/uploads/NGFAComplianceGuide-FDARegulatoryGuidance-forMycotoxins8-2011.pdf>
- [2] COMMISSION REGULATION (EC) No 1881/2006 of 19 December 2006 setting maximum levels for certain contaminants in foodstuffs, Official Journal of the European Union, L 364/5 - L 364/24, 20.12.2006, <http://eur-lex.europa.eu/legal-content/EN/TXT/PDF/?uri=CELEX:32006R1881&qid=1487915647230&from=EN>
- [3] <http://www.mn-net.com/DesktopModules/TabID/10160/default.aspx>

ADDITIONAL RESULTS

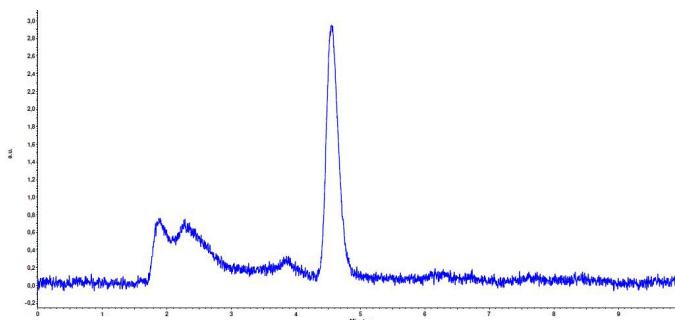
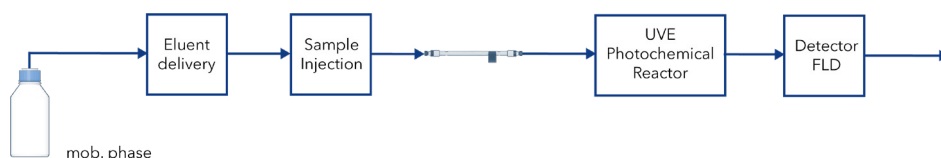

Fig.A1 Chromatogram aflatoxin M1 standard 0.001 µg/mL

ADDITIONAL MATERIALS AND METHODS

Tab.A1 Method parameters

Eluent A	Water/Methanol/Acetonitrile 60:25:15		
Gradient	Isocratic 100 % A		
Flow rate	0.8 mL/min	System pressure	260 bar
Column temperature	30 °C	Run time	10 min
Injection volume	10 µL	Injection mode	Full loop
Detection wavelength	Ex 365 nm/Em 455 nm	Data rate	5 Hz
		Time constant	0.2 s



Tab.A2 System configuration

Instrument	Description	Article No.
Pump	AZURA P 6.1L, LPG 10mL, SSt	APH34EA
Autosampler	3950 analytical version	A50070
Detector	RF-20Axs	A59201
Thermostat	AZURA CT 2.1	A05852
Software	OpenLAB CDS EZChrom Edition	A2600-1
Column	Vertex Plus Column, 150x3 mm ID with precolumn, Eurospher II 100-3 C18	15XE181E2G
Post column derivatisation	UVE photochemical reactor	A07547

RELATED KNAUER APPLICATIONS

[VFD0146](#) - Sensitive online SPE determination of Bisphenol A in water samples

[VFD0159](#) - Alternaria alternata - determination of main metabolites

[VFD0158](#) - Zearalenone and its major metabolites - a simple isocratic method

GPC cleanup of olive oil samples

Michaela Schulze, Kate Monks; applications@knauer.net
KNAUER Wissenschaftliche Geräte GmbH, Hegauer Weg 38, 14163 Berlin; www.knauer.net



SUMMARY

This work describes a sample cleaning method for analyzing pesticide residues in olive oil in preparation for an HPLC analysis. Pesticides were separated from the oil matrix by size exclusion/gel permeation chromatography (GPC) according to US EPA SW-846 method 3640A. The GPC material used in this study was BioBeads SX-3 and the GPC solvent system was cyclohexane/ethyl acetate (1:1, v/v). The optimized GPC purification technique was carried out with a KNAUER AZURA® GPC Cleanup System for automated sample cleaning.

INTRODUCTION

GPC is extensively used as an effective post-extraction cleanup procedure for removing high molecular weight interferences such as lipids, proteins, and polymers from sample extracts. The efficiency of BioBeads SX-3 with an organic solvent to separate multi-pesticide residues has been extensively documented [1-3].

The GPC technique is appropriate for both polar and non-polar analytes so it can be effectively used to cleanup extracts containing a broad range of compounds. To demonstrate the flexibility of the sample cleaning method, the olive oil samples investigated were spiked with different types of compounds.

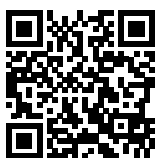

GPC cleanup of olive oil samples

RESULTS

Fig 1 shows the chromatogram of the GPC calibration standard eluted with cyclohexane/ethyl acetate (1:1, v/v). The three detected pesticides were baseline separated and could be identified easily. **Fig 2** shows the elution profile of one olive oil sample containing different types of pesticides. It can be seen that all pesticides were detected with the US EPA method

3640A. Compared to the measurement of the standard solution, the spiked sample showed less matrix effects. This means that all interfering high molecular elements were removed during clean up. The recovery for all of these compound classes was higher than 70 %.

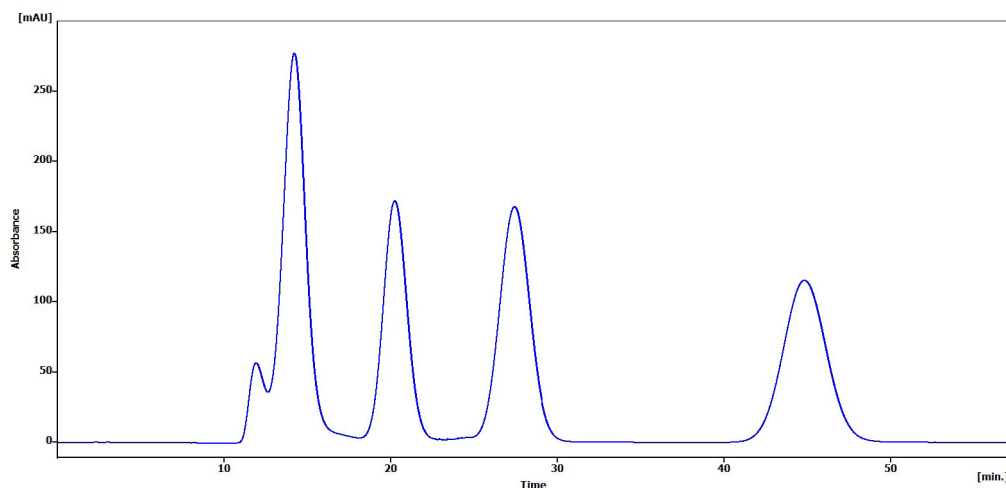

Fig. 1 Chromatogram of US EPA method 3640A calibration standard containing
1) Corn oil matrix, 2) Bis-(2-ethylhexyl)phthalate, 3) Methoxychlor, 4) Perylene

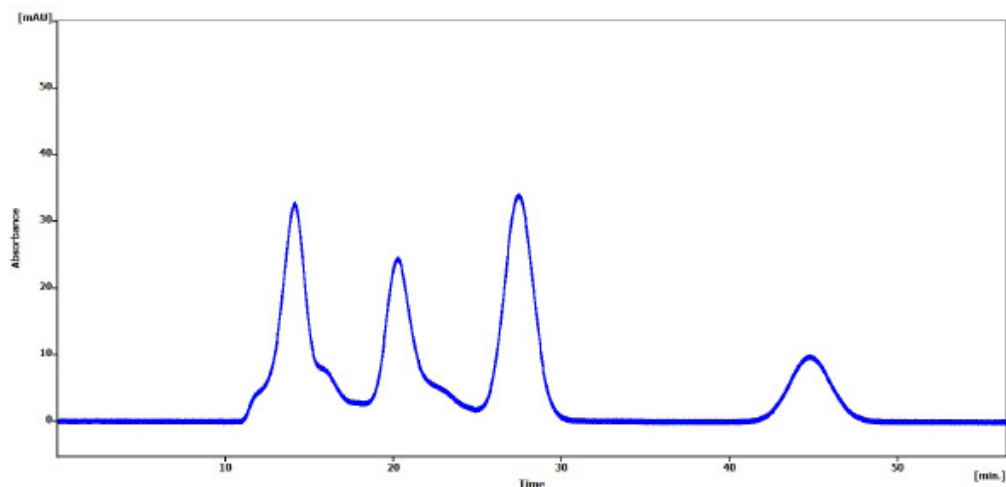

Fig. 2 Chromatogram of olive oil sample, spiked with pesticides:
1) Olive oil matrix, 2) Bis-(2-ethylhexyl)phthalate, 3) Methoxychlor, 4) Perylene

MATERIALS AND METHODS

This study used the KNAUER AZURA GPC Cleanup System which automates the GPC cleanup process. The system comprising of the two AZURA ASM 2.1L Assistant modules with different valves, a pump, and a UV detector. The compounds were detected at 254 nm wavelength with the AZURA UVD 2.1S UV detector with 10 Hz data rate. The two 16-port multiposition valves used here enabled the loading of up to 15 oil samples (1 mL or 5 mL samples loops). Moreover, the pesticide fraction was collected in a round-bottomed flask between the elution of corn oil by a third 16-port multiposition valve. The glass column with BioBeads SX-3 was flushed with cyclohexane/ethyl acetate (1:1, v/v) for an extended period at a flow rate of 5 mL/min. To determine the elution profile of the GPC column, a calibration solution was prepared in cyclohexane/ethyl acetate containing the following analytes: corn oil (25 g/L), bis(2-ethylhexyl) phthalate (1 g/L), methoxychlor (0.2 g/L), and perylene (0.02 g/L). The calibration solution was injected after solvent flow and column pressure were established. The eluates were collected based on the UV traces of the four eluates. For further analysis purposes with GC, DC or HPLC techniques (not described here), the various oil sample fractions collected were carefully evaporated under a nitrogen stream, dispensed in 1 mL of a suitable solvent and filtered using a 0.45 μm syringe filter.

REFERENCES

- [1] Chamberlain, S.J. Determination of multi-residues in cereal products and animal feed using gel-permeation chromatography. *Analyst* (1990), 115:1161-1165
- [2] Di Muccio, A.; Ausili, a.; Versori, L; Camoni, I; Dommarco, t; Ganibetti, L; santillo, A and Versori, F. Single-step multi-residue clean-up for organophosphate pesticide residue determination in vegetable oil extracts by gas chromatography. *Analyst* (1990), 115: 1167-1169
- [3] Guardia-Rubio, M; Fernandez-De Cordova, M.L.; Ayory-Canada, M.J. and Ruiz-Medina, A. Simplified pesticide multi-residue analysis in virgin olive oil by gas chromatography with thermoionic specific, electron-capture and mass spectrometric detection. *J. of Chrom. A* (2006) Volume 1108, 231-239

CONCLUSION

GPC sample preparation is a useful tool for separating small amounts of pesticides from high molecular weight matrices such as olive oil. The KNAUER AZURA® GPC Cleanup System is particularly well-suited for sample preparation in pesticide analysis but can also be easily adapted to other laboratory procedures to perform a large variety of GPC sample preparation tasks. The arrangement of the 15 sample loops and one wash loop avoids cross contamination hence allowing a robust sample preparation procedure.

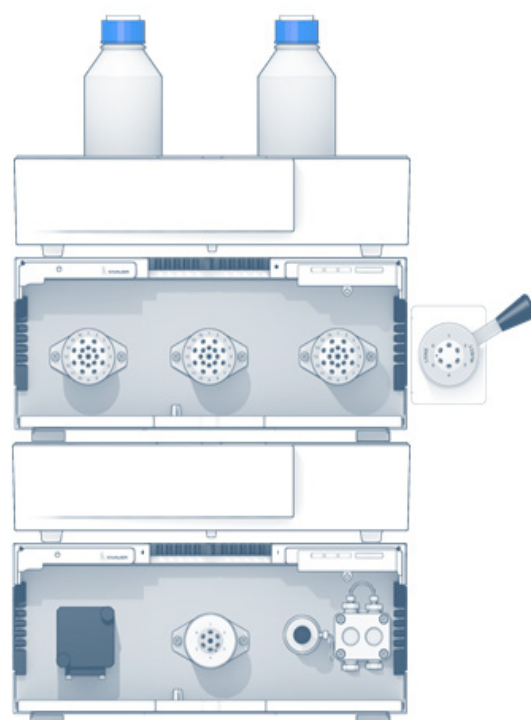

ADDITIONAL MATERIALS AND METHODS

Tab.A1 Sample preparation

StandardsQ	Prepared and diluted with Cyclohexane/ethyl acetate (1:1, v/v)
1. Corn oil	25 g/L
2. Bis-(2-ethylhexyl)phtalate	1 g/L
3. Methoxychlor	0.2 g/L
4. Perylene	0.02 g/L

Tab.A2 Method parameters

Eluent A	Cyclohexane/ethyl acetate (1:1, v/v)		
Isocratic	Time [min]	% A	% B
	0	100	0
	60	100	0
Flow rate	5 mL/min	System pressure	0.6 bar
Column temperature	25°C	Run time	60 min
Injection volume	1 mL	Injection mode	Full loop
Detection wavelength	254 nm	Data rate	10 Hz
		Time constant	0.1 s

Tab.A3 System configuration

Instrument	Description	Article No.
Assistant 1	AZURA ASM 2.1L, left: single variable wavelength UV detector middle: 6 port 2 position injection valve, 1/16" connectors right: Pump with pressure sensor, 10 mL pump head, SSt	AYCAEABA
Assistant 2	AZURA ASM 2.1L, left: 16 port multi position valve, 1/16" connectors middle: 16 port multi position valve, 1/16" connectors right: 16 port multi position valve, 1/16" connectors	AYGAGAGA
Flow cell	UV, 3mm, 2 µL	A4042
GPC tubing guide	16 sample loops with 1 ml	A5329-2
Software	ClarityChrom	A1670-9
Column	BioBeads SX-3	B41
Injection valve	Manual injection valve 6-Port/2-position, 1/16" connectors	AVI26BC



Dedicated AZURA® GPC Cleanup System

RELATED KNAUER APPLICATIONS

[VEV0081](#) - GPC vs. SPE and subsequent determination of polycyclic aromatic hydrocarbons using GC/MS

[VEV0082](#) - GPC cleanup method for soil samples before PAHs analysis

[VFD0166](#) - LC-FLD analysis of 4 PAHs in olive oil samples using AZURA® GPC Clean-up System

Semi preparative xylitol purification with dedicated sugar purification system

Yannick Krauke, Matthias Lübbert, Kate Monks; applications@knauer.net
KNAUER Wissenschaftliche Geräte GmbH, Hegauer Weg 38, 14163 Berlin; www.knauer.net



SUMMARY

Xylitol is used as sweetener in the food industry and is generated by chemical conversion of xylose. Here, xylitol was purified from fermentation mash by microbial xylose conversion. The AZURA® Sugar purification system with the AZURA RID 2.1L refractive index detector was used for this semi - preparative purification in combination with polymer-based Eurokat Ca column.

INTRODUCTION

The second generation of bio refinery is using biomass with low contents of C6 sugars such as wheat straw. This biomass is often rich in the C5 sugar xylose which is normally not used as a carbon source by microorganisms for ethanol production. Xylose is chemically converted to xylitol which is a five-carbon sugar alcohol occurring in nature mostly in low concentrations and its extraction is too unproductive. It has found its application i.e. food industry as an artificial sweetener in chewing gums. It has been shown that xylose can be converted to xylitol by different yeast and bacteria

species [1, 2]. The microbial conversion of xylose to xylitol, followed by a simple purification process, presents an economical and environmentally-friendly alternative [3]. A previous study already revealed the feasibility of semi-preparative xylitol purification from fermentation mash (VFD0150). In this study, method optimization for xylitol purification was performed with the same stationary phase material. The AZURA RID 2.1L detector could be used for this task due to its ability to sustain flow rates up to 10 mL/min and 5 bar back pressure.



Semi preparative xylitol purification with dedicated sugar purification system

RESULTS

The separation profile of the semi-preparative Eurokat Ca 150 × 20 mm column was tested by injection of 0.5 mL fermentation mash (FM; 1:2 dilution). Overlay of the resulting chromatogram with chromatograms of standard solution and retention time comparison identified xylitol, mannitol, glycerol and xylose in the sample (see add. results **Fig. A1**). Also at larger injection volumes (1 mL, 2 mL) xylitol could still be baseline separated from mannitol (**Fig. 1**). Due to the shorter column length (150 × 20 mm) and faster flow rate (4 mL/min) the xylitol peak eluted earlier (approx. 13 min) compared to previous study where it eluted

at 19 min using a longer column (250 × 16 mm) and lower flow rate (2.5 mL/min) (VFD0150). After injection of 2 mL FM a 12 mL fraction of xylitol was recovered (**Fig. 1**, blue bracket). The analysis of the 12 mL xylitol fraction and subsequent comparison with chromatograms of a xylitol standard (1 mg/mL) and FM revealed no contaminations in the xylitol fraction (**Fig. 2**, red line). Measurements of xylitol concentration in the FM showed an initial concentration of approx. 60 mg/mL xylitol and a concentration of approx. 5.6 mg/mL xylitol in the fraction, revealing an about 11 fold dilution of xylitol by batch purification.

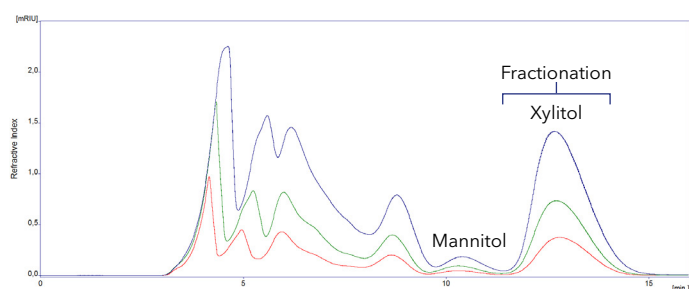

Fig. 1 Chromatogram overlay of different injection volumes from fermentation mash (1:2 dilution); red - 0.5 mL, green - 1 mL, blue - 2 mL; blue brackets-fractionation area 2 mL injection; EK Ca 150 x 20 mm; 4 mL/min; 60 °C

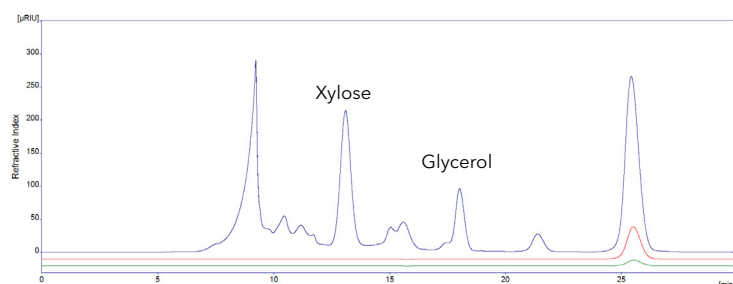

Fig. 2 Overlay of analytical chromatograms; blue - fermentation mash (1:2 dilution); red - fractionation sample from Fig. 1; green - xylitol standard 1 mg/mL; 10 µl each; EK Ca 300 x 8 mm; 75 °C

Acknowledgement: This project has received funding from the European Union's Seventh Framework Program for research, technological development and demonstration under grant agreement no FP7-KBBE-2013-7-613802.



MATERIALS AND METHOD

The AZURA sugar purification system consists of an assistant AZURA ASM 2.1L with a 12 port multi position valve (for fractionation) and 50 mL pump and an AZURA RID 2.1L refractive index detector. Eurokat Ca 150 × 20 mm column (sulfonated cross-linked styrene-divinylbenzene copolymer) with 25–56 µm particles was used for purification. The column was heated with a heating jacket to 60 °C. Purification run was in isocratic mode for 16 min at 4 mL/min. Different injection volumes were tested. The data rate was set to 5 Hz, time constant 0.02 sec.

CONCLUSION

Two main results were achieved with this study: 1. Optimization of the batch xylitol purification process and 2. Application of the AZURA RID 2.1L refractive index detector for semi-preparative sugar purification at higher flow rates. Xylitol was purified with a purity of >99 % and recovery of >99 % from fermentation mash of microbial xylose to xylitol conversion. Elution time (13 min) and temperature (60 °C) was reduced and injection volume (2 mL) increased when compared to early study ([VFD0150](#)).

REFERENCES

- [1] Tamburini E.; Costa S., Gabriella Marchetti M., Pedrini P. *Biomolecules* 5: 1979–1989 (2015)
- [2] Hernandez-Perez A.F., Vaz de Arruda p., Gracias de Almeida Felipe M.d.FTI 20037. *Brazilian Journal of microbiology* 47: 489-496 (2016)
- [3] Chen X., Jian Z.-H., Chen S., Qin W. *Int. J. Biol. Sci.* 6(7): 834–844 (2010)

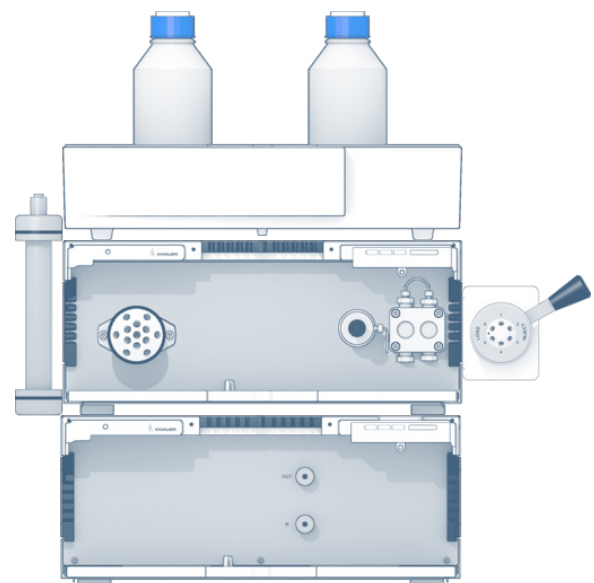

ADDITIONAL RESULTS

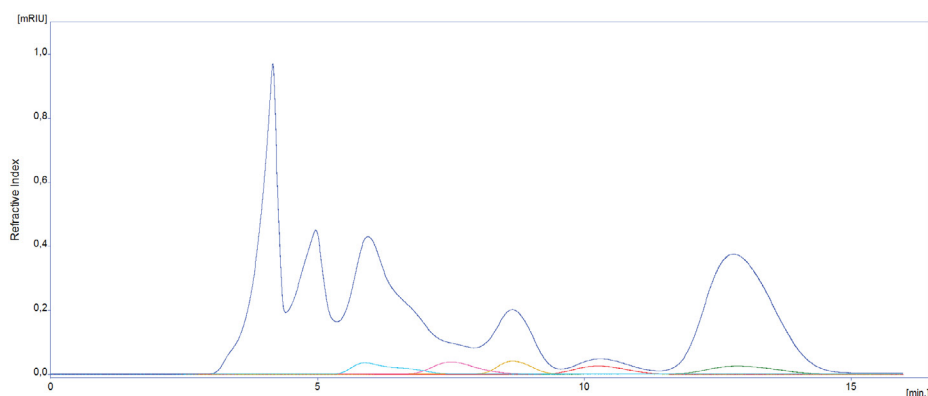

Fig. A1 Chromatograms of 0.5 mL injection of fermentation mash (1:2 dilution) and standards (2 mg/mL each); blue - FM; EK Ca 150 x 20 mm; 60 °C; 4 mL/min

ADDITIONAL MATERIALS AND METHODS

Tab. A1 Method parameters (preparative purification)

Eluent A	H ₂ O _{dd}		
Gradient	isocratic, 100 % A		
Flow rate	4 mL/min	System pressure	5.5 bar
Column temperature	60 °C	Run time	16 min
Injection volume	0.5 mL, 1 mL, 2 mL	Injection mode	Full loop
Detection wavelength	RI	Data rate	5 Hz
		Time constant	0.02 sec

Tab. A2 Method parameters (fraction analysis)

Eluent A	H ₂ O _{dd}		
Gradient	isocratic, 100 % A		
Flow rate	0.5 mL/min	System pressure	24 bar
Column temperature	75 °C	Run time	30 min
Injection volume	20 µL	Injection mode	Full loop
Detection wavelength	RI	Data rate	5 Hz
		Time constant	0.05 sec

Tab. A3 System configuration

Dedicated Sugar purification system			Dedicated System Sugar Analytic		
Instrument	Description	Article No.	Instrument	Description	Article No.
Detector	AZURA RID 2.1L	ADD31	Detector	AZURA RID 2.1L	ADD31
Injection	Manual 6-port/3-channel injection valve	A1357	Injection	Manual 6-port/3-channel injection valve	AVI26BC
Assistant	AZURA ASM 2.1L: Left: 12 port Multiposition valve as fractionation valve, 8" Middle: - Right: AZURA P 4.1S, 50 mL SSt	AYFALXBD	Pump	AZURA P 6.1L, isocratic, 10 ml, SSt	APH30EA
Thermostat	Customized heating sleeve, 150 x 20 mm Temperature Control for KNAUER Column Heating Sleeve	A57026 A57024	Thermostat	AZURA CT 2.1	A05852
Column	Eurokat Ca 150 x 20 mm	15PX360EKX	Column	Vertex Plus Column 300 x 8 mm Eurokat H, 10 µm	30GX340EKN
Software	ClarityChrom® Prep 6.1.0	A1685-9	Software	ClarityChrom 6.1.0	A1670-9

RELATED KNAUER APPLICATIONS

[VFD0160](#) - Determination of sugars and natural sugar substitutes in different matrices

[VFD0161](#) - Determination of sugars in honey using HILIC separation and RI detection

[VSP0013](#) - Simplified scale up for sugars with the AZURA RID 2.1L extended dynamic range option

[VFD0150](#) - Alternative xylitol extraction via hplc purification from fermented biomass

Determination of osmolality of isotonic and non-isotonic beverages

Juliane Böttcher, Till Myrach, Kate Monks; applications@knauer.net
KNAUER Wissenschaftliche Geräte GmbH, Hegauer Weg 38, 14163 Berlin;
www.knauer.net



SUMMARY

In the last years isotonic beverages have become more and more popular. Almost every drink is available in an isotonic version. But what does isotonic mean and what are its benefits? How can be checked that beverages are really isotonic? And have you ever heard of osmolality?

INTRODUCTION

Every liquid containing substances such as minerals, carbohydrates, or proteins has an osmotic pressure. Isotonic or iso-osmotic means that the liquid has the same osmotic pressure as human blood. This feature allows an accelerated ingestion of salt and sugars from the drink which results in a faster recovery after sporting activity. A fast and easy way to check how many osmotically active molecules are solved in a

liquid is to determine its osmolality. The osmolality is a general measure for the number of molecules and is commonly given in mOsmol/kg solvent. An isotonic drink **Fig 1** is defined to have an osmolality of $300 \pm 10\%$ mOsmol/kg. These limit values are for example fixed by the European Food Safety Authority, short EFSA [1].

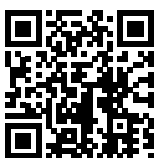

Determination of osmolality of isotonic and non-isotonic beverages

RESULTS

Six different samples of isotonic and non-isotonic drinks were measured, the osmolality was determined using the K-7400S osmometer which correlates freezing point depression with osmolality. The osmometer was calibrated in a range of 0-850 mOsmol/kg for isotonic samples and in a range from 0-2000 mOsmol/kg for non-isotonic drinks, respectively. Ten replicates were measured for each sample using a sample volume

of 150 μ L. The diagram in Fig 2 shows the average values of osmolality for the isotonic samples together with the EFSA limits. The non-isotonic beverages have a much higher osmolality. For samples of caffeine containing soft drink and beer osmolalities of 644 mOsmol/kg and 1008 mOsmol/kg, respectively, were determined. As alcohol is also depressing the freezing point, the osmolality



Fig. 1 Isotonic beverages

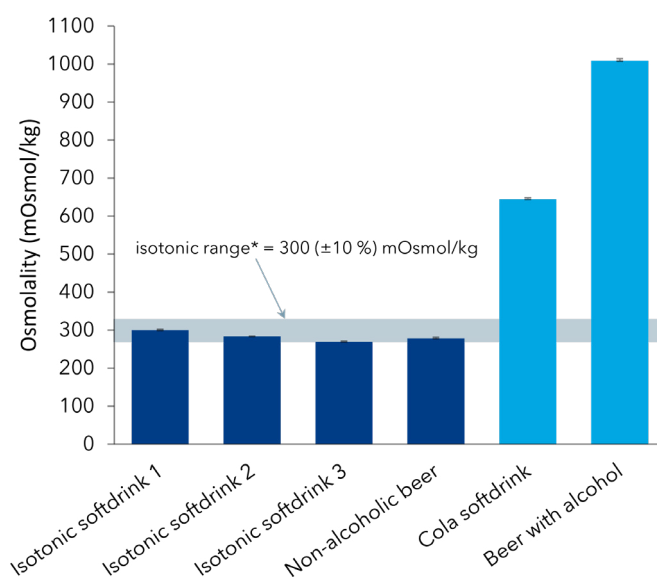

Fig. 2 Measured osmolalities of four different as isotonic declared as well as two non-isotonic beverages. Graph shows average values and standard deviations of 10 replicates

MATERIALS AND METHOD

All measurements were made with the KNAUER K-7400S Semi-Micro Osmometer. The used calibration standards had osmolality values of 300, 850 and 2000 mOsmol/kg. The system parameters were set to -8 °C for freeze and -16 °C for cooling limit. The samples of soft drinks and beer were degassed using an ultrasonic bath to remove the carbon dioxide. Then 150 µL of the samples were transferred to a plastic sample tube.

CONCLUSION

The osmolalities of all analyzed isotonic samples were within the EFSA defined range. In general, the values were below 300 mOsmol/kg, which could be due to the sample preparation (degassing) and a subsequent reduction of carbon dioxide. Due a higher content of solved compounds like sugars or alcohol, in the case of beer, non-isotonic beverages showed significantly higher osmolalities.

REFERENCES

[1] Scientific Opinion on the substantiation of health claims related to carbohydrate-electrolyte solutions and reduction in rated perceived exertion/effort during exercise (ID 460, 466, 467, 468), enhancement of water absorption during exercise (ID 314, 315, 316, 317, 319, 322, 325, 332, 408, 465, 473, 1168, 1574, 1593, 1618, 4302, 4309), and maintenance of endurance performance (ID 466, 469) pursuant to Article 13(1) of Regulation (EC) No 1924/2006 EFSA Panel on Dietetic Products, Nutrition and Allergies (NDA); <http://onlinelibrary.wiley.com/doi/10.2903/j.efsa.2011.2211/pdf>



ADDITIONAL RESULTS

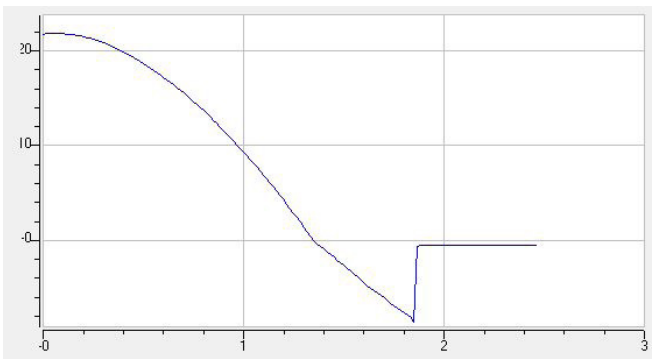

Fig.A1 Temperature-time-curve

Tab.A1 Average osmolalities of isotonic and non-isotonic beverages

Beverage	Isotonic softdrink 1	Isotonic softdrink 2	Isotonic softdrink 3	Non-alcoholic beer	Cola softdrink	Beer with alcohol
Average Osmolality (n=10)	300	284	270	278	644	1009
σ	2.7	0.7	1.6	3.2	3.8	5.7

ADDITIONAL MATERIALS AND METHODS

Tab.A2 Method parameters

Calibration 1	0 mOsmol/kg	300 mOsmol/kg	850 mOsmol/kg
Calibration 2	0 mOsmol/kg	850 mOsmol/kg	2000 mOsmol/kg
Sample volume	150 μ L		
Freeze	-8 °C		
Cooling limit	-16 °C		

Tab.A3 System configuration

Instrument	Description	Article No.
Osmometer	KNAUER K-7400S Semi-Micro Osmometer	A0006AC
Sample tubes	Approved plastic sample tubes, 500 pcs.	A0272
Software	EuroOsmo 7400	A3705

RELATED KNAUER APPLICATIONS

[VPH0064](#) - Quality control of pharmaceutical solutions by determination of osmolality

Simulated Moving Bed (SMB) - a powerful tool for continuous purification of xylitol



Yannick Krauke, Christian Benkhäuser, Matthias Lübbert, Kate Monks; applications@knauer.net
KNAUER Wissenschaftliche Geräte GmbH, Hegauer Weg 38, 14163 Berlin; www.knauer.net

SUMMARY

Simulated moving bed chromatography (SMBC) was applied for the purification of xylitol from fermentation mash of a fed batch culture. This process enabled to purify xylitol with nearly 100 % purity and recovery. Thus, allowing large scale purification of xylitol from biological xylose-xylitol conversion process.

INTRODUCTION

Within the European Valor Plus research project an alternative, biological way of xylose conversion was investigated. By using a *Candida* yeast strain, xylose from a hemicellulose hydrolysate was converted to xylitol. HPLC analysis of the fermentation mash revealed that the xylose to xylitol conversion was successful. Previous batch HPLC experiments (App. note VFD0155) indicated the potential to apply SMBC for this purification task. The separation was performed in isocratic mode on polymer based Eurokat

columns and the target substance xylitol eluted at the end of the chromatogram, all factors enabling a SMB process.

SMB chromatography is a continuous chromatography technique that separates binary or pseudo-binary mixtures into pure substances or fractions. Compared to traditional batch chromatography this process leads to higher yields of purified substances while consuming less eluent and packing material.

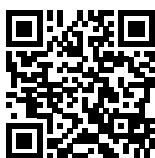

Simulated Moving Bed (SMB) – a powerful tool for continuous purification of xylitol

RESULTS

For the set-up of a SMB process several parameters of the separation process had to be determined. First, separation at three different temperatures (40°C, 50°C, 60°C) was tested. Separation at 50°C gave the favourable results and was therefore chosen for the purification. Overload studies with a 1:2 dilution of the fermentation mash revealed a nearly baseline separation of xylitol and mannitol. The chromatogram was divided in the raffinate fraction (all but xylitol) and the extract fraction (xylitol) (Fig 1). A substance eluting with the dead time of the system was determined and therefore an open-loop set-up was chosen with a waste outlet. The retention times of the substances and column porosity were determined and used for the process set-up. Using these values and the PurityChrom® MCC software the flow rates of the pumps and different zones in the process were obtained (Fig 2). After six cycles, samples from the extract, raffinate and waste were collected and analyzed. A fast analytical method (add. results Fig A1) enabled a rapid evaluation of the process. A more detailed

analysis revealed pure xylitol in the extract without any no xylitol was in the raffinate or waste (Fig 3 blue/green lines). With this SMB process 1.8 g/h xylitol were purified with 100 % purity and recovery. The yield of the SMB process is greater by the factor of seven than that of the batch process.

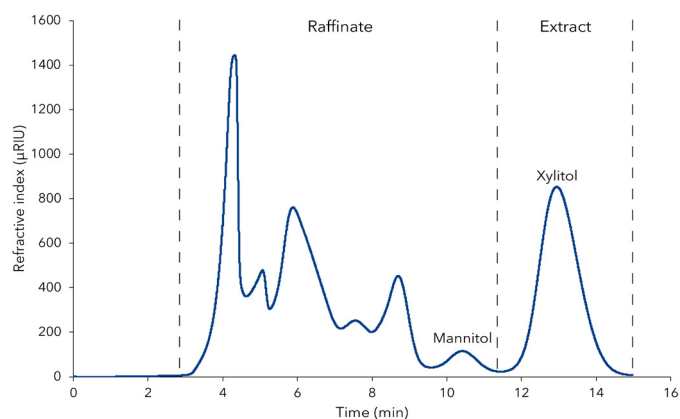

Fig. 1 Design of SMB process on chromatogram of fermentation mash with indication of the two fractions "raffinate" and "extract"; 1 mL injection; Eurokat Ca 150 x 20 mm, 25 -56 µm particles; 4 mL/min; 50°C

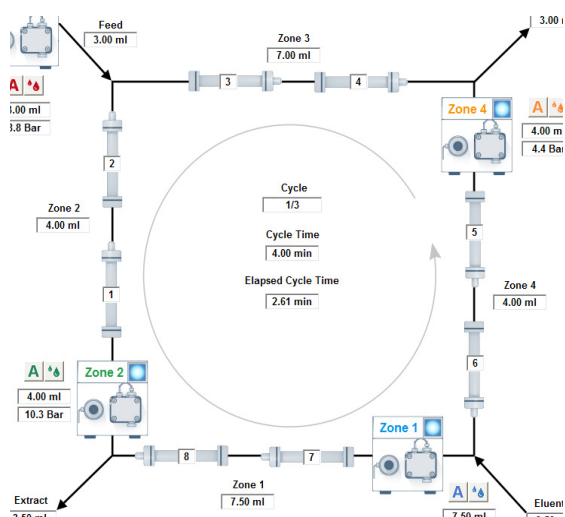

Fig. 2 Example scheme of the SMB process set-up with the four pumps, the out - and inlets, the 8 columns, four zones, indication of flow rates, pressure and cycle time; PurityChrom MCC software

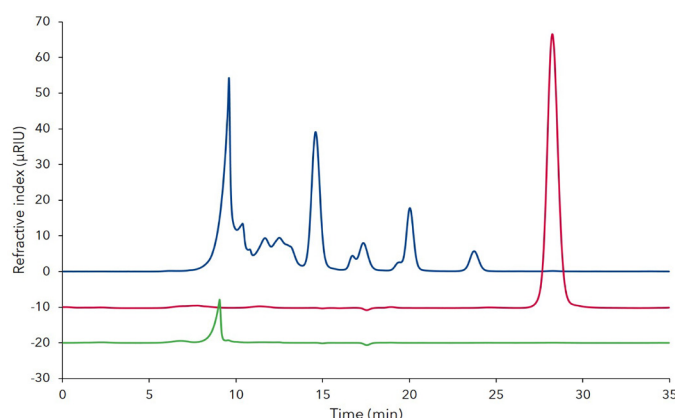

Fig. 3 Overlay of analytical chromatograms of raffinate/all but xylitol (blue), extract/xylitol (red) and waste (green) from the SMB process at the 6th cycle; 20 µL injection; Eurokat Ca 300 x 8 mm + pre-column; 10 µm particles, 0.5 mL/min; 75°C

MATERIALS AND METHOD

The SMB standard configuration consists of four AZURA® Assistans ASM 2.1L with seven multiposition valves and four P 4.1S Pumps (10/50 mL/min). Flow was controlled with two CORI-Flow M13 flow meters and temperature with the SMB oven. Eight identical Eurokat Ca 150 x 20 mm columns (sulfonated cross-linked styrene-divinylbenzene copolymer) with 25-56µm particles were used for purification. Analysis was performed with Eurokat Ca columns 300 x 8 mm, 10 µm particles and dedicated analytical sugar system (VFD0151).

CONCLUSION

Xylitol was purified with high purity and yield from fermentation mash using the AZURA® SMB system. This purification process allows a significant higher throughput and thus yield of xylitol as classical batch chromatography. The actual throughput is limited by the concentration of xylitol in the original mash. The developed method is very robust and separation of two to four times more concentrated mash should give same separation results.

Acknowledgement: This project has received funding from the European Union's Seventh Framework Program for research, technological development and demonstration under grant agreement no FP7-KBBE-2013-7-613802.

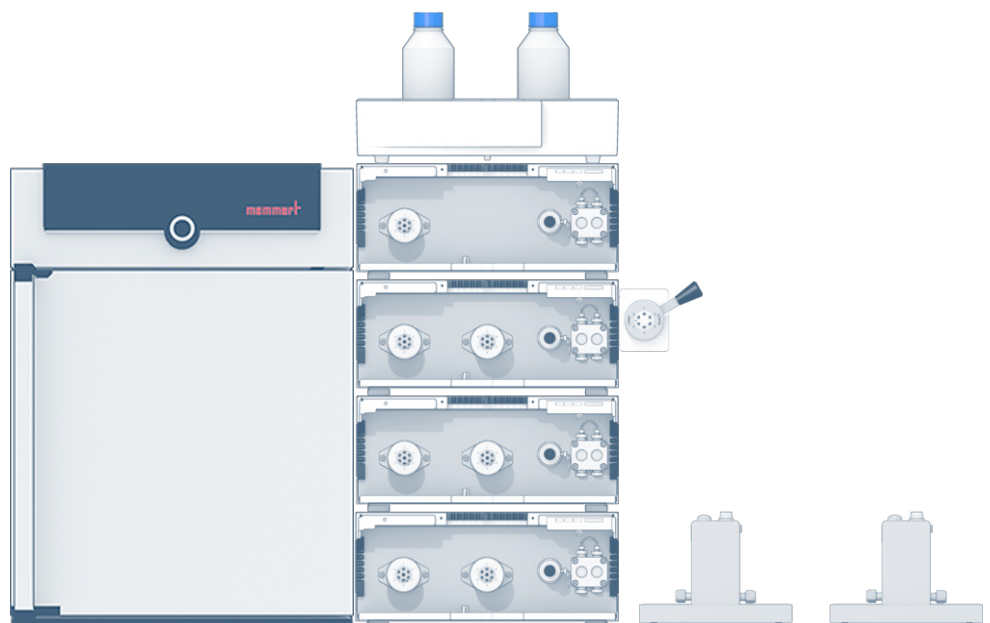

ADDITIONAL RESULTS

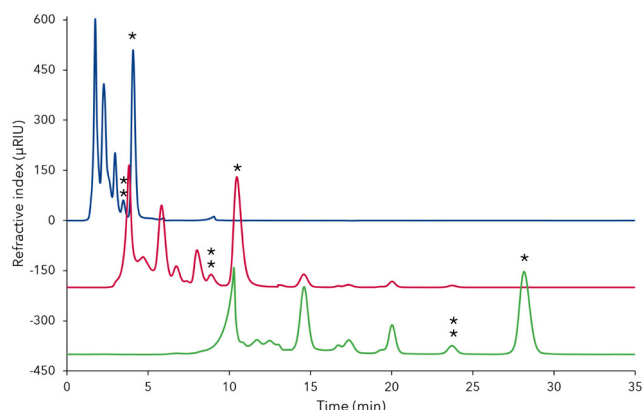

Fig. A1 Comparison of separation profiles of fermentation mash using Eurokat Ca columns with different length for a fast, analytical method; blue - 2 x 30 x 8 mm (0.7 mL/min), red (offset=-200) - 120 x 8 mm (0.7 mL/min), green (offset=-400) - 300 x 8 mm (0.5 mL/min); 20 µL injection; 75°C; * - xylitol, ** - mannitol

	Concentration (mg/mL)
Xylose	38.44 ± 0.13
Arabinose	8.67 ± 0.04
Glycerol	18.63 ± 0.13
Mannitol	5.59 ± 0.08
Xylitol	61.91 ± 0.34

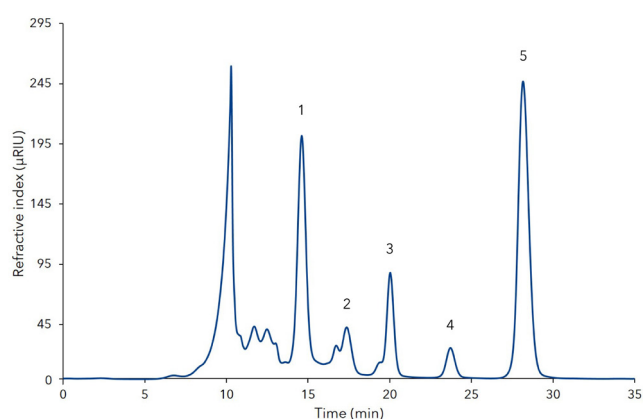

Fig. A2 Analytical chromatogram of fermentation mash showing five identified substances; 20 µL injection; Eurokat Ca 300 x 8 mm; 10 µm particles; 0.5 mL/min; 75°C; 1) xylose, 2) arabinose, 3) glycerol, 4) mannitol, 5) xylitol

Tab. A1 Results of data feed analysis presented as mean of four replicates with standard deviations indicated

ADDITIONAL MATERIALS AND METHODS

Tab. A2 Method parameters (SMB process)

	Feed (mL/min)	Eluent (mL/min)
In	0.5	8.36
Temperature	60°C	
Cycle time	54.60 min	

Tab. A3 System configuration (for Analytical system, see VDF0155)

Instrument	Description	Article No.
SMB system	AZURA Lab SMB system, biocompatible, seven 8-multiposition valves and four AZURA P 4.1S (10/50 mL/min) included in four Assitants ASM 2.1L.	A29000
Heating	SMB oven	A29900
Flow meter	2 x CORI Flow M13	A29800
Column	8 x Eurokat Ca 150 x 20 mm; 25-56 µm	15PX360EK
Software	PurityChrom® MCC	included in A29000



AZURA® Lab SMB System

RELATED KNAUER APPLICATIONS

[VFD0160](#) - Determination of sugars and natural sugar substitutes in different matrices

[VFD0155](#) - Semi preparative xylitol purification with dedicated sugar purification system

[VFD0150](#) - Alternative xylitol extraction via hplc purification from fermented biomass

[VSP0013](#) - Simplified scale up for sugars with the AZURA RID 2.1L extended dynamic range option

Zearalenone and its major metabolites - a simple isocratic method

Juliane Böttcher¹, Marina Müller², Kate Monks¹; applications@knauer.net

¹KNAUER Wissenschaftliche Geräte GmbH, Hegauer Weg 38, 14163 Berlin; www.knauer.net

²Leibniz-Zentrum für Agrarlandschaftsforschung e.V., Müncheberg, Germany



SUMMARY

The Food and Agricultural Organization of the United Nations estimated that 25 % of the global food are contaminated with mycotoxins [1]. Zearalenone (ZON) is a non-polar mycotoxin and a common contaminant in cereal grain used for animal and human food. It exerts an estrogenic activity that disrupts endocrine function in animals and possibly humans. The major metabolites of ZON are α - and β -zearalenol. All three components can be determined with a robust and simple isocratic method.

INTRODUCTION

Mycotoxins are secondary metabolites produced by mould fungus. The mycotoxin ZON, which is an intermediate catabolic product of filamentous fungi of the genus *Fusarium*, can be determined on almost all type of cereal. Although the overall toxicity is low, animal testing unraveled teratogenic, hepatotoxic, immunotoxic, genotoxic and cancerogenic effects [2, 3]. ZON furthermore influences the tumor progression of hormonal sensitive tissues as it shows

estrogen-like characteristics. α - and β -zearalenol are the main metabolites of ZON and mainly formed in the liver but also to a lesser extent in the intestines during first-pass metabolism [4, 5]. A relatively low proportion of β -zearalenol is formed from zearalenone compared to α -zearalenol in human [4]. α -zearalenol is about 3-to 4-fold more potent as an estrogen relative to zearalenone.



Zearalenone and its major metabolites – a simple isocratic method

RESULTS

All samples and standards were provided from the Leibniz-Zentrum für Agrarlandschaftsforschung (ZALF) e.V. In a range from about 2 ng up to 20 ng (absolute) calibrations of all three mycotoxins were determined using six different volumes of the standard ZALF 1. **Tab 1** gives a short summary of the retention times of the substances and achieved correlation coefficients of calibration. **Fig 1** shows the separation of the components in the standard ZALF 1. All peaks are baseline separated. The sample ZALF 2 is made

of extracted grain of wheat which were inoculated with a fungus of the genus *Fusarium*. For the determination of zearalenol the sample ZALF 2 was used as provided. For the determination of zearalenone a dilution was necessary. **Fig 2** shows the measurement of the sample ZALF 2 with and without dilution. With quantification based on the determined calibration curves a concentration of 2.80 ng/μL for β-zearalenol, 0.29 ng/μL for α-zearalenol and 390 ng/μL for zearalenone were calculated.

Tab. 1 Retention times and correlation coefficients of β-Zearalenol, α-Zearalenol and Zearalenone calibration

Peak	Substance	Retention time	Correlation coefficient
1	β-Zearalenol	7.573 min	0.99985
2	α-Zearalenol	11.160 min	0.99997
3	Zearalenone	12.331 min	0.99997

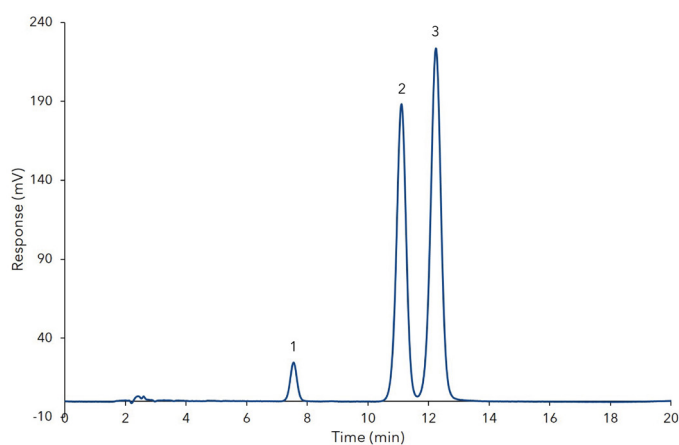

Fig. 1 Standard ZALF 1: 1) β-Zearalenol, 2) α-Zearalenol, 3) Zearalenone

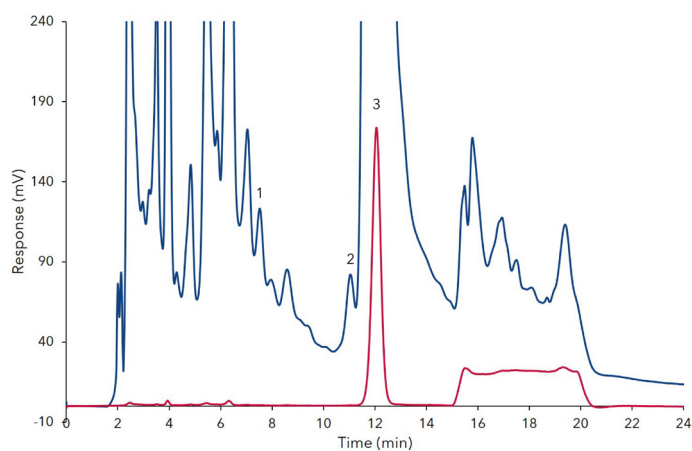

Fig. 2 Sample ZALF 2, blue - without dilution, red - 1:50 dilution, 1) β-Zearalenol, 2) α-Zearalenol, 3) Zearalenone

MATERIALS AND METHODS

An AZURA Analytical HPLC Plus system was used for this application. The system consisted of an isocratic AZURA P 6.1L pump, an AZURA AS 6.1L auto-sampler, an AZURA CT 2.1 column thermostat and a RF 20 Axs fluorescence detector in combination with CBM 20 A under the Chromeleon™ software. The isocratic method [6] was applied for 25 minutes at a flow

rate of 0.65 mL/min with a mixture of methanol and 3 mM phosphoric acid in a ratio 65:35 (v/v). The column temperature was set to 25 °C. The substances were measured with an excitation at 274 nm and emission at 456 nm. The used column in a dimension 150 x 4 mm ID with precolumn was filled with LiChrospher 100-5 RP 18 silica.

CONCLUSION

It was possible to identify and quantify ZON and its metabolites with the described isocratic method. Using a fluorescence detector for enhanced sensitivity allows measurements of small amounts of mycotoxins even in a complex sample matrix. This application can be used for quality control to make sure the set limit values according to Commission Regulation (EC) No 1881/2006 [7] will be maintained.

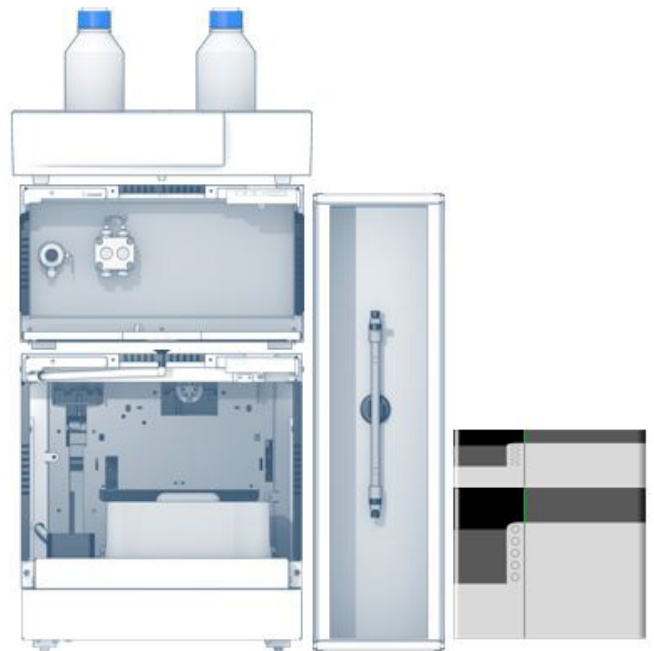

REFERENCES

- [1] W. Mücke, Ch. Lemmen, Schimmelpilze. Vorkommen, Gesundheitsgefahren, Schutzmaßnahme n. Ecomed Verlag, Landsberg am Lech, 2004
- [2] A. Zinedine, J.M. Sorianoet et al., Food and Chemical Toxicology, 2007, 45, 1-18
- [3] M. Weidenbörner, Encyclopedia of Food Mycotoxins, Springer, Berlin, 2001
- [4] Naresh Magan; Monica Olsen (2004). Mycotoxins in Food: Detection and Control. Woodhead Publishing. pp. 356-. ISBN 978-1-85573-733-4.
- [5] G. S. Eriksen (1998). Fusarium Toxins in Cereals: A Risk Assessment. Nordic Council of Ministers. pp. 61-. ISBN 978-92-893-0149-7.
- [6] Dr. Marina Müller, Leibniz-Zentrum für Agrarlandschaftsforschung (ZALF) e.V.
- [7] <http://eur-lex.europa.eu/legal-content/EN/TXT/PDF/?uri=CELEX:32006R1881&from=DE>

ADDITIONAL MATERIALS AND METHODS

Tab. A1 Method parameters

Eluent A	Methanol:3 mM phosphoric acid 65:35 (v/v)		
Eluent B	Methanol		
Gradient	Volume [mL]	% A	% B
	0.0	100	0
	13.0	100	0
	13.5	65	35
	18.0	65	35
	18.5	100	0
	25.0	100	0
Flow rate	0.65 mL/min	System pressure	ca. 120 bar
Column temperature	25 °C	Run time	25 min
Injection volume	2-20 µL	Injection mode	Partial loop
Detection wavelength	Ex 274 nm / Em 456 nm	Data rate	100 Hz
		Time constant	0.01 s

Tab. A2 System configuration

Instrument	Description	Article No.
Pump	AZURA P6.1L, isocratic	APH30EA
Autosampler	AZURA AS 6.1L	AAA00AA
Detector	RF 20Axs with CBM-20A	A59201
Thermostat	AZURA CT 2.1	A05852
Column	LiChrospher 100-5 RP 18, Vertex Plus 150 x 4 mm ID with precolumn	15WE189LSJ
Software	Chromeleon 7.2	

RELATED KNAUER APPLICATIONS

[VFD0159](#) - *Alternaria alternata* - determination of main metabolites

[VFD0152](#) - Determination of Aflatoxin in milk

Alternaria alternata - determination of main metabolites

Juliane Böttcher, Marina Müller¹, Kate Monks; applications@knauer.net
KNAUER Wissenschaftliche Geräte GmbH, Hegauer Weg 38, 14163 Berlin; www.knauer.net
¹Leibniz-Zentrum für Agrarlandschaftsforschung e.V., Müncheberg, Germany



SUMMARY

Alternaria toxins represent a possible health-endangering group of mycotoxins produced mainly by the Alternaria species. These are a widespread group of fungi contaminating mainly fruits and vegetables, but also other crop plants, during growth as well as storage. The most important mycotoxin-producing species is Alternaria alternata which occurs mainly on cereals and seeds [1].

INTRODUCTION

Even though Alternaria toxins are normally associated with fruits and vegetables that are visibly infected by Alternaria species, they have also been found in cereals, such as wheat, rye, sorghum, rice, and even tobacco. Alternaria toxins have been shown to exhibit both acute and chronic effects and therefore represent a threat to animal and human health. The most studied mycotoxin in the group of toxins produced by the species Alternaria is tenuazonic acid. Its main function is

the inhibition of protein synthesis and results in anti-tumor, antiviral and antibacterial activity. Most of the other Alternaria toxins show cytotoxic activity in mammals, some of them are mutagenic like the altertoxins, while others are toxic to the unborn [1]. This application focusses on the determination of alternariol (AOH), alternariol monomethyl ether (AME), altenuene (ALT) and tenuazonic acid (TeA).



Alternaria alternata – determination of main metabolites

RESULTS

All samples and standards were provided from the Leibniz-Zentrum für Agrarlandschaftsforschung (ZALF) e.V. [2]. First a calibration was made using the standard ZALF 5 with five different injection volumes. AOH was calibrated in a range from 0.5 ng up to 5.0 ng (absolute), ALT and AME from 1 ng up to 10 ng (absolute) and TeA from 2ng up to 20 ng (absolute). AOH, ALT and AME were detected with a fluorescence detector. TeA was determined using a UV detector. **Tab 1** gives a short summary of the retention times of the substances and achieved correlation coefficients of calibration. As sample an extracted nutrient

solution of an *Alternaria* strain was used. The extract was divided into two fractions. One for the TeA determination (ZALF 7, dilution 1:20) and one for the other metabolites (ZALF 6, without dilution). **Fig 1** shows an overlay of the fluorescence traces of the standard ZALF 5 and sample ZALF 6. For ALT, a concentration of 1.18 ng/μL was calculated, for AOH 2.74 ng/μL and 0.36 ng/μL for AME. **Fig 2** Shows the UV traces of standard ZALF 5 and sample ZALF 7 for determination of TeA. In the second fraction, a value of 3.44 ng/μL TeA was calculated.

Peak	Substance	Retention time	Correlation coefficient
1	ALT	4.063 min	0.99872
2	AOH	5.698 min	0.99853
3	TeA	8.424 min	0.99917
4	AME	10.664 min	0.99889

Tab. 1 Retention times and correlation coefficients of altenuene, alternariol, alternariol monomethyl ether and tenuazonic acid calibration

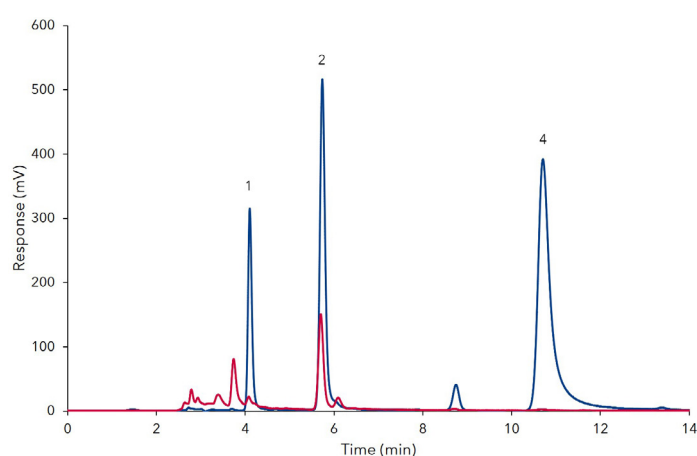

Fig. 1 Overlay of standard ZALF 5 (blue) and sample ZALF 6 (red), fluorescence detection, 1) ALT, 2) AOH, 3) TeA, 4) AME

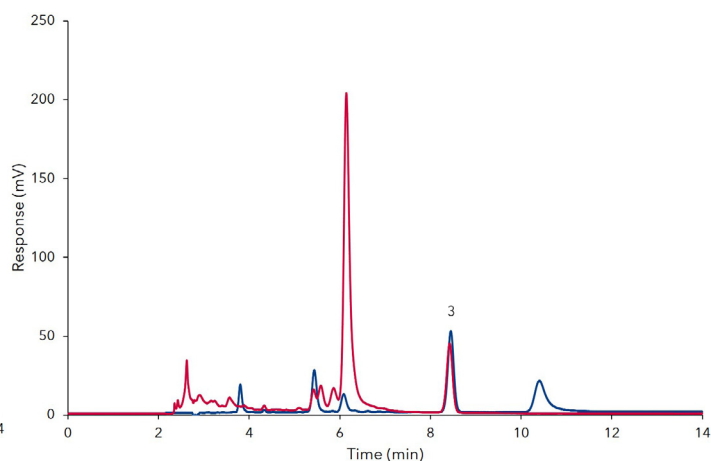

Fig. 2 Overlay of standard ZALF 5 (blue) and sample ZALF 7 (red), UV-detection, 3) TeA

MATERIALS AND METHODS

An AZURA® Analytical HPLC Plus system was used for this application. The system consisted of an isocratic AZURA P 6.1L pump, an AZURA AS 6.1L autosampler, an AZURA DAD 6.1L, an AZURA CT 2.1 column thermostat and a RF 20 Axs fluorescence detector in combination with CBM 20 A under the Chromeleon™ software. The isocratic method [2] was applied for 30 minutes at a flow rate of 1 mL/min with a mixture of methanol and water in a ratio 70:30 (v/v). Furthermore 300 mg/mL zinc sulfate were added to the mobile phase. The column temperature was set to 30 °C. The substances were measured with an excitation at 253 nm and emission at 415 nm. The UV detector was set 280 nm. The used column, in a dimension 250 x 4.6 mm ID with precolumn, was filled with Pronosil Hypersorb 120-5 ODS silica.

REFERENCES

- [1] <https://www.romerlabs.com/en/knowledge-center/knowledge-library/articles/news/alternaria-toxins/>
- [2] Dr. Marina Müller, Leibniz-Zentrum für Agrarlandschaftsforschung (ZALF) e.V.
- [3] <http://www.micotoxinas.com.br/altertoxins.htm>

CONCLUSION

It was possible to identify and quantify all *Alternaria alternata* metabolites with the described isocratic method. Using a fluorescence detector for enhanced sensitivity allows measurements of small amounts of mycotoxins even in a complex sample matrix. There are currently no statutory or guideline limits set for *Alternaria* mycotoxins because surveys to date have shown that their natural occurrence in foods is low and the possibility for human exposure is limited. The need for regulation is kept under review as new information becomes available [3].

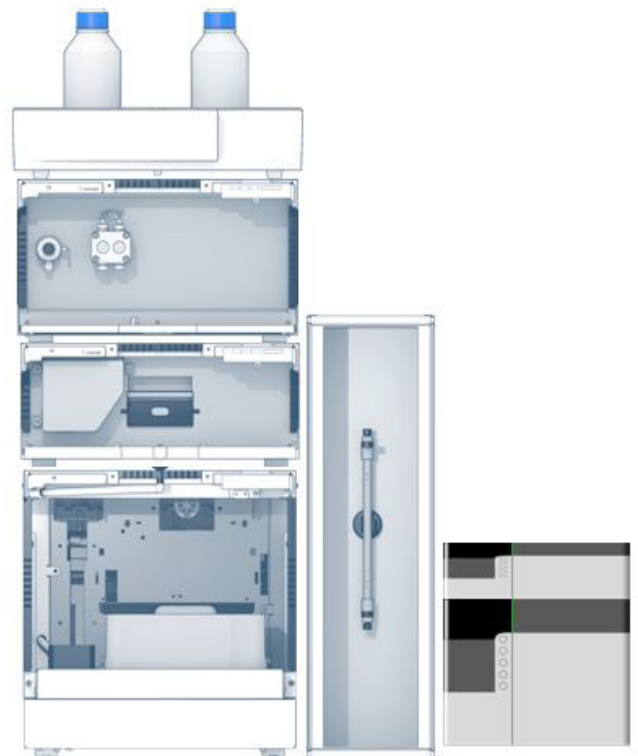

ADDITIONAL MATERIALS AND METHODS

Tab. A1 Method parameters

Eluent A	Methanol:Water 70:30 (v/v) with 300 mg/L ZnSO ₄ x 7 H ₂ O		
Eluent B	Methanol		
Gradient	Volume [mL]	% A	% B
	0.0	100	0
	14.0	100	0
	14.5	50	50
	21.0	50	50
	21.5	100	0
	30.0	100	0
Flow rate	1 mL/min	System pressure	ca. 160 bar
Column temperature	30 °C	Run time	30 min
Injection volume	1-10 µL	Injection mode	Partial loop
Detection UV	280 nm	Data rate	50 Hz
		Time constant	0.02 s
Detection FLD	Ex 253 nm / Em 415 nm	Data rate	100 Hz
		Time constant	0.01 s

Tab. A2 System configuration

Instrument	Description	Article No.
Pump	AZURA P6.1L, isocratic	APH30EA
Autosampler	AZURA AS 6.1L	AAA00AA
Detector	RF 20Axs with CBM-20A	A59201
Detector	AZURA DAD 6.1L	ADC11
Flow cell	LightGuide 50 mm, 6 µL	AMD59XA
Thermostat	AZURA CT 2.1	A05852
Column	Prontosil Hypersorb 120-5 ODS, VertexPlus Column 250 x 4.6 mm ID with precolumn	25VF180PYJ
Software	Chromeleon 7.2	

RELATED KNAUER APPLICATIONS

[VFD0158](#) - Zearalenone and its major metabolites - a simple isocratic method

[VFD0152](#) - Determination of Aflatoxin in milk

Determination of sugars and natural sugar substitutes in different matrices

Juliane Böttcher, Hagen Schlicke, Kate Monks; applications@knauer.net
KNAUER Wissenschaftliche Geräte GmbH, Hegauer Weg 38, 14163 Berlin; www.knauer.net



SUMMARY

Nowadays sugar substitutes are used in many products, not only for diabetic purposes but to make products more attractive for customers. Furthermore, people are interested in a healthier lifestyle which includes consuming less sugar. Therefore, a quality control of sugar and sugar substitutes in food and beverages needs to be compulsory, to assure the correct composition of ingredients.

INTRODUCTION

Sweet taste is favored by human beings. People instinctively desire the pleasure of sweetness, which resulted in a preference for sweet foods and beverages [1]. But sugar is rich in calories and that is why a lot of people are switching to light products containing sugar substitutes. These products contain less calories and are often obtained from natural crude materials. e.g. wood fibers of the birch. This application will

focus on the determination of commonly used sugars and natural sugar substitutes. Sucralose (E 955) is a high-intensity sweetener, about 600 times higher than saccharose. Mannitol (E 421) and sorbitol (E 420) have about half the intensity of saccharose and xylitol (E 967) has a quite equal intensity as commonly used sugar [2].



Determination of sugars and natural sugar substitutes in different matrices

RESULTS

A mixed standard of saccharose, sucralose, glucose, fructose, mannitol, xylitol, and sorbitol was used for calibration in a range from 0.25 mg/mL up to 2.0 mg/mL. Five different samples of caffeinated soft drinks as well as one sample of chewing gum and one sample of tooth paste were analyzed. Various compositions and contents of the analytes in the samples were determined (Tab A1, additional results).

Fig 1 shows a chromatogram of sample 5 compared to the standard mix. It reveals that this sample contains saccharose, glucose, and fructose exclusively. The analyzed chewing gum and tooth paste contain only mannitol, xylitol, and sorbitol. Additional peaks were observed in both chromatograms but are not related to the substances in the standard mix (Fig 2 & 3).

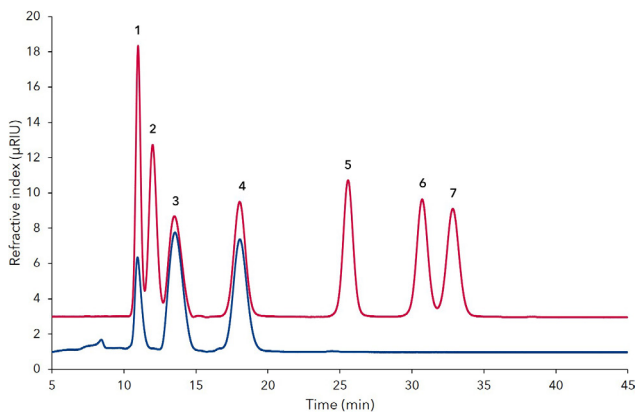

Fig.1 Overlay of mixed standard (red) and Guarana soft drink with sugar (dilution 1:30, blue), 1) saccharose, 2) sucralose, 3) glucose, 4) fructose, 5) mannitol, 6) xylitol, 7) sorbitol

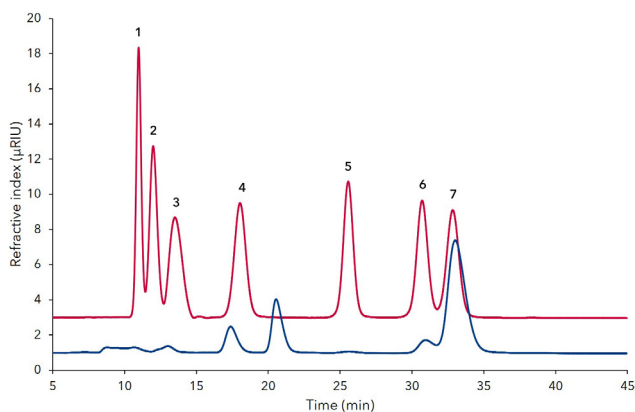

Fig.2 Overlay of mixed standard (red) and extracted tooth paste (blue), 1) saccharose, 2) sucralose, 3) glucose, 4) fructose, 5) mannitol, 6) xylitol, 7) sorbitol

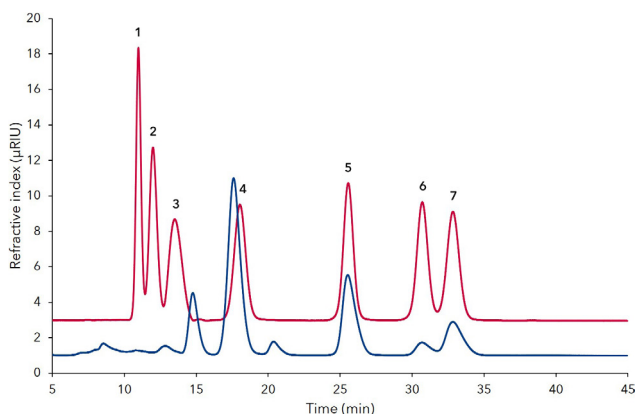

Fig.3 Overlay of mixed standard (red) and extracted chewing gum (blue), 1) saccharose, 2) sucralose, 3) glucose, 4) fructose, 5) mannitol, 6) xylitol, 7) sorbitol

MATERIALS AND METHODS

The AZURA® dedicated system for sugar analytics with an additional autosampler was used for this application. The system consisted of an isocratic AZURA P 6. 1L pump, an AZURA autosampler AS 6.1L, an AZURA CT 2.1 column thermostat, an AZURA RID 2.1L refractive index detector and an Eurokat Ca column in a dimension 300 x 8 mm ID with precolumn 30 x 8 mm ID filled with the same material. Eurokat Ca is a sulfonated cross-linked styrene-divinylbenzene copolymer. The isocratic method ran 45 minutes at a flow rate of 0.5 mL/min with 100 % aqueous eluent. The column thermostat was set to 60 °C and the data rate of the detector to 20 Hz. 20 µL of samples and standards were injected.

REFERENCES

- [1] <https://www.ncbi.nlm.nih.gov/pmc/articles/PMC3098376/>
- [2] <https://www.bzfe.de/inhalt/kennzeichnung-von-zusatzstoffen-1881.html>

CONCLUSION

The presence of natural sugar substitutes besides sugars in the same sample matrix is not prevalent but quite feasible. It can be seen, that the caffeinated soft drinks only contained sugar and no sugar substitutes. As expected the soft drinks which were declared to be "light" had no measurable amount of sugars. The extracted tooth paste and chewing gum were specified to be sugar-free but contain sugar substitutes. The detection of mannitol, xylitol or sorbitol was as expected. With the described method it is possible to identify the most commonly used sugars and natural sugar substitutes in one run. With little effort in sample preparation it is even contingent to determine these substances from solid samples such as chewing gum or tooth paste.

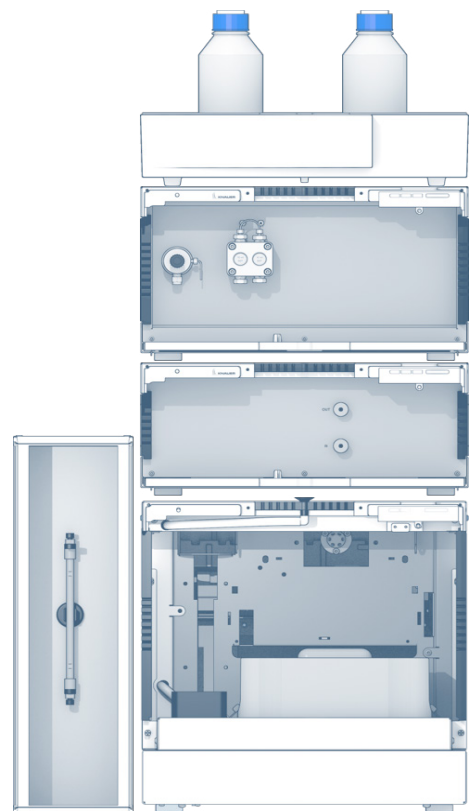

ADDITIONAL RESULTS

Tab. A1 Results of sample measurements (n.d. = not detectable)

Peak	Substance	Sample 1 (with sugar) in mg/mL	Sample 2 (light) in mg/mL	Sample 3 (light) in mg/mL	Sample 4 (Bio, with sugar) in mg/mL	Sample 5 (Guarana with sugar) in mg/mL	Sample 6 (chewing gum) in g/100 g	Sample 7 (tooth paste) in g/100 g
1	Saccharose	47.84	n.d.	n.d.	n.d.	8.54	n.d.	n.d.
2	Sucralose	n.d.	n.d.	n.d.	n.d.	n.d.	n.d.	n.d.
3	Glucose	17.12	n.d.	n.d.	37.58	30.60	n.d.	n.d.
4	Fructose	15.60	n.d.	n.d.	34.82	26.52	n.d.	n.d.
5	Mannitol	n.d.	n.d.	n.d.	n.d.	n.d.	10.98	0.23
6	Xylitol	n.d.	n.d.	n.d.	n.d.	n.d.	5.84	2.11
7	Sorbitol	n.d.	n.d.	n.d.	n.d.	n.d.	5.84	19.71

ADDITIONAL MATERIALS AND METHODS

Tab. A2 Method parameters

Eluent	Water		
Gradient	isocratic		
Flow rate	0.5 mL/min	System pressure	ca. 35 bar
Column temperature	60 °C	Run time	45 min
Injection volume	20 µL	Injection mode	Full loop
Detection	RI	Data rate	20 Hz
		Time constant	0.05 s

Tab. A3 System configuration

Instrument	Description	Article No.
Pump	AZURA P6.1L, isocratic	APH30EA
Autosampler	AZURA AS 6.1L	AAA00AA
Detector	AZURA RID 2.1L	ADD31
Thermostat	AZURA CT 2.1	A05852
Column	Vertex Plus Column, 300 x 8 mm, Eurokat Ca, 10 µm Vertex Plus Column, 30 x 8 mm, Eurokat Ca, 10 µm	30GX360EKN 03GX360EKN
Software	ClarityChrom 7.2	A1670-11



Dedicated AZURA® Sugar Analytical System

RELATED KNAUER APPLICATIONS

[VFD0161](#) - Determination of sugars in honey using HILIC separation and RI detection

[VFD0155](#) - Semi preparative xylitol purification with dedicated sugar purification system

[VFD0150](#) - Alternative xylitol extraction via hplc purification from fermented biomass

[VSP0013](#) - Simplified scale up for sugars with the AZURA RID 2.1L extended dynamic range option

Determination of sugars in honey using HILIC separation and RI detection

Hagen Schlicke, Kate Monks; applications@knauer.net
KNAUER Wissenschaftliche Geräte GmbH, Hegauer Weg 38, 14163 Berlin; www.knauer.net



SUMMARY

Honey is one of the most popular natural foods and the consumption has grown in the last few decades. Hydrophilic-interaction chromatography was used for the separation of mono- and disaccharides to distinguish between honey and honey substitute products. The dedicated AZURA® Sugar Analytical System with autosampler upgrade is perfectly suitable for this application.

INTRODUCTION

There are well over 50 different kinds of honey on the market, which differ in consistency, color, and taste. In Germany, the honey ordinance differentiates honey according to the origin, type of extraction, the form of supply or the intended use. Natural bee honey consists of approx. 39 % fructose and approx. 34 % glucose. [1] For example, blossom honey (Blütenhonig) must contain at least 60 % fructose and glucose [2]. In addition, small amounts of sucrose or maltose can be detected [1]. Internationally, products containing

more than 5 % sucrose or maltose must no longer be labeled as „pure“ honey [3]. The Association of Official Analytical Chemist (AOAC) designed a method for the analysis of sucrose, fructose, and glucose in honey (AOAC 977.20). Based on this method, we used an Eurospher II NH2 column for hydrophilic-interaction chromatography (HILIC). Two different commercially available honeys and two substitutes were analyzed to illustrate the differences between these products.



Determination of sugars in honey using HILIC separation and RI detection

RESULTS

The carbohydrates fructose, glucose, sucrose, and maltose were separated in 12 min with an isocratic method (Fig 1). All sugars could be quantified in a range of mg per 100 g standard sample. Thereby the lowest concentration measured in the standard mix used for the calibration was 0.39 mg/mL (Fig A1). All four sugars followed a linear calibration fit and had R² coefficients >0.999 (n=6, data not shown). The composition of the sugars in the examined samples differed greatly between the honey and the substitute products (Fig 2). The agave nectar had a much

higher content of fructose whereas honey substitute had only 1.24 g fructose per 100 g sample. The content of maltose was greatly increased in the honey substitute compared to the honey and the agave nectar samples. The two honey samples each contained more fructose than glucose. The total sugar content of bee honey and blossom honey was around 77 % and 74 %, respectively. No detectable amounts of sucrose were found in bee honey and agave nectar which additionally contained no maltose (Tab. 1).

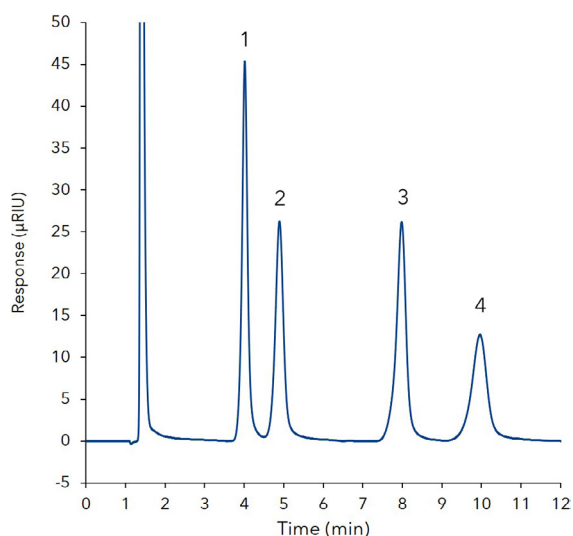

Fig. 1 Overlay of 12 replicates of the 12.5 mg/mL sugar standard containing 1) fructose, 2) glucose, 3) sucrose, 4) maltose

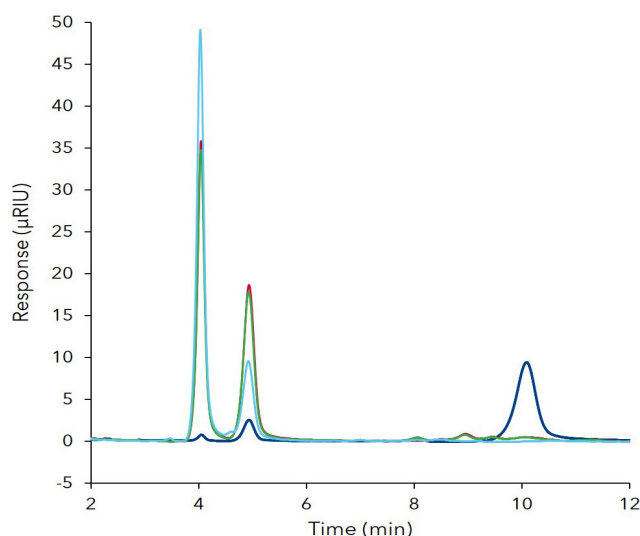

Fig. 2 Overlaid chromatograms of two honey and two honey substitute samples; blue - honey substitute, red - bee honey, green - blossom honey, light blue - agave nectar

Tab. 1 Quantitative results of two honeys and two honey substitutes

Sample	Fructose (g/100 g)	Glucose (g/100 g)	Sucrose (g/100 g)	Maltose (g/100 g)	Sugar content (%)
Honey substitute	1.24 ±0.04	5.18 ±0.21	1.17 ±0.07	35.15 ±0.73	42.74
Bee honey	39.09 ±0.13	35.32 ±0.67	0.00 ±0.00	2.98 ±0.22	77.39
Blossom honey	37.50 ±0.15	33.27 ±0.56	1.12 ±0.05	2.37 ±0.30	74.27
Agave nectar	53.98 ±0.12	18.98 ±0.73	0.00 ±0.00	0.00 ±0.00	72.96

MATERIALS AND METHODS

The AZURA® dedicated system for sugar analytics with an additional autosampler was used for this application. The system consisted of an isocratic AZURA P 6.1L pump, an AZURA AS 6.1L autosampler, an AZURA CT 2.1 column thermostat, an AZURA RID 2.1L refractive index detector, and an Eurospher II 100-3 NH2 150 x 4 mm column with pre-column. The isocratic method run for 12 min at a flow rate of 1.2 mL/min with 80 % acetonitrile used as eluent. The column thermostat was set to 35 °C, the data rate of the detector was set to 20 Hz, and 5 µL of sample and standards were injected. The four standards were first dissolved in water 1:40 (w/v), then mixed 1:1:1:1 (v/v/v/v), filtered (0.45 µm) and finally diluted 1:1 (v/v) with acetonitrile to achieve a 12.5 mg/mL stock solution. The samples were dissolved in water 1:20 (w/v), filtered (0.45 µm), and diluted 1:1 (v/v) with acetonitrile before injection.

CONCLUSION

The honey samples contained more than 60% fructose and glucose, as expected. The ratio of fructose and glucose was also typical of honey. The more glucose a honey has, the faster it tends to crystallize. The examined honey substitute and agave nectar showed a different kind of sugar pattern. The high maltose content indicates that honey substitute is not a natural product such as honey. Natural honey normally contains high concentrations of glucose and fructose and, in proportion, substantially less maltose. The data demonstrated the effective chromatographic separation of fructose, glucose, sucrose, and maltose using the AZURA dedicated system and an excellent linearity and retention time repeatability. In addition to the determination of sugars this application can also be used to differentiate between natural products such as honey and possible substitutes of the food industry.

REFERENCES

- [1] AID Zucker, Sirupe, Honig, Zuckeraustauschstoffe und Süßstoffe (Nr. 1157)
- [2] Honigverordnung vom 16. Januar 2004 (BGBl I S. 92)
- [3] Codex Alimentarius Commission, 2001; GB18796-2005, 2005

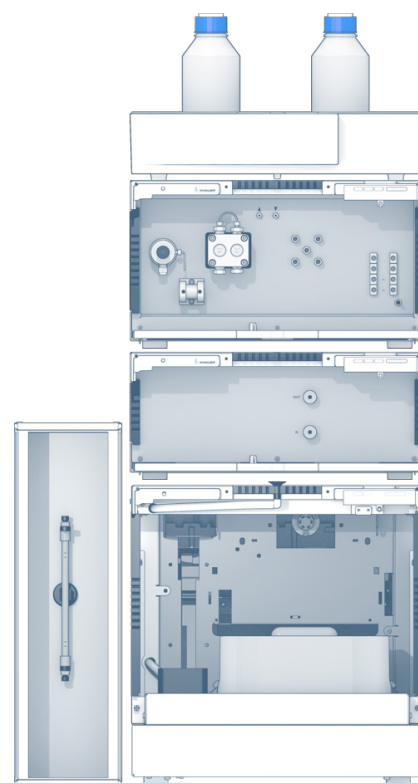

ADDITIONAL RESULTS

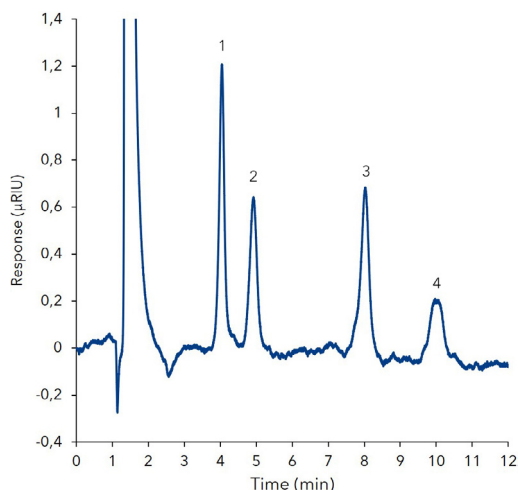

Fig. A1 Chromatogram of the 0.39 mg/mL sugar standard; 1) fructose, 2) glucose, 3) sucrose, 4) maltose

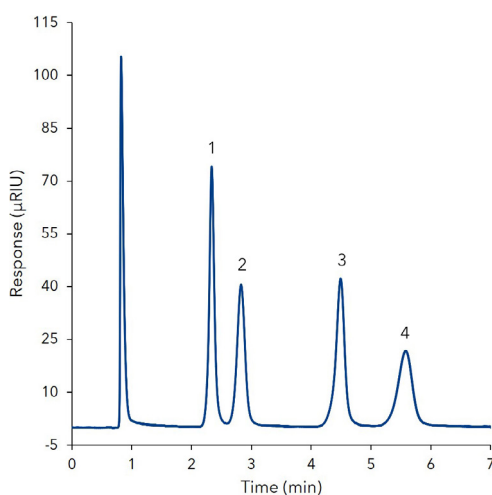

Fig. A2 Overlaid chromatograms of sugar standard. 1) fructose, 2) glucose, 3) sucrose, 4) maltose; Increasing the flow rate to 2 mL/min reduces the run time to 7 min. The overlay of the 6 runs shows that the method still has a high reproducibility. However, it should be noted that the lifetime of the column is shortened under these conditions and a regular calibration is recommended

ADDITIONAL MATERIALS AND METHODS

Tab. A1 Method parameters

Eluent	80% Acetonitrile gradient grade		
Gradient	isocratic		
Flow rate	1.2 mL/min	Run time	12 min
Column temperature	35 °C	Injection mode	Full loop
Injection volume	5 µL	Data rate	10 Hz
Detection	RI		

Tab. A2 System configuration & data

Instrument	Description	Article No.
Pump	AZURA® P6.1L, LPG	APH39EA
Autosampler	AZURA® AS 6.1L	AAA00AA
Detector	AZURA® RID 2.1L	ADD31
Column	Eurospher II 100-3 NH2 150 x 4 mm with precolumn	15WE190E2G
Thermostat	AZURA® CT 2.1	A05852
Software	ClarityChrom 7.2	A1670-11



Dedicated AZURA® Sugar Analytical System

RELATED KNAUER APPLICATIONS

[VFD0160](#) - Determination of sugars and natural sugar substitutes in different matrices

[VFD0155](#) - Semi preparative xylitol purification with dedicated sugar purification system

[VFD0150](#) - Alternative xylitol extraction via hplc purification from fermented biomass

[VSP0013](#) - Simplified scale up for sugars with the AZURA RID 2.1L extended dynamic range option

Separation of ascorbic acid and vitamin B complexes - essentially required nutrients



Stefan Weiz, Juliane Böttcher, Kate Monks; applications@knauer.net
KNAUER Wissenschaftliche Geräte GmbH, Hegauer Weg 38, 14163 Berlin; www.knauer.net

SUMMARY

Vitamins can be divided into fat-soluble and water-soluble vitamins. Water-soluble vitamins dissolve in water, which means these vitamins and nutrients dissolve quickly in the body. Examples for water soluble vitamins are vitamin C and the vitamin B complex: thiamin (B1), riboflavin (B2), niacin (B3), pantothenic acid (B5), vitamin B6, biotin (B7), folic acid (B9), cyanocobalamin (vitamin B12). In this work, eight water-soluble vitamins were separated and quantified in less than 10 min.

INTRODUCTION

Water-soluble vitamins are essential nutrients that an organism requires in limited amounts. All B-vitamins and C-vitamin are water-soluble vitamins. They are distributed in all watercontaining areas of the body, for example in blood or in cell interstices. Water-soluble vitamins are hardly stored in the body, only vitamin B12 can be stored in the liver. Therefore, a consistent intake is important, which can be achieved with one of the dietary supplement on the market. Vitamin B12 supplements are particularly important for individuals following a vegan diet. Qualitative and

quantitative analysis of vitamins in dietary supplements is a challenging task since vitamins are relatively unstable and vitamins are a mix of neutral, acidic and basic compounds. In the consecutively described results the separation of the vitamin B-complexes such as ascorbic acid, nicotinic acid, thiamine, pyridoxine, nicotinamide, cyanocobalamin (synthetic form of vitamin B12) and riboflavin is described. The method includes a wavelength switching step at 5.5 min to get the highest sensitivity for cyanocobalamin.

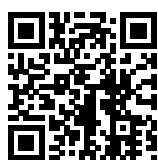

Separation of ascorbic acid and vitamin B complexes - essentially required nutrients

RESULTS

The absorption spectrum of cyanocobalamin shows a specific band at 360 nm, but at 220 nm the molar attenuation coefficient is higher (**Fig 1**). For the measurement of ascorbic acid and thiamine it is important, that the pH of the sample is set to a value of 3.0. It is recommended to use a 20 mmol potassium dihydrogenphosphate buffer adjusted to pH 3.0. In comparison, the eluent has a pH of 4.25. For ascorbic acid

the limit of quantification (LOQ, $S/N=10$) is 66 $\mu\text{g/L}$, for nicotinic acid 107 $\mu\text{g/L}$, for thiamine 1406 $\mu\text{g/L}$, for pyridoxine 2183 $\mu\text{g/L}$, for nicotinamide 162 $\mu\text{g/L}$, cyanocobalamin 145 $\mu\text{g/L}$ and for riboflavin 462 $\mu\text{g/L}$. **Fig 2** shows the chromatogram of a mixed vitamin B standard. The folic acid was not stable under the applied test conditions.

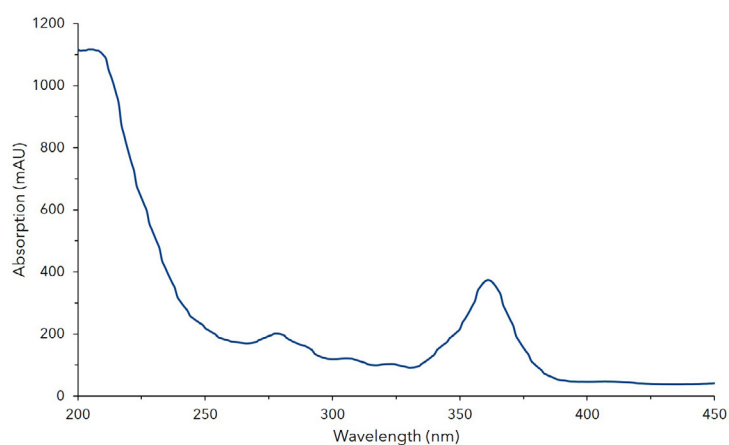

Fig. 1 Absorption spectrum of cyanocobalamin

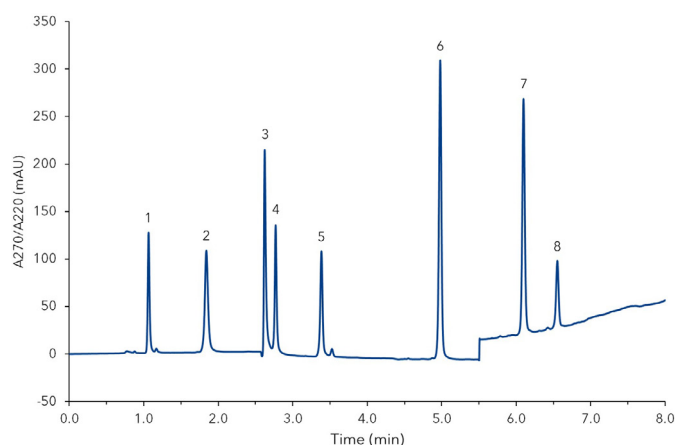

Fig. 2 Chromatogram of standard mix, 1) ascorbic acid, 2) nicotinic acid, 3) thiamine, 4) pyridoxine, 5) nicotinamide, 6) folic acid, 7) cyanocobalamin, 8) riboflavin

MATERIALS AND METHODS

An AZURA® UHPLC system was used for this application. The system consisted of an AZURA P 6.1L LPG pump, an AZURA AS 6.1L autosampler, an AZURA DAD 6.1L with a High Sensitivity LightGuide flow cell and an AZURA CT 2.1 column thermostat. Analysis was performed using the OpenLAB EZChrom Edition chromatography software. The samples were diluted in 20 mmol potassium dihydrogenphosphate buffer pH 3.0 and filtered over 0.45 µm pore size syringe filter. 10 µL of each sample was injected onto a 150 x 3 mm ID column, filled with Eurospher II 100-3 C18 A silica. The samples were separated at 30 °C at a flow rate of 1 mL/min with a linear gradient of 20 mmol potassium dihydrogenphosphate pH 4.25 adjusted with phosphoric acid (A) and acetonitrile (B) (0 - 30 % B in 8.5 min). At the beginning the detection wavelength was set to 270 nm and then switched to 220 nm at 5.5 min.

CONCLUSION

All components could be clearly be qualified and quantified. The wavelength switching increased the sensitivity of the method for the determination of cyanocobalamin (vitamin B12). This fast and sensitive method could be used for quality control of supplementary products.

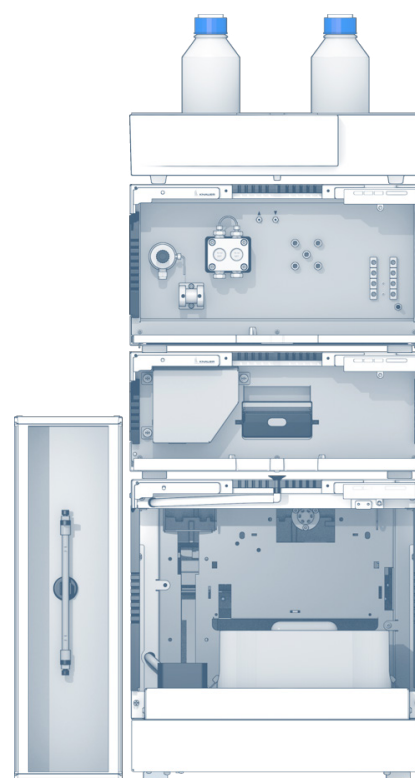

ADDITIONAL MATERIALS AND METHODS

Tab. A1 Method parameters

Eluent A	20 mmol potassium dihydrogenphosphate pH 4.25 (adjusted with phosphoric acid)		
Eluent B	Acetonitrile		
Gradient	Time (min)	% A	% B
	0.0	100	0
	0.5	100	0
	9.0	70	30
	12.0	70	30
	15.0	100	0
	20.0	100	0
Flow rate	1.0 mL/min	Run time	20 min
Column temperature	30°C	Injection mode	Full loop
Injection volume	10 µL	Data rate	20 Hz
		Time constant	0.05 sec
Detection wavelength switching			
Time (min)	nm		
0.0	270		
5.5	220		
19	270		

Tab. A2 System configuration

Instrument	Description	Article No.
Pump	AZURA® P6.1L, LPG 5 ml	APH34GA
Autosampler	AZURA® AS 6.1L	AAA10AA
Detector	AZURA® DAD 6.1L	ADC11
Flow cell	LightGuide 50mm, 6µL	AMDS9XA
Column	Eurospher II 100 3 C18 A , Vertex Plus Column 150 x 3 mm ID	15CE184E2G
Thermostat	AZURA® CT 2.1	A05852
Software	OpenLAB CDS EZChrom Edition	A2600-1

RELATED KNAUER APPLICATIONS

[VFD0172](#) - A D E K - Separation of fat-soluble vitamins using GPC/SE

[VFD0152](#) - Determination of Aflatoxin M1 in milk

[VFD0158](#) - Zearalenone and its major metabolites - a simple isocratic method

[VFD0159](#) - *Alternaria alternata* - determination of main metabolites

[VFD0160](#) - Determination of sugars and natural sugar substitutes in different matrices

[VFD0161](#) - Determination of sugars in honey using HILIC separation and RI detection

Natural or artificial? - Determination of vanillin in vanilla products and associated marker substances

Juliane Böttcher, Kate Monks - applications@knauer.net
KNAUER Wissenschaftliche Geräte GmbH,
Hegauer Weg 38, 14163 Berlin - www.knauer.net



SUMMARY

Vanillin is one of the most popular flavouring agents used in various food products, beverages, as well as in the pharma and perfume industry. With a high demand for the supply of vanilla pods and the continuous increase in price, artificial vanilla flavouring agents of synthetic origin are nowadays highly requested [1]. With this application the components of different vanilla products can be analysed. This is useful i.a. for the first screening concerning the authenticity.

INTRODUCTION

The high demand for vanillin far exceeds the supply from all sources covered by vanilla orchids which are the only source for the "real" vanilla flavour called "Bourbon vanilla". The high price of natural vanillin, compared with that of synthetic vanillin, and the poor availability are the reasons to produce vanillin via chemical synthesis since the 1870s. These processes use coniferin, guaiacol, or eugenol as a precursor [2]. Biotechnological processes like fermentation that use ferulic acid and rice bran as precursors of vanillin are relatively new. Biotechnologically produced vanillin is much more cost intensive than chemically synthesized vanillin. However, but the biotechnically produced products are allowed to use the designation "natural vanilla flavour". Chemically synthesized flavours must use the name "vanilla flavour". Some substances from the chemical or biotechnological manufacturing processes are unwanted in food products due to negative health effects. This makes an analytical

control indispensable. These molecules as well as the precursors used in the chemical synthesis are appropriate markers for the differentiation between synthetic vanilla flavour and Bourbon vanilla extract. While an exact statement about the origin of vanilla flavour is only possible after complex analytical methods like isotopic analysis, a first statement about the origin of vanilla flavour is already possible by screening for marker substances using HPLC methods. Therefore, in this work ethanolic extracts of vanillin containing samples are analysed to find marker substances as an association for the origin of the flavour.

Here, 4-hydroxybenzoic acid, vanillic acid, and 4-hydroxybenzaldehyde were analysed in addition to vanillin as typically occurring substances in Bourbon vanilla extract. Furthermore, guaiacol, coumarin, and eugenol were analysed as markers for synthetic vanilla flavour and unwanted precursors [3].

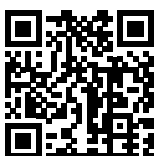

Natural or artificial? – Determination of vanillin in vanilla products and associated marker substances

RESULTS

A mixed standard of the seven compounds was used for calibration. The separation of the standard was achieved in under 4 minutes. All calibration curves showed a good linearity with $R^2 > 0.9999$. The detailed concentrations for each level are summarized in **Tab. 1**.

Fig. 1 shows exemplarily the separation of the mixed standard at level 3. Four different samples were extracted and analysed: vanilla bean, bourbon vanilla sugar, vanillin sugar, and vanilla baking aroma. All samples were extracted with ethanol. The detailed sample preparation is described in the additional results section (**Tab. A2**).

Fig. 2 shows the chromatogram of the extracted vanilla bean sample. The sample profile shows a high amount of vanillin and as expected the marker substances for Bourbon vanilla origin.

4-hydroxybenzoic acid, vanillic acid and 4-hydroxybenzaldehyde were also measured. The total amounts of vanilla compounds are summarized and calculated in **Tab. A1** (additional result section). **Tab. 1** shows the determined values for LOD ($S/N=3$) and LOQ ($S/N=10$) for this method. The chromatograms of the other analysed samples are also displayed in the additional section.

Tab. 1 Concentration of calibration levels and calculated LOD and LOQ

Substance	Level 1 mg/mL	Level 2 mg/mL	Level 3 mg/mL	Level 4 mg/mL	Level 5 mg/mL	LOD S/N=3 in µg/mL	LOQ S/N=10 in µg/mL
4-hydroxybenzoic acid	0.014	0.028	0.056	0.070	0.140	0.860	2.860
4-hydroxybenzaldehyde	0.010	0.020	0.040	0.050	0.100	0.180	0.610
Vanillin	0.015	0.030	0.060	0.075	0.150	0.350	1.150
Guaiacol	0.023	0.046	0.092	0.115	0.230	1.310	4.380
Coumarin	0.014	0.028	0.056	0.070	0.140	0.240	0.800
Eugenol	0.022	0.044	0.088	0.110	0.220	1.010	3.350
Vanillic acid	0.010	0.020	0.040	0.050	0.100	0.630	2.100

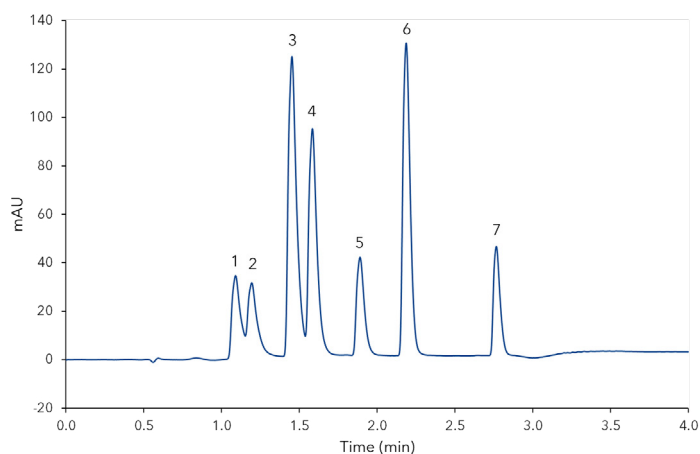

Fig. 1 Mixed standard at concentration Level 3, 1) 4-hydroxybenzoic acid, 2) vanillic acid, 3) 4-hydroxybenzaldehyde, 4) vanillin, 5) guaiacol, 6) coumarin, 7) eugenol

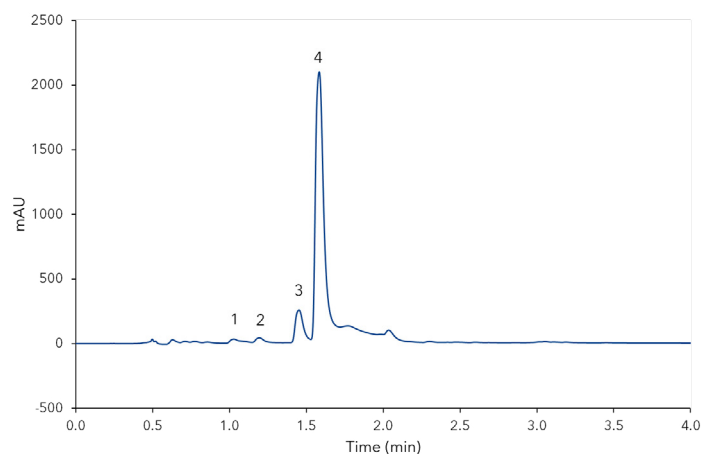
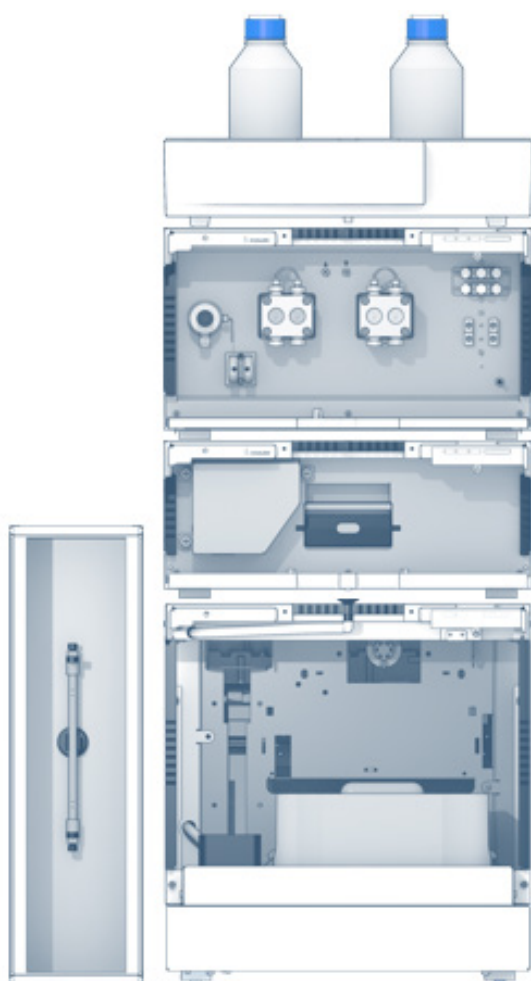

Fig. 2 Chromatogram of extracted vanilla bean, 1) 4-hydroxybenzoic acid, 2) vanillic acid, 3) 4-hydroxybenzaldehyde, 4) vanillin

MATERIALS AND METHOD

Here, the AZURA® UHPLC system was used which consisted of an AZURA P 6.1L HPG pump, an autosampler AZURA AS 6.1L, a column thermostat CT 2.1, and an AZURA MWD 2.1L. The flow was set to 0.5 mL/min at a temperature of 40 °C. 1µL of the samples and standards was injected. Detection took place at 280 nm. The mobile phase is a gradient composition of A: water with 0.05 % trifluoroacetic acid and B: acetonitrile with 0.1 % trifluoroacetic acid. The column was filled with Eurospher II 100-2 C18A silica in a dimension 100x2 mm ID.



CONCLUSION

According to the BLL guidelines for vanilla sugar and vanillin sugar from 2007 [4], vanilla sugar is a mixture of saccharose and crushed vanilla beans. Vanillin sugar, however, is a composition of saccharose and vanillin. Due to the calculated amounts in **Tab. A1**, the analysed Bourbon vanilla sugar contains vanillin as well as 4-hydroxybenzaldehyde, a marker for a natural vanilla flavour. The vanillin sugar on the other hand contains more vanillin and also a high amount of guaiacol which indicates its artificial/synthetic origin. The vanilla baking aroma contained the highest amount of vanillin but also residues of all other compounds. Since for the analysed aroma no declaration of composition is necessary, it could contain natural vanilla as well as synthetic aroma ingredients [5]. The shown UHPLC method allows a first and fast quality control of vanilla products regarding the marker substances for synthetic or natural based extracts. Besides the isotopic analysis there are characteristic numbers, also for HPLC analysis, that can be pulled to make a more sophisticated statement about the vanilla origin, but these were not considered in this application [6].

REFERENCES

- [1] Krishna Veni et al, J Adv Sci Res, 2013, 4(1): 48-51: Analysis of Vanillin In Food Products By High Performance Thin Layer Chromatography
- [2] Jagerdeo et al., Journal of AOAC International Vol. 83, No. 1, 2000 Liquid Chromatographic Determination of Vanillin and Related Aromatic Compounds
- [3] Authenticity of vanilla and vanilla extracts, Elke Anklam, Joint Research Centre European Commission, Environment Institute Food & Drug Unit, 1993, EUR 15561 EN
- [4] Richtlinie für Vanille-Zucker und Vanillin-Zucker (2007) ([link](#))
- [5] Vanille und Vanillearomen, Vanille - die Königin der Gewürze ([link](#))
- [6] Grundlagenpapier der Arbeitsgruppen „Aromastoffe“ und „Stabilisotopenanalytik“ in der Lebensmittelchemischen Gesellschaft zum Thema Herkunft und Authentizität von Vanillearomen ([link](#))

ADDITIONAL RESULTS

Tab. A1 Calculated amount of vanilla compounds (in mg/g)

Sample	4-hydroxybenzoic acid	Vanillic acid	4-hydroxybenzaldehyde	Vanillin	Guaiacol	Coumarin	Eugenol
Vanilla bean	0.07	0.104	0.169	3.129	0	0.009	0.007
Bourbon vanilla sugar	0	0	0.015	0.195	0.205	0.003	0.01
Vanillin sugar	0	0	0	8.257	8.704	0.006	0
Vanilla baking aroma	0.017	0.005	0.123	16.533	0	0.019	0.017

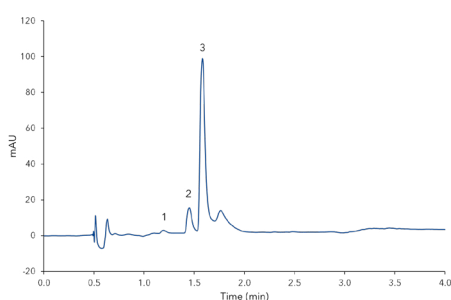

Fig. A1 Chromatogram of bourbon vanilla sugar, 1) vanillic acid, 2) 4-hydroxybenzaldehyde, 3) vanillin

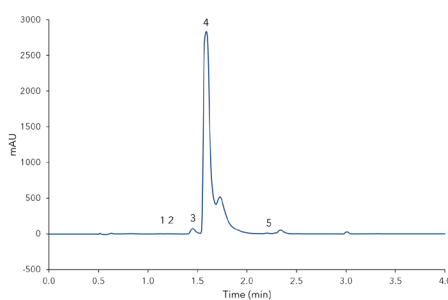

Fig. A2 Chromatogram of vanilla baking aroma, 1) 4-hydroxybenzoic acid, 2) vanillic acid, 3) 4-hydroxybenzaldehyde, 4) vanillin, 5) coumarin

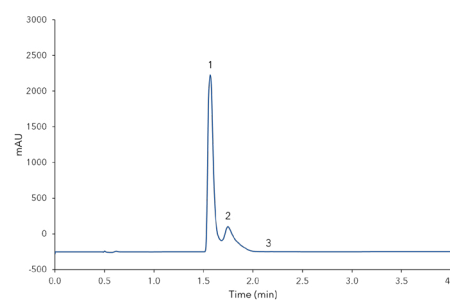

Fig. A3 Chromatogram of vanillin sugar, 1) vanillin, 2) guaiacol, 3) coumarin

ADDITIONAL MATERIALS AND METHODS

Tab. A2 Method parameters

Column temperature	40° C
Injection volume	1 µL
Injection mode	Partial loop
Detection wavelength	UV 250 nm
Data rate	100 Hz
Time constant	0.01 s

Tab. A4 Pump parameters

Eluent A	H ₂ O _{dd} + 0.05 % TFA		
Eluent B	Acetonitrile + 0.1 % TFA		
Flow rate	0.5 mL/min		
Pump program	Time [min]	% A	% B
	0.00	75	25
	0.60	65	35
	2.20	25	75
	2.30	0	100
	3.50	0	100
	3.52	75	25
	8.00	75	25

Tab. A3 Sample preparation

Vanilla bean	~2 g of crushed vanilla bean was extracted with 4 mL ethanol
Vanillin sugar	1 g of sugar is extracted with 6 mL ethanol
Bourbon vanilla sugar	1 g of sugar is extracted with 4 mL ethanol
Vanilla baking aroma	1 mL (~ 0.83 g) of baking aroma is extracted with 4 mL ethanol

All samples were filtered through a 0.45 µm syringe filter after extraction.

Tab. A5 System configuration

Instrument	Description	Article No.
Pump	AZURA P 6.1L HPG	APH35GA
Autosampler	AZURA AS 6.1L	AAA10AA
Detector	AZURA MWD 2.1L	ADB01
Flow cell	Standard KNAUER LightGuide UV Flow Cell Cartridge	AMC19XA
Thermostat	AZURA CT 2.1	A05852
Column	Eurospher II 100-2 C18A, 100 x 2 mm ID	10BE184E2F
Software	ClarityChrom 7.4.2 - Workstation autosampler control included	A1670
Software	ClarityChrom 7.4.2 - System suitability extension (SST)	A1677

RELATED KNAUER APPLICATIONS

[VFD0136N](#) - Comparison of compounds in Bourbon vanilla extract and vanilla flavor

[VFD0073J](#) - Determination of coumarin in cinnamon products

LC-FLD analysis of 4 PAHs in olive oil samples using AZURA® GPC Cleanup System



Federica Massari**, Juliane Boettcher*, Kate Monks*, Pietro Cotugno**, Carlo Zambonin**, applications@knauer.net

*KNAUER Wissenschaftliche Geräte GmbH, Hegauer Weg 38, 14163 Berlin; www.knauer.net

** Department of Chemistry, University of Bari "Aldo Moro", Via Orabona, 4, 70126 Bari, Italy.

SUMMARY

The aim of this work is to perform the cleanup of olive oil samples before HPLC analysis by means of the AZURA GPC Cleanup System. The GPC-LC-FLD method is very useful to identify and quantify Benzo(a)pyrene and the sum of four Polycyclic Aromatic Hydrocarbons, PAHs, in olive oils according to Commission Regulation (EU) No 835/2011.

INTRODUCTION

Polycyclic aromatic hydrocarbons (PAHs) are environmental pollutants, characterized by their hazardous carcinogenic and mutagenic potential [1]. PAHs are ubiquitous compounds, since they can be found not only in all different environmental media (such as air, soil, and water), but also in various foods we encounter in our everyday life [2]. Humans are exposed to PAHs by various pathways. While for smokers the contribution from smoking may be significant, for non-smokers the major route of exposure is the consumption of food, so the dietary intake of PAHs poses the potential health hazards to the public. Food can be

contaminated from environmental sources, industrial food processing and from certain home cooking practices. The presence of PAHs in vegetable oils is generally explained by the combination of many factors and processes including the drying process of the oil seeds (with the combustion of gases), contamination during solvent extraction, packaging material, soil burn [1]. Due to their demonstrated carcinogenic and mutagenic activity, they have been largely investigated. A great effort has been devoted to the improvement of the analytical method to determine such compounds in complex samples, such as food.



LC-FLD analysis of 4 PAHs in olive oil samples using AZURA® GPC Cleanup System

RESULTS

To validate the analytical method correlation coefficient R^2 , limit of detection and quantification were calculated. The limits of detection (LODs) and of quantification (LOQs) were calculated by the standard deviation of six calibration solutions at a concentration level equal to the lowest calibration level, an approach does not take into account the matrix effect, on the basis of Regulation (EU) No 836/2011. However they are lower than the limit values namely 2.0 $\mu\text{g}/\text{kg}$ and 10.0 $\mu\text{g}/\text{kg}$ for BaP and PAH4 respectively (Regulation (EU) No 835/2011). The precision of the method was investigated at 0.1 $\mu\text{g}/\text{L}$ (BaA, Chry, BaP), 0.2 $\mu\text{g}/\text{L}$ (BbF) by performing replicate measurements

($n=3$) for 3 days, to estimate the within-day and between-days precision, which was found always lower than 5 %. Recoveries were calculated by a spiked olive oil sample (sample 4, organic origin) at concentration levels of 3.3 $\mu\text{g}/\text{L}$ (BbF), 1.6 $\mu\text{g}/\text{L}$ (BaA, Chry, BaP). Good recoveries were obtained for 4 PAHs, according to Regulation (EU) No 836/2011 [5]. All these parameters are listed in (Tab A2 additional results). Fig 1 and Fig 2 show respectively LC-FLD chromatograms of a standard solution and of a spiked purified oil sample. Quantification results of LC-FLD analysis of the selected samples are reported in Tab. 1.

Tab. 1 Quantification results from LC-FLD analysis of four olive oil samples

Analyte	Cal range ($\mu\text{g}/\text{L}$)	R^2	LOD ($\mu\text{g}/\text{L}$)	LOQ ($\mu\text{g}/\text{L}$)	RSD %	% recovery mean
Benzo(a)anthracene	0.1 - 10.0	0.9994	0.01	0.04	2.98	100 \pm 3
Chrysene	0.1 - 10.0	0.9995	0.02	0.06	4.13	100 \pm 4
Benzo(b)fluoranthene	0.2 - 20.0	0.9995	0.04	0.13	3.15	60 \pm 5
Benzo(a)pyrene	0.1 - 10.0	0.9989	0.02	0.06	4.63	60 \pm 5

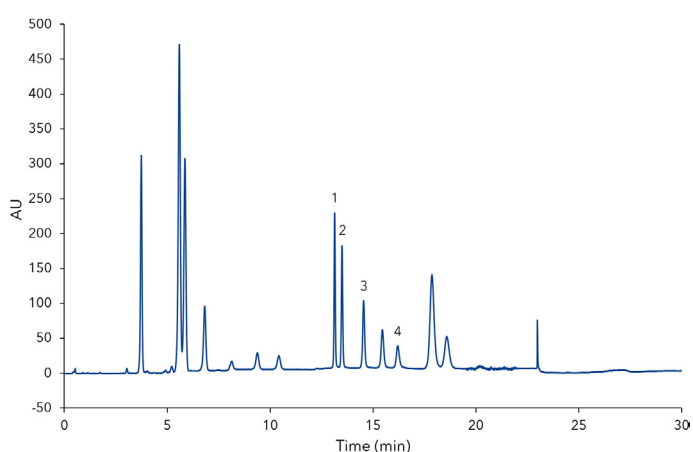

Fig. 1 LC-FLD chromatogram of a standard solution of PAHs at the concentration levels of 5 $\mu\text{g}/\text{L}$ (1) BaA, 2) Chry, 4) BaP) and 10 $\mu\text{g}/\text{L}$ (3) BbF), respectively

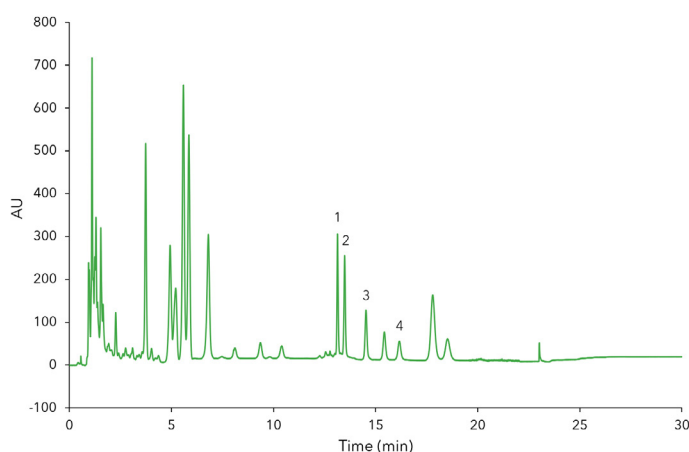

Fig. 2 LC-FLD chromatogram of a spiked and purified oil sample: 1) BaA; 2) Chry; 3) BbF; 4) BaP

REFERENCES

- [1] Vasudha Bansal, Ki-Hyun Kim. Environment International 84 (2015) 26-38
- [2] Moon, H.B., Kannan, K., Lee, S.J., Ok, G., 2006. Arch. Environ. Contam. Toxicol. 51, 494-502

MATERIALS AND METHODS

150 mg of each oil sample were diluted with the mobile phase for GPC, Cyclohexane:DCM, 70:30 (v/v), to a volume of 2 mL. Then the mixture was thoroughly mixed using an ultrasonic bath for few seconds. Filtration with a PTFE syringe filter with a pore size of 0.45 µm was necessary before GPC cleanup. After calibrating the system using GPC calibration mixture, the sample cleanup could be performed. 2 mL of each olive oil sample were loaded into the GPC loop with the following procedure: firstly the injection valve was set to load position and the column bypass valve to load position. Secondly, each loop was rinsed with GPC

mobile phase before sample loading and thereafter all tubings were emptied by injecting air with a syringe. Next, the sample was loaded through the injection port and the two sample loop valves were switched to the next position in order to close the loop. The procedure was repeated for each sample and finally the injection valve was set to inject position to start sequence running. Each purified sample is collected by switching of the fractionation valve automatically. After the cleanup, samples were concentrated under nitrogen stream, reconstituted in mobile phase for the HPLC analysis and fluorescence detection.

CONCLUSION

AZURA® GPC Cleanup system is a useful tool for a fast sample pre-treatment of olive oil samples before LC analysis with fluorescence detection. The GPC clean-up method represents a very important preliminary step for the determination of 4 PAHs recognized for their demonstrated carcinogenic and mutagenic activity. Benzo(a)pyrene was not present in all analyzed samples. Moreover, all analyzed samples show a PAHs content lower than that required from the Reg. 835/2011 as the sum of the four PAHs results to be always lower than 10.0 µg/kg.

REGULATIONS

The Scientific Panel on Contaminants in the Food Chain (CONTAM Panel) of EFSA adopted an opinion on Polycyclic Aromatic Hydrocarbons in Food suggesting that benzo(a)pyrene is not a suitable marker for the occurrence of polycyclic aromatic hydrocarbons in food and that a system of four specific substances (PAH4) or eight specific substances (PAH8) would be the most suitable indicator of PAHs in food. Then, Commission Regulation (EU) No 835/2011 of 19 August 2011 amending Regulation (EC) No 1881/2006 required that new maximum levels for the sum of four substances, PAH4 (Benzo(a)pyrene, BaP, Benzo(a)anthracene, BaA, Benzo(b)-fluoranthene, BbF and Chrysene, Chry) should be introduced, whilst maintaining a separate maximum level for benzo(a)pyrene [3, 4]. The maximum levels for Benzo(a)pyrene and PAH4 are respectively 2.0 µg/kg and 10.0 µg/kg in oils and fats (excluding cocoa butter and coconut oil) intended for direct human consumption or use as an ingredient in food. Commission Regulation (EU) No 836/2011 of 19 August 2011 amending Regulation (EC) No 333/2007 established the sampling method and analysis for the official control of the levels of lead, cadmium, mercury, inorganic tin, 3-MCPD and benzo(a)pyrene in foodstuffs [5].

[3] Commission Regulation (EC) No 1881/2006 of 19 December 2006 setting maximum levels for certain contaminants in foodstuffs.

[4] Commission Regulation (EU) No 835/2011 of 19 August 2011 amending Regulation (EC) No 1881/2006 as regards maximum levels for polycyclic aromatic hydrocarbons in foodstuffs.

[5] Commission Regulation (EU) No 836/2011 of 19 August 2011 amending Regulation (EC)

No 333/2007 laying down the methods of sampling and analysis for the official control of the levels of lead, cadmium, mercury, inorganic tin, 3-MCPD and benzo(a)pyrene in foodstuffs.

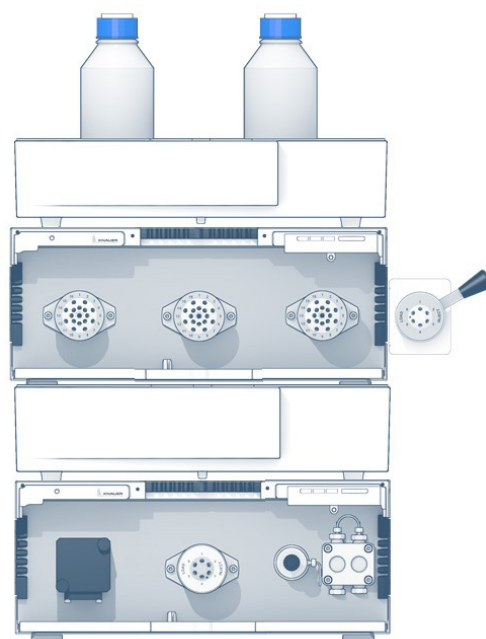

ADDITIONAL RESULTS

Tab. A1 Different analytical parameters for the analytical method according to Regulation (EU) No 836/2011

Parameter	Criterion
LOD	≤ 0.30 µg/kg for each of the four substances
LOQ	≤ 0.90 µg/kg for each of the four substances
Recovery	50 - 120 %

Tab. A2 R2, LOD and LOQ, RSD %, % recovery mean

Analyte	Concentration (µg/kg)			
	Sample 1	Sample 2	Sample 3	Sample 4
Benzo(a)anthracene	< LOD	2.7	< LOD	< LOD
Chrysene	4.3	6.1	2.3	1.3
Benzo(b)fluoranthene	< LOD	< LOD	< LOD	< LOD
Benzo(a)pyrene	< LOD	< LOD	< LOD	< LOD
PAH4	4.3	8.8	2.3	1.3

ADDITIONAL MATERIALS AND METHODS

Tab. A3 GPC Method parameters

Eluent			
Gradient	isocratic		
Flow rate	1 mL/min	System pressure	35 psi
Run temperature	RT	Run time	60 min
Injection volume	2 mL	Injection mode	Full loop
Detection wavelength	254 nm	Data rate	10 Hz
Collect time	18-48 min	Time constant	0.1 sec

Tab. A5 System configuration & data

Instrument	Description	Article No.
AZURA GPC Cleanup System		771101114
Pump	AZURA P 6.1L	APH35ED
Autosampler	AZURA AS 6.1L	AAA01AA
Detector	AZURA DAD 6.1L	ADC11
Detector	Fluorescence Detector RF-20 A	A59200
Thermostat	AZURA CT 2.1	A05852
Column (GPC)	Glass column 450 mm length x 10 mm ID. Bio-Beads S-X3 resin	
Column (HPLC)	Nucleosil 100-5 C18 PAH, 150 x 4 mm ID with precolumn	15DE420NSJ
Software (GPC)	Mobile Control Chrom with tablet	A9608
Software (HPLC)	ClarityChrom 7.4.1 - Workstation, autosampler control included	A1670

Tab. A4 HPLC Method parameters and detection settings

Eluent A	Water		
Eluent B	Acetonitrile		
Gradient	Time (min)	% A	% B
	0	40	60
	11	25	75
	12	0	100
	22	0	100
	22.02	40	60
	30	40	60
Flow rate	1.2 mL/min	System pressure	150 bar
Column temperature	20°C	Run time	30 min
Injection volume	10 µL	Injection mode	Partial loop
FLD Detection	Excitation and Emission wavelength settings		
Time	Ex. (nm)	Em. (nm)	
0	270	330	
5.0	270	330	
6.0	250	370	
8.0	330	430	
12.0	270	390	
13.90	370	460	
16.50	290	405	
19.50	246	503	
22.0	270	330	
	Data rate (Hz)	5	
	Time constant	0.1	
UV Detection	Detection (nm)	254	
	Data rate (Hz)	20	
	Time constant (s)	0.05	

RELATED KNAUER APPLICATIONS

[VFD0152](#) - GPC cleanup of olive oil samples

Oh so sweet - Quantification of steviol glycosides in stevia samples with RP-HPLC



Johannes Menke², Juliane Böttcher¹, Kate Monks¹; applications@knauer.net

¹KNAUER Wissenschaftliche Geräte GmbH, Hegauer Weg 38, 14163 Berlin; www.knauer.net

²Staatliche Technikerschule Berlin, Bochumer Str. 8B, 10555 Berlin

SUMMARY

Steviol glycosides are the main sweetening compounds in *Stevia rebaudiana* and can be used as natural sugar substitutes. This method provides a fast determination of six steviol glycosides using the AZURA® HPLC Plus System. With a fast separation under 10 min and an optimized gradient, the developed method is suitable for a fast quality control of stevia products. Furthermore, the robustness for this method was validated using DryLab simulation software.

INTRODUCTION

Steviol glycosides are the main sweetening compounds in *Stevia rebaudiana* which have a far higher sweetening power than normal sucrose or glucose. The sweetness is estimated to be about 400 times higher. Stevia additives have been approved by the EU since 2011 as sweeteners for beverages and food. Good quality Stevia formulates usually do not have the bitter aftertaste as often other sweeteners do. Furthermore, due to their chemical structure they have no known harmful effect on overweight individuals or patients suffering from diabetes, making them an ideal substitute for household sugars. [1] [2]

A method as been developed able to quantify and qualify six of the 12 to 14 steviol glycosides that can be found in stevia plants. The substances determined are rebaudioside A, stevioside, rebaudioside C, dulcoside A, rebaudioside B, and steviolbioside. The method was optimized in terms of temperature and gradient slope using DryLab simulation software. Two different stevia samples were analyzed. Firstly, a sample obtained from dried *Stevia rebaudiana* leaves and secondly a sample obtained from a commonly sold Stevia sweetener.

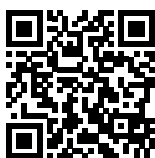

Oh so sweet – Quantification of steviol glycosides in Stevia samples with RP-HPLC

RESULTS

In **Fig 1** the separation of the mixed standard of six steviol glycosides used for calibration at a level of 0.1 mg/mL for each compound is depicted. The resolution of the critical pair of peaks, namely, rebaudioside A and stevioside was very good and both components were baseline separated. All determined steviol glycosides were baseline separated from each other. The results of the sample measurement are displayed in **Fig 2 and 3**. The quantification of the compounds was achieved with high accuracy and precision. As shown in **Tab A1** (additional results section), several of the calibrated compounds could be determined in both samples. According to the manufacturer of the stevia sweetener it should only contain

rebaudioside A with a mass percentage of 3 %. The measurement shows that this is clearly not the case. Rebaudioside A was determined to be the main component with about 2.4 %, but also stevioside, rebaudioside C, and rebaudioside B were measured. The calculated amounts of steviol glycosides in the analyzed samples are summarized in **Tab A1** (additional results section). Furthermore, 3D-data was recorded showing that no impurities eluted at the same time with the analytes. The recorded continuous spectrum from 200 to 700 nm shows only maxima at the wavelength of 210 nm ensuring clean separation. No trace of sample matrix can be seen.

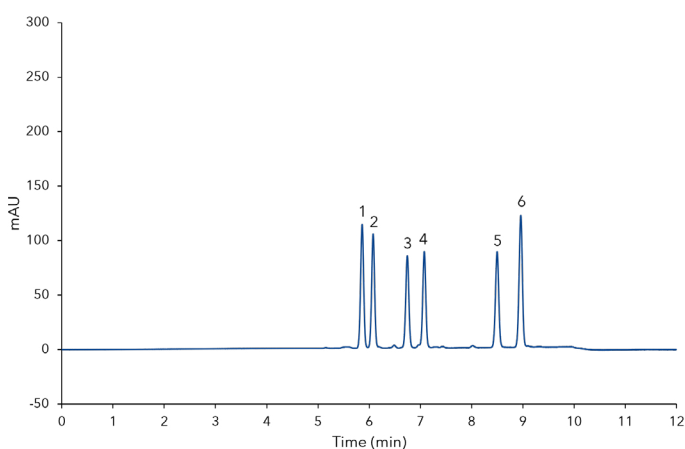

Fig. 1 Chromatogram of calibration standard at a concentration of 0.1 mg/mL; 1) rebaudioside A, 2) stevioside, 3) rebaudioside C, 4) dulcoside A, 5) rebaudioside B, 6) steviolbioside

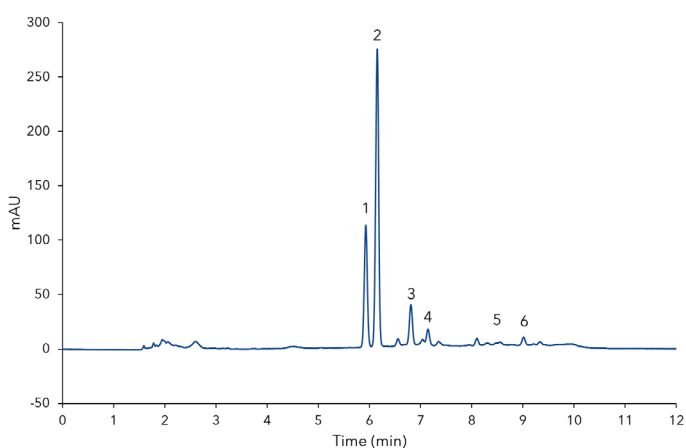
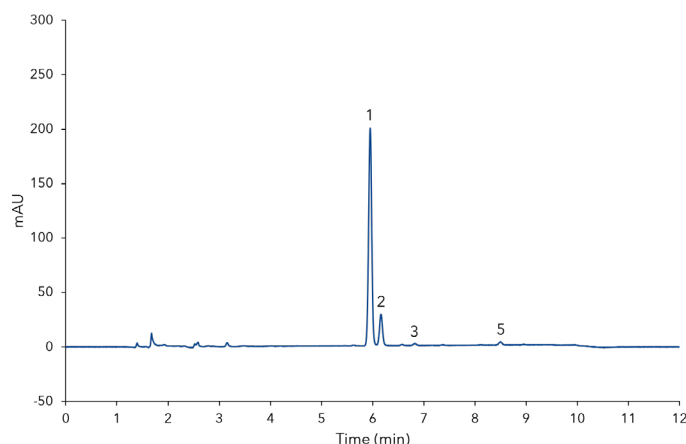

Fig. 2 Chromatogram of dried Stevia leaves sample after SPE purification; 1) rebaudioside A, 2) stevioside, 3) rebaudioside C, 4) dulcoside A, 5) rebaudioside B, 6) steviolbioside

Fig. 3 Chromatogram of Stevia sweetener sample; 1) rebaudioside A, 2) stevioside, 3) rebaudioside C, 4) dulcoside A, 5) rebaudioside B, 6) steviolbioside



MATERIALS AND METHODS

The determination of steviol glycosides was performed on a KNAUER AZURA HPLC Plus System equipped with an autosampler AZURA AS 6.1L, a binary high-pressure gradient pump AZURA P 6.1L with 10 mL pump head, an AZURA CT 2.1L column thermostat, and a diode array detector AZURA DAD 2.1L. The eluent was a composition of A: water and B: acetonitrile. A step gradient at a flow rate of 1.2 mL/min was used with a total run time of 12 minutes including equilibration time. The column temperature was set to 40 °C. Detection was carried out at 210 nm and additionally the spectrum was recorded in a range from 200 nm to 700 nm. The column used here had the dimensions 250 x 4.6 mm ID with precolumn was filled with Eurospher II 100-5 C18 silica. Injection volume was 20 µL for samples and standard solutions.

CONCLUSION

The quantification of the compounds was achieved with high accuracy and precision again showing the robustness of this method. This method provides a fast and robust analysis for food samples containing steviol glycosides with a runtime of only 12 min per sample. Furthermore, with the optimized gradient and column temperature a baseline separation of the otherwise similarly eluting rebaudioside A and stevioside is achievable. The SPE sample preparation will diminish the matrix of plant extracts to a very low level preventing disturbances during sample analysis, which results in lower detection limits.

REFERENCES

- [1] Steviolglycoside in Süßwaren Entwicklung und Validierung einer Analysenmethode mittels HPLC-UV. Teresa Brandes. Marion Raters and Reinhard Matissek. DLR. 2013 literature\steviolglycoside-in-suesswaren-dlr.pdf
- [2] Application Note - Fast online SPE purification of Stevia plant extracts. René Borstel. 2011 literature\vfd0093n_online_spe_of_steviol_glycosides.pdf
- [3] Reversed-Phase HPLC Analysis of Steviol Glycosides Isolated from Stevia rebaudiana Bertoni. Venkata Sai Prakash Chaturvedula and Julian Zamora. Food and Nutrition Sciences. 2014. 5. 1711-1716 literature\Stevia_RP.pdf

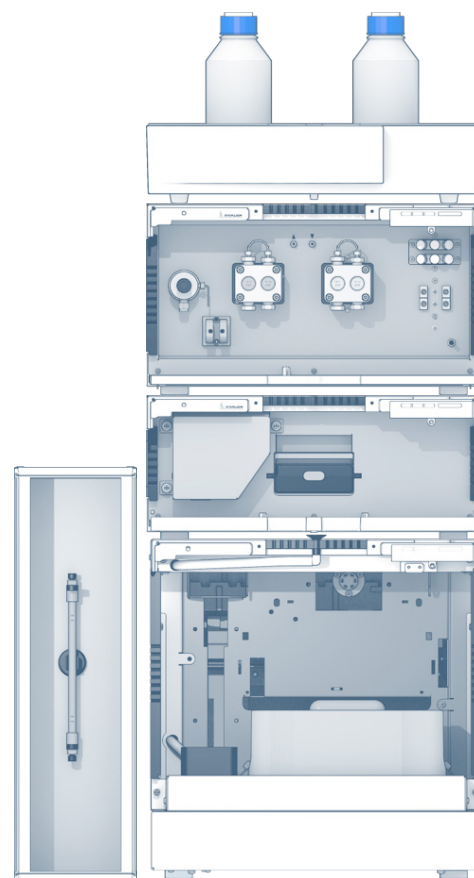

ADDITIONAL RESULTS

Compound	Dried Stevia leaves			Stevia sweetener		
	Average amount (mg/mL)	Mass fraction w (mg/g)	Yield y (%)	Average amount (mg/mL)	Mass fraction w (mg/g)	Yield y (%)
Rebaudioside A	0.099	9.900	0.99	0.724	24.133	2.413
Stevioside	0.265	26.500	2.65	0.114	3.789	0.379
Rebaudioside C	0.045	4.500	0.45	0.002	0.056	0.006
Dulcoside A	0.014	1.400	0.14	-	-	-
Rebaudioside B	0.003	0.300	0.03	0.009	0.289	0.029
Steviolbioside	0.008	0.800	0.08	-	-	-

Tab.A1 Average amount, mass fraction and yield for dried stevia leaves and stevia sweetener samples

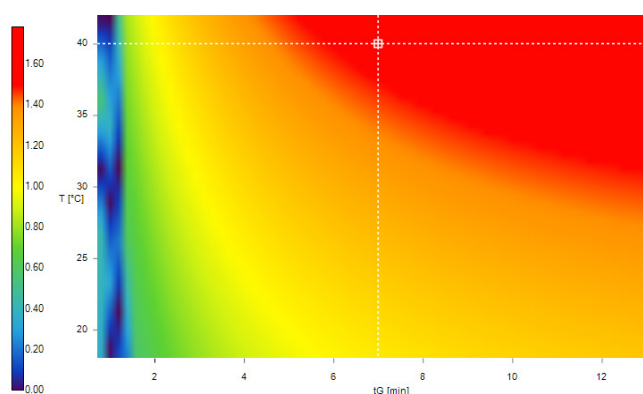

Fig.A1 Resolution map for optimized working point; red = good resolution, blue = poor resolution (Molnar Institute DryLab Version 4.3.1.1)

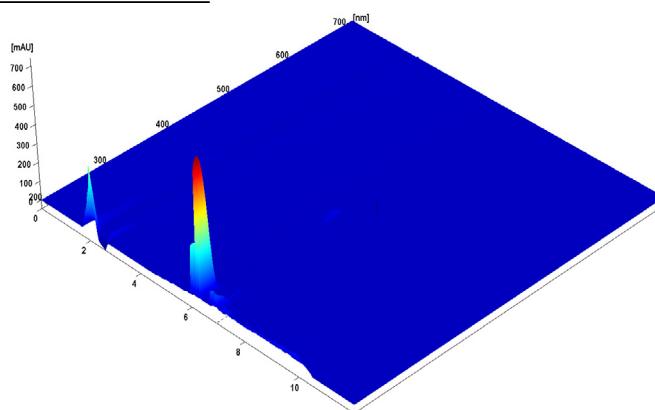

Fig.A2 Acquired PDA 3D Data for Dried Stevia Leaves sample (200 - 700 nm)

ADDITIONAL MATERIALS AND METHODS

Sample extraction: 1 g of dried Stevia rebaudiana leaves were extracted with 25 mL distilled water at 60 °C and sonicated in an ultrasonic bath for 10 min following 30 min of extraction at 60 °C in a water bath. The mixture was centrifuged at 10,000 xg for 20 min at room temperature. The supernatant was transferred to a volumetric flask and the pellet was extracted two more times. The volume was adjusted with water to 100 mL. The extract was then filtered using 0.45 µm hydrophilic filter. 300 mg of common stevia sweetener powder were dissolved in 10 mL distilled water and then a Iso filtered using a 0.45 µm hydrophilic filter. The solution was diluted 1:4 with water before analysis.

Solid phase extraction: The dried Stevia leaves extract was further purified using SPE-cartridges filled with 500 mg Eurospher II 100-20/45 µm C18

Tab.A2 Method parameters

Eluent A	$\text{d}_d\text{H}_2\text{O}$		
Eluent B	Acetonitrile		
Gradient	Time [min]	% A	% B
	0.00	70	30
	1.00	70	30
	8.00	55	45
	8.02	70	30
12.00	70	30	
Flow rate	1.2 mL/min	System pressure	~150 bar
Run temperature	40 °C	Run time	12 min
Injection volume	20 µL	Injection mode	Full loop
Detection wavelength	210 nm	Data rate	20 Hz
		Time constant	0.05 s

material. The cartridge volume (CV) was 3 mL. It was conditioned with 3 CV methanol and then washed with 1 CV water using a vacuum chamber. 2 mL of stevia extract were applied using gravitational force only. The cartridge was washed with 1 CV water and afterwards with 5 mL of 20:80 acetonitrile:water (v/v). For elution 2 mL acetonitrile:water 30:70 (v/v) was used.

Simulation: Parameters temperature (T) and gradient slope (tG) were optimized using DryLab simulation software. Corner stones of the simulation were four experiments: (1) T=40 °C, tG=30 min; (2) T=40 °C, tG=10 min; (3) T=20 °C, tG=30 min; (4) T=20 °C, tG=10 min. As sample calibration standard Level 4 was used.

Tab.A3 System configuration & data

Instrument	Description	Article No.
Pump	AZURA P6.1L. HPG	APH35GA
Autosampler	AZURA AS 6.1L	AAA00AA
Detector	AZURA DAD 2.1L	ADC01
Flow cell	LightGuide UV Flow Cell Cartridge 10mm, 2µL, 50bar	AMC19XA
Column thermostat	AZURA CT 2.1	A05852
Colum	Vertex Plus Column. Eurospher II 100-5 C18, 250 x 4.6 mm ID with precolumn	25VE181E2J
Software	ClarityChrom 7.4.2 - Workstation.	A1670
	autosampler control included ClarityChrom 7.4.2 - PDA extension	A1676

Determination of sugars in honey – comparison of refractive index and light scattering detection



Juliane Böttcher, Kate Monks; applications@knauer.net

KNAUER Wissenschaftliche Geräte GmbH, Hegauer Weg 38, 14163 Berlin; www.knauer.net

SUMMARY

Determination of the sugar content and their composition in honey allows a prediction about the origin of honey and determines how it should be labelled. Because of honey being one of the most popular natural food stuffs and its growing consumption, it is necessary to carry out quality control. Here, the dedicated AZURA® Sugar Analytical System with autosampler upgrade was used for the analysis of sugar in honey. Moreover, refractive index and light scattering detection for this application were compared.

INTRODUCTION

There are well over 50 different kinds of honey on the market, which differ in consistency, colour, and taste. In Germany, the honey ordinance differentiates honey according to the origin, type of extraction, the form of supply or the intended use. Natural bee honey consists of approx. 39 % fructose and approx. 34 % glucose. [1] For example, blossom honey (Blütenhonig) must contain at least 60 % fructose and glucose [2]. In addition, small amounts of sucrose or maltose can be detected [1]. Internationally, products containing more than 5 % sucrose or maltose must no longer be labeled as „pure“ honey [3]. The Association of Official

Analytical Chemist (AOAC) designed a method for the analysis of sucrose, fructose, and glucose in honey (AOAC 977.20). The method is originally performed in HILIC mode, here a KNAUER Eurokat Pb polymer column was used. Since KNAUER has produced its own honey from a bee colony located in the garden, this honey was taken as one of the samples. Furthermore, one commercially available honey and agave nectar were analysed. This application is also used to illustrate the difference between the detection with the AZURA RID 2.1L and the SEDEX LT100 ELSD.



Determination of sugars in honey – comparison of refractive index and light scattering detection

RESULTS

The most important carbohydrates for the evaluation of honey: fructose, glucose, sucrose, and maltose were determined here. Sucrose and maltose were not baseline separated but the resolution was good enough to clearly identify and quantify them. A calibration in a range from 0.03 mg/mL to 1.50 mg/mL for the ELSD and from 0.30 mg/mL to 3.00 mg/mL for the RID was prepared. **Fig 1** shows the traces of a mixed standard at a level of 0.6 mg/mL for both detectors. **Fig 2 and 3** show an overlay of the three different samples measured with ELSD and RID. The KNAUER honey and the fruit blossom honey showed a similar profile. Both

contain more fructose than glucose. Residues of maltose and sucrose were detected. The agave nectar contains more fructose. In comparison its fructose amount is about 1.3 times higher than measured for the honey samples. **Tab A1** (additional results section) summarizes the calculated results for all samples. Calculated results of both detectors are similar. The deviation of certain values might occur due to different calibration functions and different sensitivities of the detectors. The total sugar content (averaged value from both detectors) of the KNAUER honey and fruit blossom honey was around 77% and 73%, respectively.

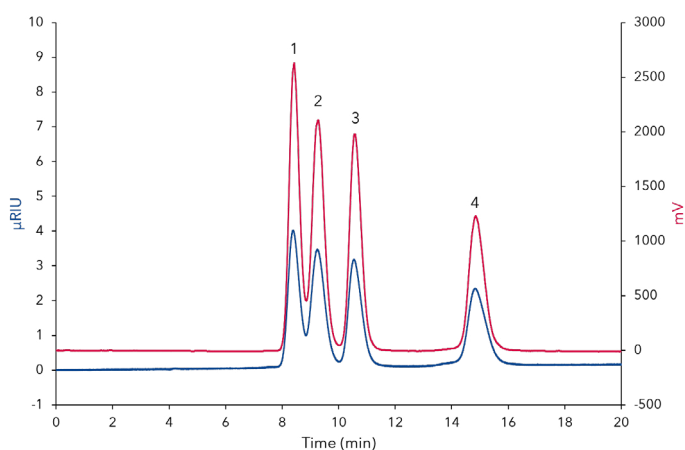

Fig. 1 ELSD trace (red) and RID trace (blue) of a mixed standard at 0.60 mg/mL; 1) sucrose, 2) maltose, 3) glucose, 4) fructose

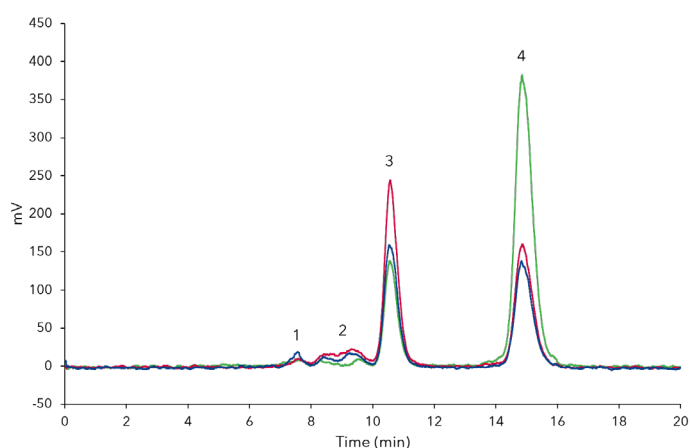
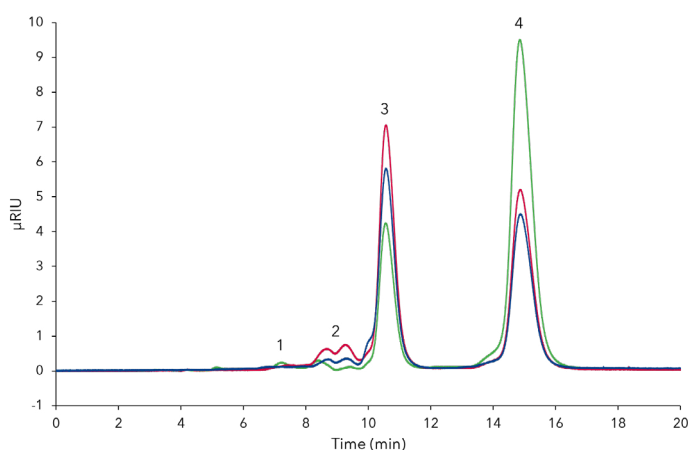

Fig. 2 Overlay of measured samples; ELSD traces: Knauer honey - blue, blossom honey - red, agave nectar - green; 1) sucrose, 2) maltose, 3) glucose, 4) fructose

Fig. 3 Overlay of measured samples; RID traces: Knauer honey - blue, blossom honey - red, agave nectar - green; 1) sucrose, 2) maltose, 3) glucose, 4) fructose



MATERIALS AND METHODS

The AZURA® dedicated system for sugar analytics with an additional autosampler was used for this application. The system consisted of an isocratic AZURA P 6.1L pump, an AZURA AS 6.1L autosampler, an AZURA CT 2.1 column thermostat, and an AZURA RID 2.1L refractive index detector. For the comparison also a SEDEX LT100 ELSD was used. The isocratic method ran at a flow rate of 0.8 mL/min at a column temperature of 75 °C. Water was used as eluent. Detector settings of the RID 2.1L were set to 20 Hz. Nitrogen pressure of ELSD was 3.5 bar. Eluent goes through the nebulizer with a temperature of 65 °C, the filter was set to 10 s and the gain was dynamic. The samples were weighed, and 10 mL of water were added. Before injection a further dilution with water in a ratio 1:100 (ELSD) and 1:10 (RID) was carried out.

CONCLUSION

Obviously, the ELSD provides a much higher sensitivity. A concentration of 0.03 mg/mL was also measured with the RID, but the peaks were too low in comparison to the ELSD and could therefore not be considered for calibration. Chromatograms of this concentration are displayed in the additional results section. The advantage of the RID 2.1L lies in its high linear range up to 1000 μ RIU or more when using the extended dynamic range. It was no problem here to inject the undiluted samples but due to the chosen calibration range a dilution was necessary. The honey samples contained more than 60% fructose and glucose, as expected. The ratio of fructose and glucose was also typical for honey. The more glucose a honey has, the faster it tends to crystallize. The agave nectar showed a different kind of sugar pattern. [1] No matter which detector is chosen, besides the determination of sugars, this application can also be used to differentiate between natural products such as honey and possible substitutes.

REFERENCES

- [1] AID Zucker, Sirupe, Honig, Zuckeraustauschstoffe und Süßstoffe (Nr. 1157)
- [2] Honigverordnung vom 16. Januar 2004 (BGBl I S. 92)
- [3] Codex Alimentarius Commission, 2001; GB18796-2005, 2005

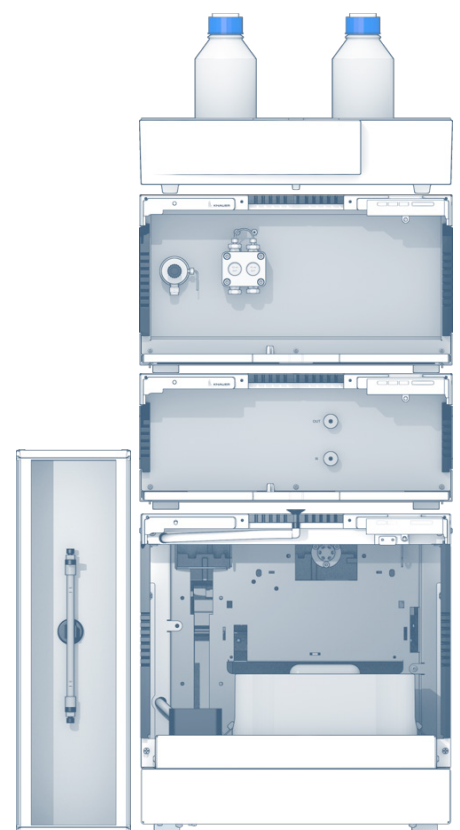

ADDITIONAL RESULTS

Tab. A1 Calculated amounts of sugar in samples

Detection	Sample	Description	Fructose (g/100 g)	Glucose (g/100 g)	Sucrose (g/100 g)	Maltose (g/100 g)	Sugar content (%)
ELSD	1	KNAUER honey	38.20	29.80	2.81	4.16	74.98
ELSD	2	fruit blossom honey	34.07	31.38	1.60	2.41	69.46
ELSD	3	agave nectar	51.34	15.57	0.82	0.94	68.68
RID	1	KNAUER honey	39.20	38.81	not detected	1.57	79.57
RID	2	fruit blossom honey	38.37	35.42	not detected	1.9	75.69
RID	3	agave nectar	52.04	16.3	1.14	0.78	70.25

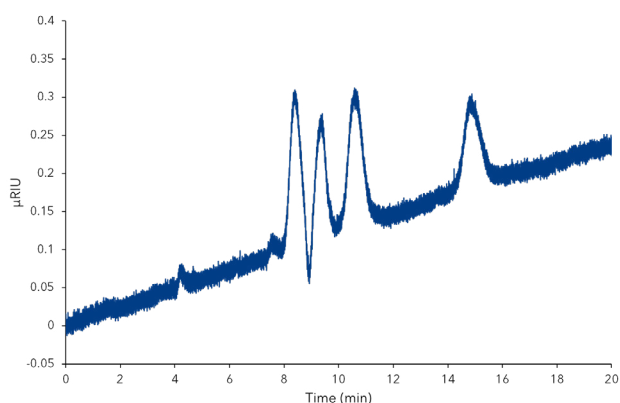

Fig. A1 RID trace of mixed standard at 0.03 mg/mL

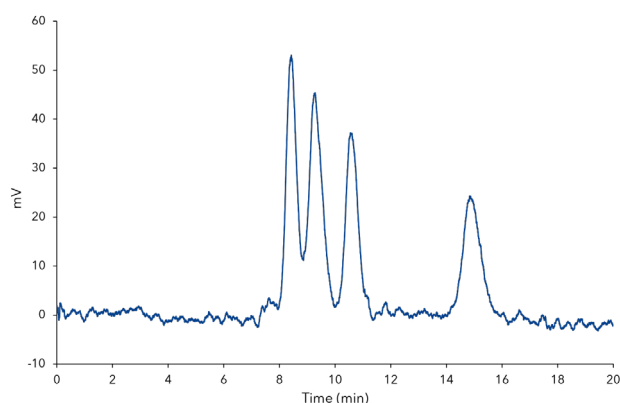

Fig. A2 ELSD trace of mixed standard at 0.03 mg/mL

ADDITIONAL MATERIALS AND METHODS

Tab. A2 Method parameters

Eluent A	ddH_2O		
Gradient	isocratic		
Flow rate	0.8 mL/min	System pressure	~55 bar
Run temperature	75°C	Run time	20-25 min
Injection volume	20 μL	Injection mode	Full loop
Detection wavelength	RID	Data rate	20 Hz
		Time constant	0.05 s
Detection	ELSD	Temperature	65°C
		Filter	10 s
		Gain	Dynamic
		Nitrogen pressure	3.5 bar

Tab. A3 System configuration

Instrument	Description	Article No.
Pump	AZURA P6.1L, isocratic	APH30EA
Autosampler	AZURA AS 6.1L	AAA10AA
Detector	AZURA RID 2.1L	ADD31
Detector	Light Scattering Detector Sedex 100LT	A0754-6
Column thermostat	AZURA CT 2.1	A05852
Column	Vertex Plus Column, Eurokat Pb, 10 μm , 300 x 8 mm ID Vertex Plus Column, Eurokat Pb, 10 μm , 30 x 8 mm ID	30GX350EKN 03GX350EKN
Software	ClarityChrom 7.4.2 - Workstation, auto-sampler control included	A1670

RELATED KNAUER APPLICATIONS

[VFD0160](#) - Determination of sugars and natural sugar substitutes in different matrices

[VFD0161](#) - Determination of sugars in honey using HILIC separation and RI detection

[VFD0155](#) - Semi preparative xylitol purification with dedicated sugar purification system

[VSP0013](#) - Simplified scale up for sugars with the AZURA RID 2.1L extended dynamic range option

Scale-up of an analytical HPLC method for steviol glycosides to a preparative approach

Johannes Menke, Yannick Krauke, Kate Monks; applications@knauer.net
KNAUER Wissenschaftliche Geräte GmbH, Hegauer Weg 38, 14163 Berlin – www.knauer.net



SUMMARY

Steviol glycosides are the main sweetening compounds in *Stevia rebaudiana* and can be used as natural sugar substitutes due to their far higher sweetening power than normal sucrose or glucose. The sweetness is estimated to be about 400 times higher. This application describes an easy transfer of an existing analytical HPLC method to a preparative HPLC using overload experiments together with the KNAUER Scale-Up converter. Furthermore, this approach of scale-up is also applicable for different analytes and thus provides a fast scale-up.

INTRODUCTION

For several years research has been undertaken to find sugar substitutes that are calorie free but have the same taste and properties as classic sugar, for diabetics and as part of a calorie-controlled diet. One popular substitute is the so-called "Stevia" which is a mixture of steviol glycosides isolated from the plant *stevia rebaudiana* [1]. The steviol glycoside rebaudioside A is the main compound of interest as it is the

sweetest and less bitter compound of the extract. Often a mixture of rebaudioside A and stevioside is found in the "Stevia" products.

The development of a purification method with high yield of rebaudioside A, few stevioside impurities, and a high throughput would increase the economic output of stevia production.



Scale-up of an analytical HPLC method for steviol glycosides to a preparative approach

RESULTS

In analytical scale an isocratic method was developed for the purification of rebaudioside A and stevioside from stevia leaves. The previously described gradient method (application note VFD0168) was transferred to isocratic mode using the DryLab (Molnár-Institute, Germany) software. The isocratic method derived from the simulation was further developed for the gradient method. A concentration of 30:70 acetonitrile:water (v/v) showed the best performance (data not shown). A mix-standard of rebaudioside A, stevioside, rebaudioside C, dulcoside A, rebaudioside B, and steviolbioside with individual concentrations of 0.1 mg/mL was used as sample. Comparison of the gradient and isocratic method showed, that the two target peaks (rebaudioside A and stevioside) were nearly baseline separated but eluted later and were broader (Fig. 1A, 1 and 2). Hence, this isocratic method was transferred to an analytical column with 10 μm particles. This

was done to ease the scale up to the preparative scale with a column with the same material.

Overload experiments in the analytical scale showed that 100 μL and 200 μL injection volume lead to overlapping of the two main peaks (Fig. 1B). Stevia extract obtained from dried stevia leaves was used for the experiments, both analytical and preparative scale.

The method was scaled up with the KNAUER ScaleUp Converter from the original ID 4.6 mm to an ID 20 mm column maintaining the length of 250 mm and thus keeping the HETP constant. The flow rate was increased from 1.2 mL/min to 22 mL/min.

Injections of up to 2 mL sample still showed a minimal separation of both peaks (Fig. 2). The matrix peak (1-5 min) increased significantly (Fig. 2, blue bars).

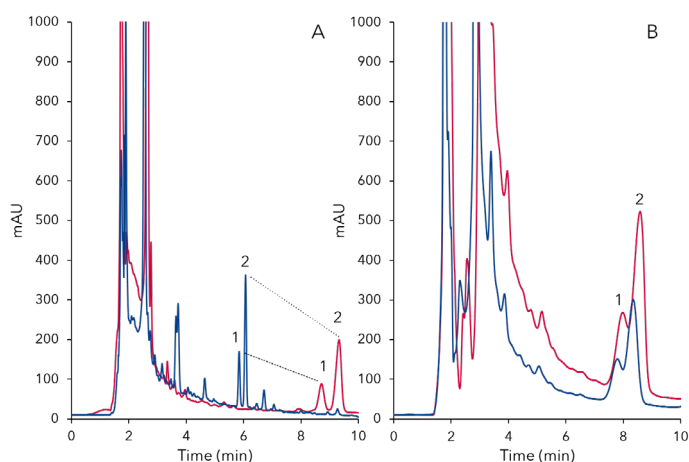

Fig. 1 A - Transfer gradient to isocratic method; 1) rebaudioside A, 2) stevioside; isocratic 30:70 acetonitrile/H₂O, 20 μL injections, C18, 5 μm particle, 1.2 mL/min, 30°C B - Overlay chromatograms 100 μL (blue) and 200 μL (red) sample injection on analytical 10 μm particle column; 1) rebaudioside A, 2) stevioside; 30:70 acetonitrile/H₂O, C18, 1.2 mL/min, 30°C

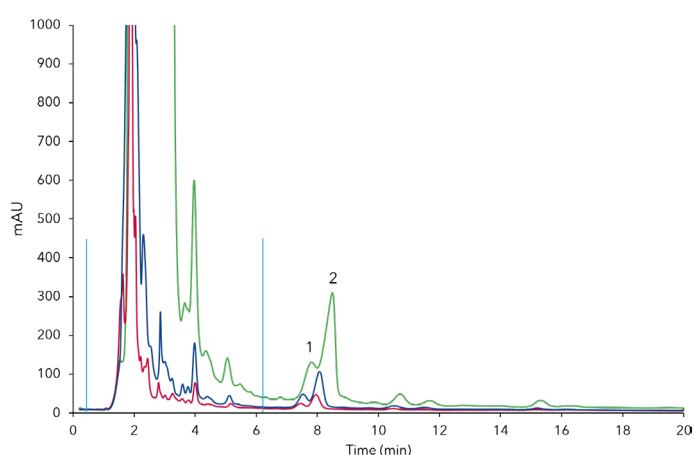

Fig. 2 Overload experiments on preparative column, 200 μL (red), 500 μL (blue), 2000 μL (green); 1) rebaudioside A, 2) stevioside, blue bars - matrix, 25°C, 22 ml/min

REFERENCES

- [4] "Stevia Leaf to Stevia Sweetener: Exploring Its Science, Benefits, and Future Potential" P. Samuel, K. T. Ayoob, B. A. Magnuson, et al. J Nutr, Volume 148, Issue 7, 1 July 2018, Pages 1186S-1205S.
- [5] KNAUER scale up converter ([link](#))

MATERIALS AND METHODS

The AZURA HPLC Plus System was used for analysis as described in application note [VFD0168](#). A composition of A: water and B: acetonitrile was used as eluent. For the method transfer from gradient mode to isocratic a Vertex Plus column filled with Eurospher II 100-10 C18 silica in a dimension 250 x 4.6 mm ID with precolumn was used. The flow was set to 1.2 mL/min. The scale-up was calculated using the KNAUER ScaleUp Converter [2] ([Fig A1](#)).

The AZURA Preparative HPLC system consisted of AZURA P 2.1L 100 mL sst pump with ternary LPG

module, AZURA UVD 2.1L detector with 3 mm, 2 μ l flow cell, an AZURA assistant module with a 12 port multi position 1/8" sst valve (solvent selection), a 6 port 2 position 1/16" sst injection valve, a P 4.1S 50 ml sst feed pump and a Labocol vario-4000 fraction collector. For the method transfer from analytical to preparative scale a KNAUER Vertex Plus AX column, Eurospher II 100-10 C18, 250 x 20 mm ID was used. The flow was scaled to a rate of 22 mL/min. Peaks were fractionated using 3 mL fractions and analyzed using an analytical HPLC as described in application note [VFD0168](#).

CONCLUSION

Using simulation software provided a quick transfer from gradient elution to an isocratic method which could be established using the later preparative column material but in analytical column dimensions. In the following a fast method-transfer from an analytical to a preparative HPLC approach could be achieved using the KNAUER ScaleUp Converter. The isocratic HPLC method was successfully transferred to a preparative scale while keeping the elution characteristics of the target analytes rebaudioside A and stevioside. The overload experiments also showed a maximum column loading capacity both analytical and preparative. Thus, for following experiments an easy estimate concerning sample load is possible. In addition, the overload experiments depict the need for matrix reduction, as the matrix signal is close to overlay the target signal if not being decreased.

Concluding the derived preparative method was well suited as a starting point for follow up experiments as described in application note [VFD0171](#).

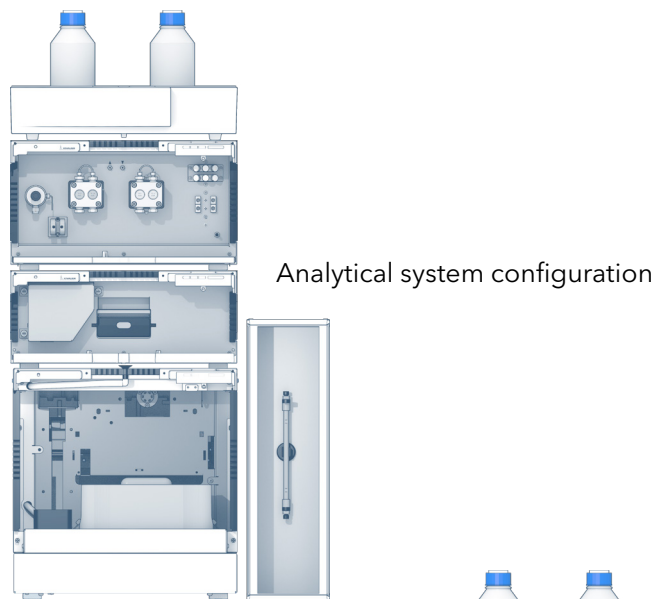

Analytical system configuration

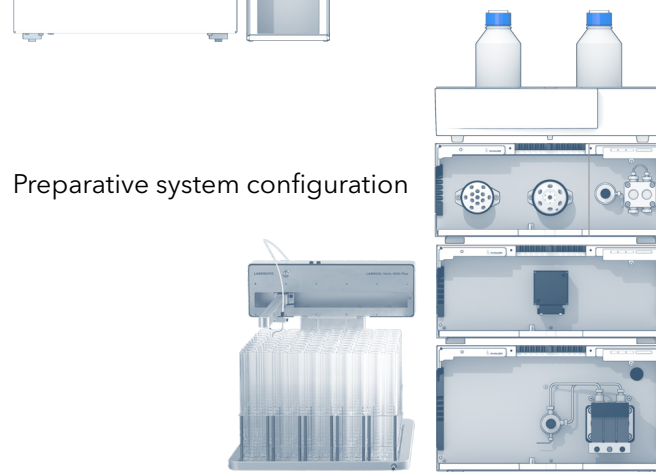

Preparative system configuration

ADDITIONAL RESULTS

The screenshot shows the KNAUER Scale-up converter software interface. It is divided into two main sections: Column 1 and Column 2. Each section has sub-sections for Column Parameters, Method Settings, and Gradient. The values for Column 1 are: Column Length: 250.0 mm, Column ID: 4.6 mm, Particle Size: 10.0 μm, Flow Rate: 1.20 ml/min, Injection Volume: 200.0 μl, Mass load scaling: 50.0 mg, Run Time: 20.00 min, Column Void Volume: 2.82 ml, and Gradient Steps: No Gradient. The values for Column 2 are: Column Length: 250.0 mm, Column ID: 20.0 mm, Particle Size: 10.0 μm, Flow Rate: 22.68 ml/min, Injection Volume: 3780.7 μl, Mass load scaling: 945.2 mg, Run Time: 20.00 min, Column Void Volume: 53.38 ml, and Gradient Steps: No Gradient.

Fig. A1 Linear scale up with KNAUER Scale-up converter

ADDITIONAL MATERIALS AND METHODS

Tab. A1 Sample preparation

For the analytical experiments 1 g of dried stevia leaves were extracted in water as described in application note VFD0168.

A highly concentrated sample of stevia extract was prepared for the preparative experiments. 15g of dried stevia leaves were extracted in 200 mL water, prepared as described in application note VFD0168 and adjusted to a final volume of 250 mL. Additional centrifugation steps were necessary to remove particles from the solution before and after filtration.

Tab. A2 Method parameters

	Analytical	Preparative
Column temperature	30 °C	RT
Injection volume	50 μL; 100 μL; 200 μL	500 μL; 1000 μL; 2000 μL
Injection mode	Full loop / Partial loop	Full loop
Detection wavelength	UV 210 nm	UV 210 nm
Data rate	20 Hz	2 Hz

Tab. A3 Pump parameters (analytical)

Eluent A	ACN:H ₂ O 30:70 (v/v)
Flow rate	1.2 mL/min
Pump program	isocratic 30% B

Tab. A4 Pump parameters (preparative)

Eluent A	ACN:H ₂ O 30:70 (v/v)
Flow rate	22 mL/min
Pump program	isocratic

Tab. A5 System configuration

Instrument	Description	Article No.
Pump 1	AZURA P 2.1L, 100 mL, sst	APE20KA
Pump 2	AZURA LPG ternary module for Pump P 2.1L	AZZ00AB
Detector	AZURA UVD 2.1L	APH30EA
Flow cell	3 μl; 1/16"	
Assistant	AZURA ASM 2.1L Left: 12 Mpos, 1/8", sst Middle: 6 Port 2Pos, 1/16", sst Right: P4.1S, 50 mL, sst	AYEKEABR
Fraction collector	Labocol Vario-4000	A591022
Column	KNAUER Vertex Plus AX Eurospher II 100-10 C18, 250 x 20 mm ID	25PE181E2N
Software	PurityChrom5 Basic KNAUER ScaleUp Converter	A2650 A1696

RELATED KNAUER APPLICATIONS

[VFD0168](#) - Oh so sweet - Quantification of steviol glycosides in Stevia samples with RP-HPLC

[VFD0171](#) - Advantages of preparative online SPE compared to batch LC for stevia purification

[VFD0174](#) - Determination of six steviol glycosides using reversed phased HPLC and online SPE

A D E K - Easy separation of fat-soluble vitamins using GPC/SEC

Juliane Boettcher, Jan Wendrich, Kate Monks; applications@knauer.net
KNAUER Wissenschaftliche Geräte GmbH, Hegauer Weg 38, 14163 Berlin;
www.knauer.net



SUMMARY

Vitamins are essential micronutrients that are needed in small amounts for various roles throughout the human body. Vitamins are divided into two groups: water-soluble (B-complex vitamins and C vitamins) and fat-soluble vitamins (A, D, E, and K). The fat-soluble vitamins are stored in the body for long periods of time and generally pose a greater risk for toxicity when consumed in excess than water-soluble vitamins [1]. Here, an analytical HPLC method based on size exclusion chromatography is described.

INTRODUCTION

Fat-soluble vitamins are required for a wide variety of physiological functions. They are absorbed in the intestine in the presence of fat. Classical deficiencies of these vitamins can manifest clinically as night blindness (vitamin A), osteomalacia (vitamin D), increased oxidative cell stress (vitamin E), and haemorrhage (vitamin K) [2]. Since megadoses of vitamins A, D, E, or K can be toxic and may lead to health problems, it is necessary to provide quality control of dietary supplement products to guarantee the right indication of vitamin concentration. Therefore, a HPLC method for the analysis of fat-soluble vitamins was developed based on the separation principle of size exclusion.

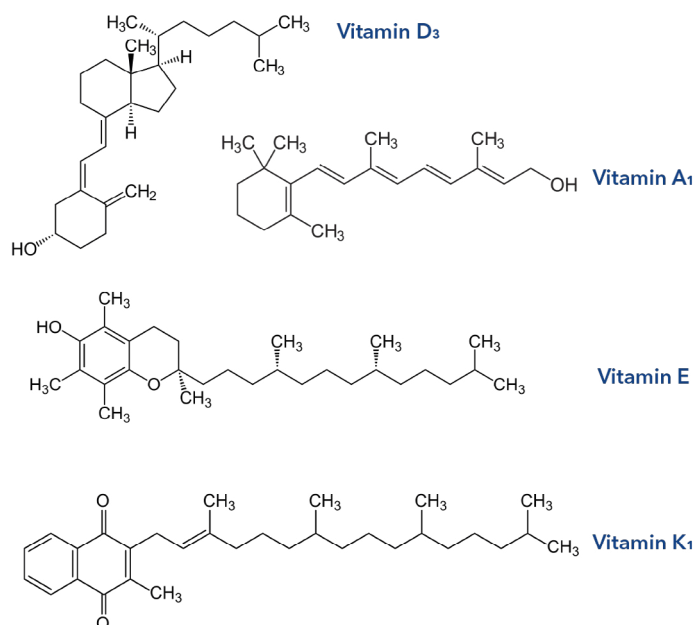

Structural formulas of typical fat-soluble vitamins



A D E K - Separation of fat-soluble vitamins using GPC/SEC

RESULTS

A mixed standard of the fat-soluble vitamins was prepared and dissolved in tetrahydrofuran. For quantification, calibration curves for the four vitamins in ranges from 0.002 mg/mL to 0.1 mg/mL for vitamins A, D, K and from 0.0045 mg/mL to 0.18 mg/mL for vitamin E were determined. **Fig. 1** shows the mixed vitamin standard at a concentration of 0.05 mg/mL (A, D, K) and 0.09 mg/mL (E). The calibration showed a good

linearity and for all compounds $R^2 > 0.999$ was achieved (**Fig. 2**). **Tab. 1** summarizes the calculated LOD (S/N=3) and LOQ (S/N=10) values for the separation. Vitamin E showed the least sensitivity but nevertheless LOD and LOQ values reside in an appropriate range e.g. the analysis of dietary supplement products, where high amounts of vitamins are expected.

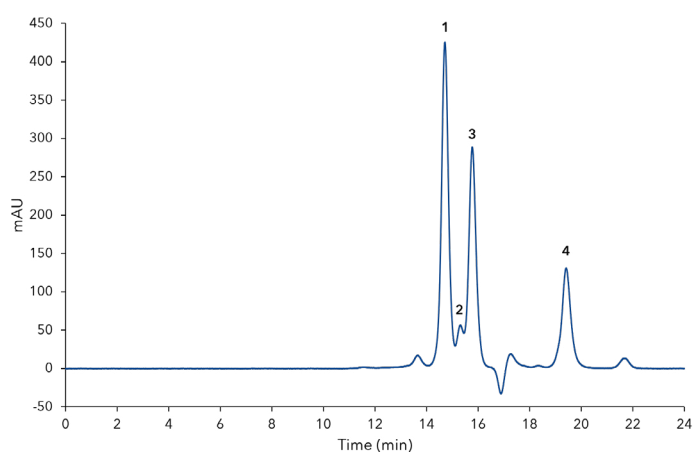

Fig. 1 Chromatogram of a mixed standard of fat-soluble vitamins at 0.05 mg/mL (A, D, K) and 0.09 mg/mL (E), 1) vitamin A palmitate, 2) vitamin E, 3) vitamin D3, 4) vitamin K

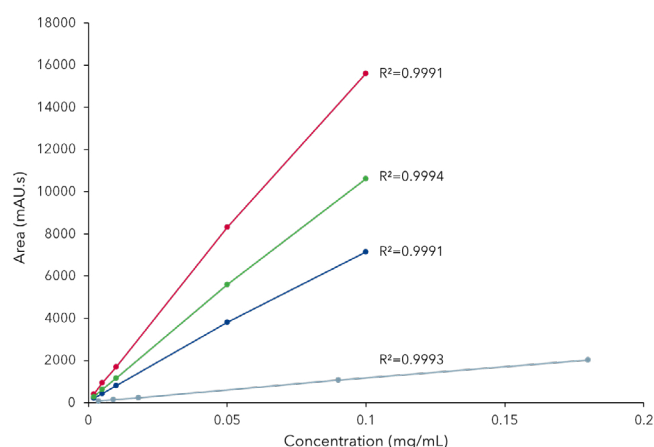

Fig. 2 Calibration curves for vitamin D3 (red), vitamin A (green), vitamin K (blue), and vitamin E (grey); corresponding linearity values are indicated

Tab. 1 Calculated LOD and LOQ values

Substance	LOD (S/N=3) in $\mu\text{g/mL}$	LOQ (S/N=10) in $\mu\text{g/mL}$
Vitamin A palmitate	0.10	0.34
Vitamin E	2.00	6.40
Vitamin D3	0.16	0.54
Vitamin K	0.40	1.33

MATERIALS AND METHODS

The used AZURA® analytical system was equipped with an AZURA P 6.1L pump suitable for normal phase applications. Furthermore a 2 channel GPC degasser was used. Acquisition was performed with an AZURA UVD 2.1L and an analytical flow cell. For injection, an AZURA autosampler AS 6.1L was used. The column thermostat CT 2.1 was part of the system. The isocratic method ran at a flow rate of 1 mL/min for 25 minutes. Stabilized tetrahydrofuran was used as eluent. The column temperature was set to 40 °C and vitamins were detected at 280 nm. A column tandem was used of two times AppliChrom ABOA StyDiViBe, with a pore size of 35 Å, covering a molecular weight range from 100 to 2500 Da in a dimension 300 x 8 mm ID.

CONCLUSION

The isocratic method based on size exclusion separation mechanism is an easy possibility for the determination of the four fat-soluble vitamins and a valuable addition to commonly used reversed phase gradient methods. Although, the peaks are not completely baseline separated it is possible to perform quantification. The method can be used for the quality control of dietary supplement products. To obtain a better resolution for vitamin E, the extension of the separation distance would be reasonable. This could be achieved by adding a third column with the same pore size.

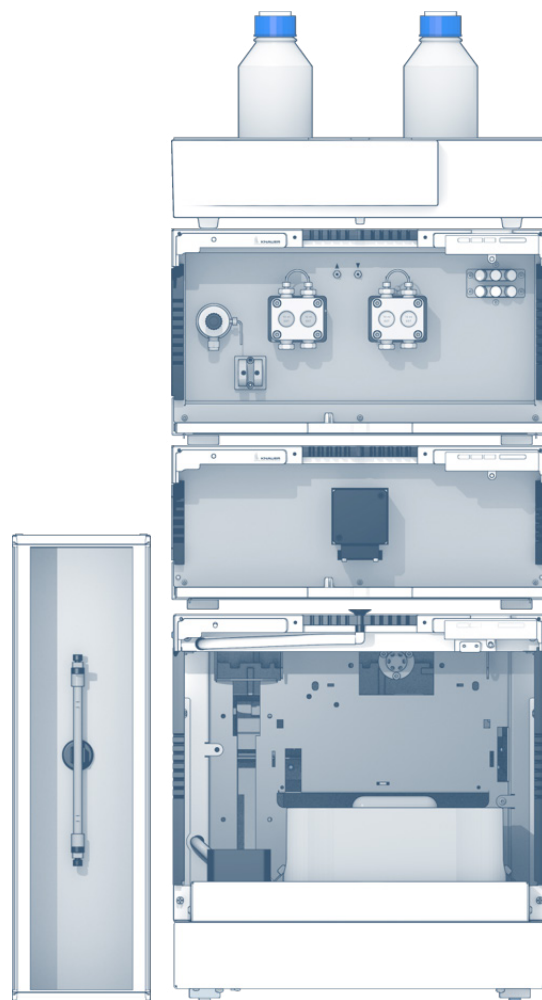

REFERENCES

- [6] Fat-Soluble Vitamins: A, D, E, and K; Fact Sheet No. 9.315, Food and Nutrition Series/Health, <http://extension.colostate.edu/topic-areas/nutrition-food-safety-health/fat-soluble-vitamins-a-d-e-and-k-9-315/>
- [7] Fat-Soluble Vitamins: Clinical Indications and Current Challenges for Chromatographic Measurement, Ali A. Albahrani and Ronda F. Greaves; <https://www.ncbi.nlm.nih.gov/pmc/articles/PMC4810759/>

ADDITIONAL MATERIALS AND METHODS

Tab. A1 Method parameters

Column temperature	40°C
Injection volume	100 µL
Injection mode	Full loop
Detection	UV 280 nm
Data rate	20 Hz
Time constant	0.05 s

Tab. A2 Pump parameters

Eluent A	Tetrahydrofuran (stabilized)
Flow rate	1 mL/min
Pump program	isocratic
Run time	25 min

Tab. A3 System configuration

Instrument	Description	Article No.
Pump	AZURA P 6.1L, HPG for normal Phase	APH38ED
Degasser	2 channel GPC degasser	A5335
Autosampler	AZURA AS 6.1L	AAA00AA
Detector	AZURA UVD 2.1L	ADA01XA
Flow cell	Analytical UV Flow Cell	A4061XB
Thermostat	AZURA CT 2.1	A05852
Column	2 x AppliChrom ABOA StyDiViBe, 35 Å (100 - 2500 Da), 5 µm, 300 x 8 mm ID	30GA470ABJ
Software	ClarityChrom 7.4.2 - Workstation, autosampler control included	A1670

RELATED KNAUER APPLICATIONS

[VFD0162](#) - Separation of ascorbic acid and vitamin B complexes - essentially required nutrients

Advantages of preparative online SPE compared to batch LC for stevia purification



Johannes Menke², Yannick Krauke¹, Juliane Böttcher¹, Corinna Lippmann², Kate Monks¹; applications@knauer.net

¹KNAUER Wissenschaftliche Geräte GmbH, Hegauer Weg 38, 14163 Berlin; www.knauer.net

²Staatliche Technikerschule Berlin, Bochumer Str. 8B, 10555 Berlin

SUMMARY

Steviol glycosides are the main sweetening compounds in *Stevia rebaudiana*. Due to their up to 400 times higher sweetening power compared to sucrose or glucose they are often used as natural sugar substitutes. To enable a commercial usage, the plant extracts need to be purified. In this work preparative online SPE (solid phase extraction) was investigated for improvement of overall purity due to reduction of matrix contamination.

INTRODUCTION

For several years research has been undertaken to find sugar substitutes that are calorie-free but have the same taste and properties as classic sugar. Such substitutes are important especially in diets necessary for diabetics and increasingly as part of the so-called "low-carb" movement. One popular substitute is "Stevia" which is a mixture of steviol glycosides isolated from the plant *Stevia rebaudiana* [1]. The steviol

glycoside rebaudioside A is the main compound of interest as it is the sweetest and less bitter compound of the extract. Often Stevia products contain a mixture of rebaudioside A and stevioside. The development of a purification method with high yield of rebaudioside A, only few stevioside impurities, and high throughput would increase the economic output of Stevia production.



Advantages of preparative online SPE compared to batch LC for stevia purification

RESULTS

For purification of rebaudioside A and stevioside from stevia leaves a gradient method for analysis of stevio glycosides was transferred to an isocratic method (VFD0170). The final method was up-scaled with the KNAUER up-scale converter [2] to an ID 20 mm column of same length as the analytical column, increasing the flow rate from 1.2 mL/min to 22 mL/min. Sample injections of up to 2 mL still showed a slight separation of the rebaudioside A and stevioside peaks (Fig 1). The matrix peak (1-5 min) increased significantly (Fig 1, blue). Large sample matrix can negatively affect the separation abilities and wear off the main column therefore elimination of matrix prior to the purification is desirable. An online-SPE method was developed with a short preparative column in front of the main

column. 10 mL of sample were loaded, the matrix washed away and then the target compounds were injected on the main column (Fig 2). Comparison of the chromatograms of the classical batch process (Fig 1) and the online-SPE process (Fig 2) showed that the automated SPE process significantly decreased the matrix. The fraction analysis revealed that only a small part of the overlapping peak contained nearly pure rebaudioside A; fractions 3-5 approx. 15 mL with >90 % rebaudioside A and <10 % stevioside (Fig 3, B). The later fractions contained high amounts of stevioside but also still rebaudioside A (Fig 3, C). The results showed that purification of highly pure rebaudioside A is possible by introducing an additional online-SPE step, however yield is sacrificed.

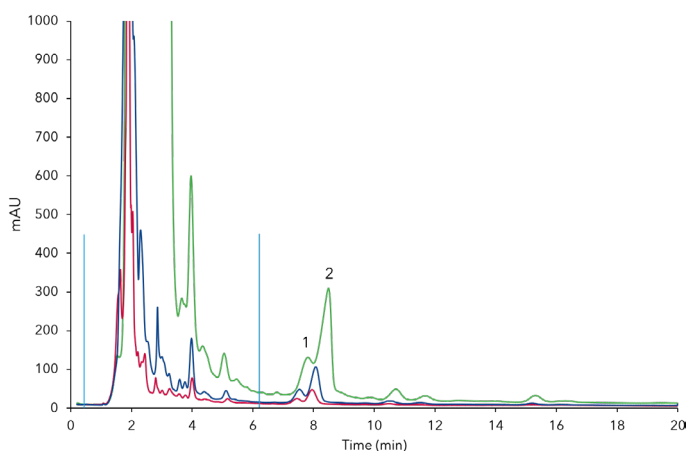

Fig. 1 Overload experiments on preparative column, 200 µL (red), 500 µL (blue), 2000µL (green); 1) rebaudioside A, 2) stevioside, blue bars - matrix, 25°C, 22 ml/min

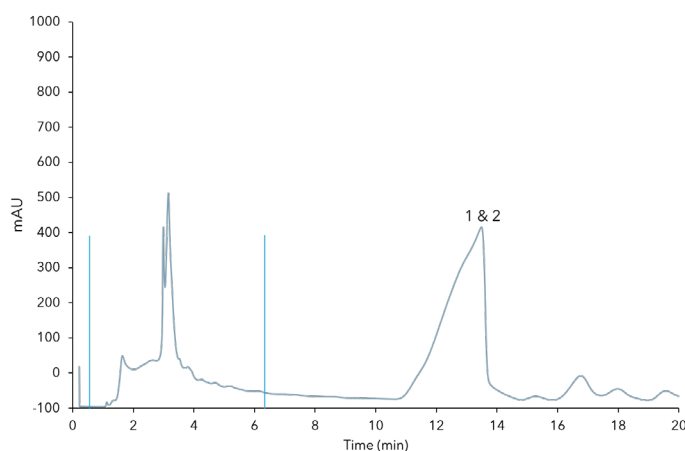
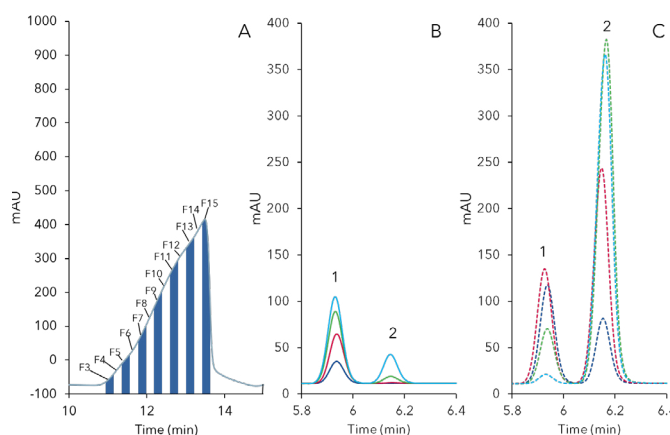

Fig. 2 Preparative online SPE, 10 mL loading; 1) rebaudioside A, 2) stevioside, blue bars - matrix, 25°C, 22 mL/min

Fig. 3 Fraction analysis of preparative online-SPE purification Fig 2) of rebaudioside A (1) and stevioside (2); A) fractionation of target peak, 5 mL fractions B) F3 (blue), F4 (red), F5 (green), F6 (light blue); C) F7 (red dashed), F10 (blue dashed), F12 (green sashed), F15 (light blue dashed)



MATERIALS AND METHODS

The AZURA Preparative HPLC system consisted of AZURA P 2.1L 100 mL sst pump with ternary LPG module, AZURA UVD2.1L detector with 3 mm, 2 µl flow cell, an AZURA assistant module with a 6 port multi position 1/8" sst valve (solvent selection), a 6 port 2 position 1/16" sst injection valve, a P 4.1S 50 ml sst feed pump and a Labocol vario-4000 fraction collector. Final purification method was divided into two phases: SPE loading and target purification. SPE loading: 1) Conditioning 1.5 min with 20 mL/min 100 % ACN; 2) Re-equilibration 2.5 min with 20 mL/min 20/80 ACN/H₂O; 3) sample loading 1 min 5 mL/min 4) Washing 6.5 min with 20 mL/min; target purification: 20 min with 22 mL/min 30/70 ACN/H₂O; at 210 nm and 25°C. Fraction analysis was performed with AZURA analytical HPLC system as described in application note [VFD0168](#).

REFERENCES

[1] "Stevia Leaf to Stevia Sweetener: Exploring Its Science, Benefits, and Future Potential" P. Samuel, K. T. Ayooob, B. A. Magnuson, et al. J Nutr, Volume 148, Issue 7, 1 July 2018, Pages 1186S-1205S

[2] Scale up converter:
<https://www.knauer.net/en/knauer-scaleup-converter/p14082>

CONCLUSION

A preparative HPLC approach for the purification of the most preferred steviol glycoside rebaudioside A from dried stevia leaves was investigated. During the method development an automatic online-SPE method was established thus reducing significantly the matrix in the sample. That should protect the main column from contamination and increases the loading with the main compounds. Nevertheless, the two components rebaudioside A and stevioside are coeluting and a clean separation is not possible under tested conditions. Pure rebaudioside A can be purified but with low yield.

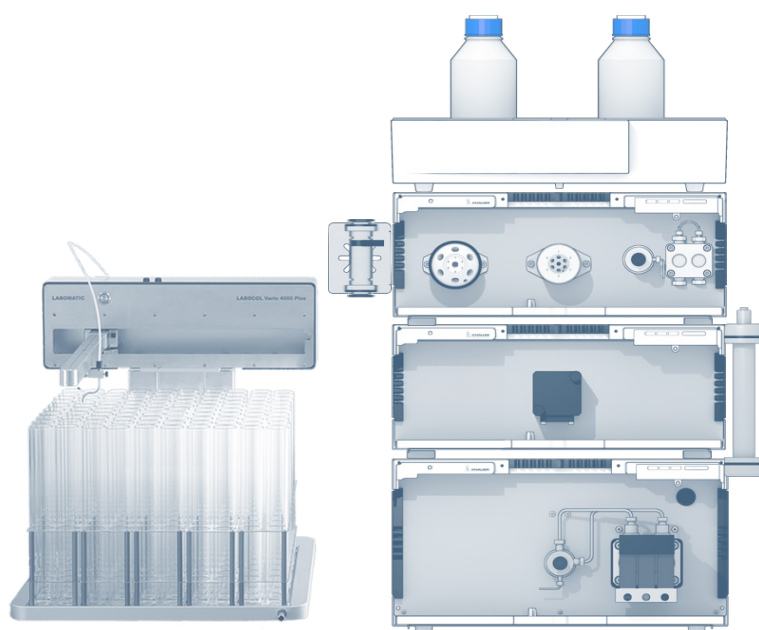

ADDITIONAL RESULTS

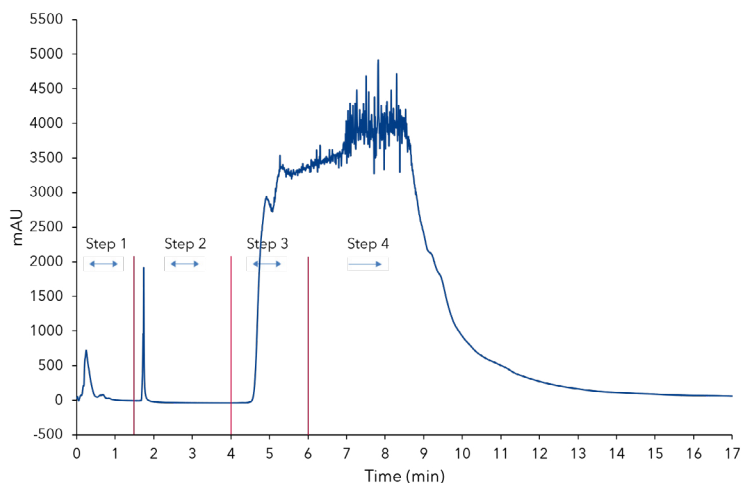

Fig. A1 Sample loading on SPE column, 10 mL sample, step 1 - conditioning, step 2 - re-equilibration, step 3 - sample loading, step 4 - washing

ADDITIONAL MATERIALS AND METHODS

Tab. A1 Method parameters (preparative online-SPE)

Eluent A	100 % ACN				
Eluent B	20 %/80 % ACN/H ₂ O				
Sample	Concentrated stevia extract				
Step	Flow rate	Time (min)	% A	% B	Sample (%)
Conditioning	20 mL/min	1.5	100	0	0
Re-equilibration	20 mL/min	2.5	0	100	0
Sample loading	5 mL/min	2	0	0	100
Washing	20 mL/min	9.5	0	100	0
Run temperature	25°C	Run time	15.5 min		
Injection volume	10 mL	Injection mode	Feed pump		
Detection wavelength	210 nm	Data rate	2 Hz		
		Time constant	0.05 s		

Tab. A2 Method parameters (preparative method)

Eluent A	30 %/70 % ACN/H ₂ O		
Eluent B	-		
Gradient	isocratic		
Flow rate	22 mL/min	System pressure	80 bar
Run temperature	25°C	Run time	20 min
Injection volume	From above	Injection mode	-
Detection wavelength	210 nm	Data rate	2 Hz
		Time constant	0.05 s

Tab. A3 System configuration

Instrument	Description	Article No.
Pump	AZURA P 2.1L, 100 mL, SST AZURA ternary module for P 2.1L	APE20KA AZZ00AB
Detector	AZURA UVD 2.1L	ADA01XA
Assistant	Left: 6 Mpos, 1/8", sst Middle: 6Port2Pos, 1/16", sst Right: P4.1S, 50ml, sst	AYEKEABR
Flow cell	3 mm, 2 µL; 1/16"	A4069
Column	Eurosphere II 100-10 C18 250x4.6 mm Eurosphere II 100-10 C18 250x20 mm Eurosphere II 100-5 C18 30x20 mm	25VE181E2N 25PE181E2N 03PE181E2J
Fraction collector	Labocol Vario-4000	A591022
Software	PurityChrom5 Basic	A2650

RELATED KNAUER APPLICATIONS

[VFD0168](#) - Oh so sweet - Quantification of steviol glycosides in Stevia samples with RP-HPLC

[VFD0155](#) - Sensitive online SPE determination of Bisphenol A in water samples

Be(e) wary - determination of neonicotinoid insecticides in honey

Juliane Böttcher, Kate Monks; applications@knauer.net
KNAUER Wissenschaftliche Geräte GmbH, Hegauer Weg 38, 14163 Berlin; www.knauer.net



SUMMARY

Neonicotinoids are active substances used in plant protection products to control harmful insects. They are systemic pesticides, which means that they are taken up by the plant and transported through its leaves, flowers, roots, and stems, as well as pollen and nectar. Neonicotinoids affect the central nerve system of insects, leading to eventual paralysis and death [1]. Three honey samples from different sources were analysed for neonicotinoid content according to current regulating guidelines via a fast and simple HPLC method.

INTRODUCTION

Neonicotinoids are one of the most widely used classes of pesticides [2]. Five neonicotinoid insecticides are approved as active substances in the EU for the use in plant protection products, namely clothianidin, imidacloprid, thiamethoxam, acetamiprid, and thiacloprid [1]. They are closely monitored by the European Commission. Because of the potential risk for bees, the use of three of the substances (imidacloprid, clothianidin, thiamethoxam) was restricted in 2013 (see Regulation (EU) No 485/2013) [3]. In April 2018, the European Commission banned these three neonicotinoids for the outdoor use and only the permit for usage in permanent greenhouse remains [4]. For acetamiprid the EFSA established a low risk to bees.

A ban or further restrictions of this substance are neither scientifically nor legally appropriate. The fifth neonicotinoid, thiacloprid, is a candidate for substitution based on its endocrine disrupting properties [3]. In this application clothianidin, thiamethoxam, imidacloprid, and acetamiprid in honey samples are determined referring to the maximum residue levels which are specified in Commission Reg. (EU) 2017/671 [5], Commission Reg. (EU) 491/2014 [6] and Commission Reg. (EU) 2017/626 [7]. Three different honey samples have been tested. One of the samples was the KNAUER honey, produced from a bee colony located in the KNAUER garden. The other ones were commercially available canola honey and fruit blossom honey.



Be(e) wary – determination of neonicotinoid insecticides in honey

RESULTS

A reversed phase method was developed where the four neonicotinoids are baseline separated. The method was optimized regarding temperature and gradient slope using DryLab simulation software. A calibration in a range from 0.5 $\mu\text{g/mL}$ to 10 $\mu\text{g/mL}$ was prepared. **Fig 1** shows the separation of a mixed standard at a concentration of 10 $\mu\text{g/mL}$. The calibration showed a good linearity and all correlation coefficients are calculated as $R^2 > 0.9996$. Based on the measurement at a concentration of 0.5 $\mu\text{g/mL}$ the LOD and LOQ were calculated. The calculated values for the single compounds are summarized in **Tab A1** (additional information). Sample preparation was carried out using a citrate-buffered QuEChERS

extraction. The recovery rate including sample preparation was determined at three different levels: LOQ, 2 x LOQ, upper end of calibration. For the compounds following recovery rates were calculated (averaged values over all levels): clothianidin 87 %, thiamethoxam 91 %, imidacloprid 92 % and acetamiprid 95 %. Furthermore, three different honey samples were analyzed regarding neonicotinoids. **Fig 2 to 4** show the chromatograms of the QuEChERS extracted and cleaned samples. In one of three samples residues of clothianidin were detected but they were in the range of limit of detection and hence far below the maximum residue level of 0.05 mg/kg for honey and other apiculture products [8].

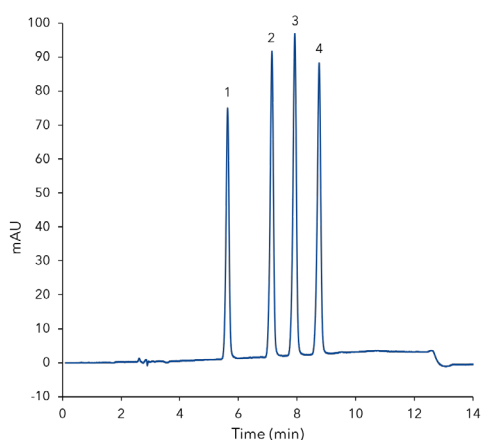

Fig. 1 Chromatogram of mixed standard at 10 $\mu\text{g/mL}$, 1) thiamethoxam, 2) clothianidin, 3) imidacloprid, 4) acetamiprid

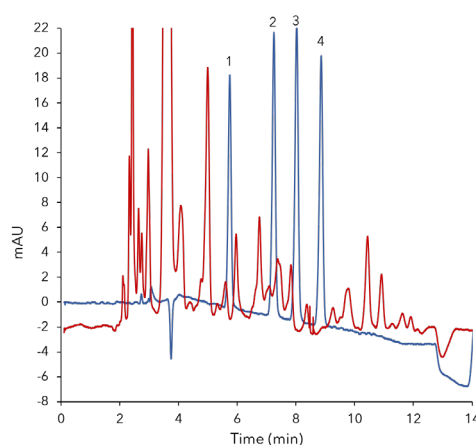

Fig. 2 Overlay of standard at 2.5 $\mu\text{g/mL}$ (blue) and cleaned sample of fruit blossom honey (red)

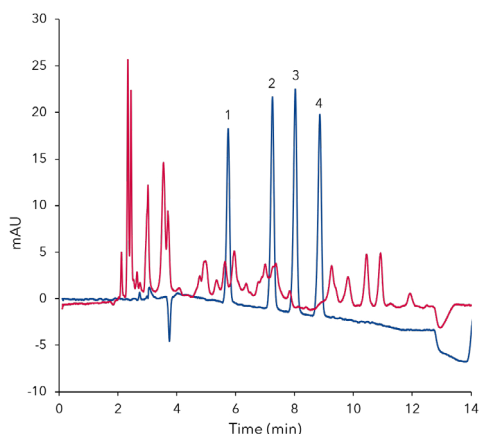

Fig. 3 Overlay of standard at 2.5 $\mu\text{g/mL}$ (blue) and cleaned sample of KNAUER honey (red)

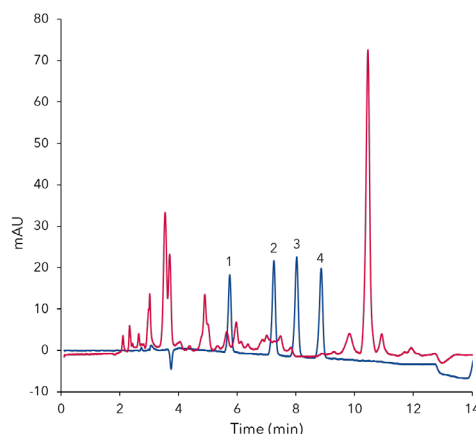

Fig. 4 Overlay of standard at 2.5 $\mu\text{g/mL}$ (blue) and cleaned sample of fruit blossom

MATERIALS AND METHODS

The application was performed on an AZURA HPLC Plus System equipped with an AZURA P 6.1L HPG pump, AZURA CT 2.1 column thermostat, AZURA autosampler AS 6.1L and AZURA DAD 6.1L detector. The mobile phase was a composition of acetonitrile and water, both containing 0.1 % formic acid. The gradient method has a total run time of 15 minutes including equilibration. The flow rate was set to 1 mL/min. Temperature was set to 30 °C and detection was carried out at 260 nm with a data rate of 20 Hz. For the sample preparation BEKOlut QuEChERS Citrate-Kit-01 and PSA-Kit-02 were used. The QuEChERS extraction protocol is described in the additional results section. The used column in a dimension 250 x 4.6 mm ID was filled with Eurospher II 100 5 C18P silica.

REFERENCES

- [1] https://ec.europa.eu/food/plant/pesticides/approval_active_substances/approval_renewal/neonicotinoids_en
- [2] Codling, G., et al. Concentrations of neonicotinoid insecticides in honey, pollen and honey bees (*Apis mellifera* L.) in central Saskatchewan, Canada, *Chemosphere*, Volume 144, 2016, Pages 2321-2328, ISSN 0045-6535, <https://doi.org/10.1016/j.chemosphere.2015.10.135>.
- [3] https://ec.europa.eu/food/plant/pesticides/approval_active_substances/approval_renewal/neonicotinoids_en
- [4] Official Journal of the European Union, L 132, 30 May 2018, <https://eur-lex.europa.eu/legal-content/EN/TXT/?uri=OJ:L:2018:132:TOC>
- [5] Commission Regulation (EU) 2017/671 of 7 April 2017 amending Annex II to Regulation (EC) No 396/2005, <http://data.europa.eu/eli/reg/2017/671/oj>
- [6] Commission Regulation (EU) No 491/2014 of 5 May 2014 amending Annexes II and III to Regulation (EC) No 396/2005, <http://data.europa.eu/eli/reg/2014/491/oj>
- [7] Commission Regulation (EU) 2017/626 of 31 March 2017 amending Annexes II and III to Regulation (EC) No 396/2005, <http://data.europa.eu/eli/reg/2017/626/oj>
- [8] Regulation (EC) No 396/2005 of the European Parliament and of the Council of 23 February 2005, <http://data.europa.eu/eli/reg/2005/396/oj>

CONCLUSION

Using QuEChERS extraction for sample preparation makes the handling of samples very easy and reduces time compared to e.g. solid phase extraction. Fortunately, neither the KNAUER honey nor the other tested samples were contaminated with neonicotinoids. Although banning neonicotinoids for the outside use, monitoring them is still mandatory. The developed method is suitable for quality control of honey or other apiculture products.

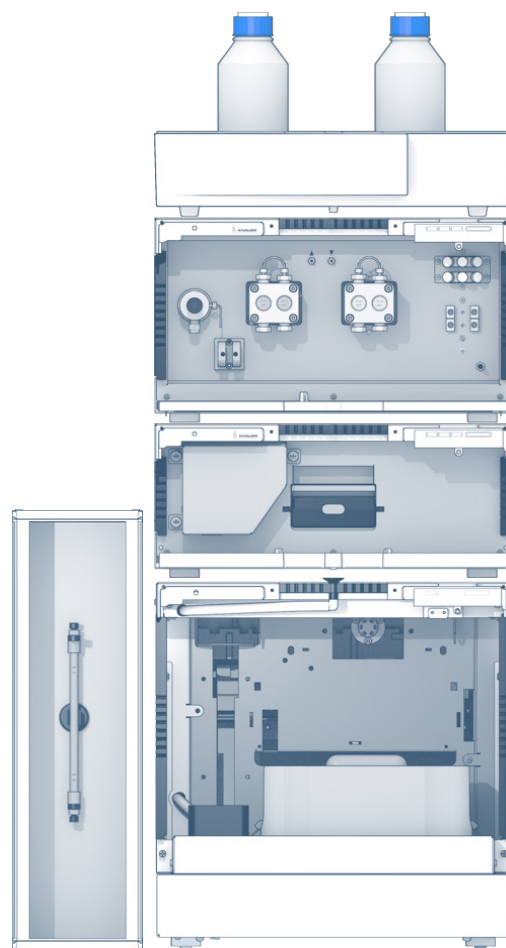

ADDITIONAL RESULTS

Tab. A1 LOD and LOQ values for single compounds

Compound	LOD (S/N=3) in ng/mL	LOQ (S/N=10) in ng/mL
Thiamthoxam	52.5	175.1
Clothianidin	48.2	160.6
Imidacloprid	45.8	152.5
Acetamiprid	49.6	165.3

ADDITIONAL MATERIALS AND METHODS

Tab. A2 Method parameters

Eluent A	d_d H ₂ O + 0.1 % formic acid		
Eluent B	Acetonitrile + 0.1 % formic acid		
Flow rate	1 mL/min		
Pump program	Time (min)	% A	% B
	0	75	25
	8	65	35
	10	65	35
	10.02	75	25
	15	75	25
Column temperature	30°C	Injection volume	5 µL
Injection mode	Partial loop	Detection	UV 260 nm
Data rate	20 Hz	Time constant	0.05 s

Tab. A3 Sample preparation

Extraction	
Step 1	Weigh 10 g of honey sample into a 50 ml falcon tube
Step 2	Add 10 mL of deionized water, shake until honey is dissolved
Step 3	Add 10 mL of acetonitrile
Step 4	Add the contents of the BEKOLut Citrate-Kit-01 and shake for 1 minute
Step 5	Centrifuge samples at 4000 x g for 5 minutes
Clean-up	
Step 1	Transfer 3 mL of supernatant into a BEKOLut PSA-Kit-02 dispersive SPE tube
Step 2	Vortex the samples for 30 seconds
Step 3	Centrifuge samples at 4000 x g for 5 minutes
Step 4	Transfer purified supernatant into an appropriate vessel/vial

Tab. A4 System configuration

Instrument	Description	Article No.
Pump	AZURA P6.1L, HPG	APH35EA
Autosampler	AZURA AS 6.1L	AAA00AA
Detector	AZURA DAD 6.1L	ADC11
Flow cell	High Sensitivity KNAUER LightGuide UV Flow Cell Cartridge	AMD59XA
Column thermostat	AZURA CT 2.1	A05852
Column	KNAUER Vertex Plus column, Eurospher II 100-5 C18P, 250 x 4.6 mm ID	25EE182E2J
Software	ClarityChrom 7.4.2 - Workstation, autosampler control included ClarityChrom 7.4.2 - PDA extension	A1670 A1676

RELATED KNAUER APPLICATIONS

[VFD0161](#) - Determination of sugars in honey using HILIC separation and RI detection

[VFD0169](#) - Determination of sugars in honey - comparison of refractive index and light scattering detection

[VEV0012J](#) - Determination of Carbamate Insecticides by HPLC with post-column derivatization

Determination of six steviol glycosides using reversed phased HPLC and online SPE

Johannes Menke, Yannick Krauke, Juliane Böttcher, Kate Monks; applications@knauer.net
KNAUER Wissenschaftliche Geräte GmbH, Hegauer Weg 38, 14163 Berlin; www.knauer.net



SUMMARY

Steviol glycosides are the main sweetening compounds in *Stevia rebaudiana* and can be used as natural sugar substitutes, because they have a far higher sweetening power than normal sucrose or glucose. The sweetness is estimated to be about 400 times higher. This gradient method provides a fast determination of six steviol glycosides using reversed phase HPLC and UV detection. Furthermore, an automated matrix reduction is achieved by online SPE (solid phase extraction), speeding up sample preparation and guaranteeing a high sample throughput.

INTRODUCTION

For several years research has been undertaken to find sugar substitutes that are calorie free but have the same taste and properties as classic sugar, for diabetics and as part of a calorie-controlled diet. One popular substitute is the so-called "Stevia" which is a mixture of steviol glycosides isolated from the plant *Stevia Rebaudiana* (REF1). The steviol glycoside rebaudioside A is the main compound of interest as it is the sweetest and less bitter compound of the extract but often a mixture of rebaudioside A and stevioside is

found in the "Stevia" products. In addition, also other steviol glycosides like rebaudioside B, rebaudioside C, dulcoside A and steviolbioside are commonly present in stevia mixtures and were therefore also analytes of interest in the developed method, as they are not desired in finished products. A determination method for steviol glycosides in stevia samples, with partly automated sample preparation and matrix reduction could thus be used for an easy quality control of stevia food products.



Determination of six steviol glycosides using reversed phased HPLC and online SPE

RESULTS

A gradient method for six steviol glycosides was developed beforehand (application note [VFD0168](#)). For this method a manual SPE protocol was used which was then transferred to the online SPE approach. The online SPE method was previously applied in preparative HPLC (application note [VFD0171](#)). For the analytical method valve switching sequences, as well as washing and conditioning solutions, were adopted from the preparative method. An extract of dried stevia leaves was used as sample. The extraction was performed as described in the application note for the original analytical method ([VFD0168](#)) as

well as the 5-point calibration with mix-standard solutions of rebaudioside A, stevioside, rebaudioside C, dulcoside A, rebaudioside B and steviolbioside. The calibration was set for a range from 0.01 mg/mL to 0.15 mg/mL of each individual compound. The injection volume was 20 μ L in full loop mode.

The flow passing the SPE column was monitored to see the effect of the washing procedure (**Fig 1**). After 7 min the main column flow was directed to the detector by swit

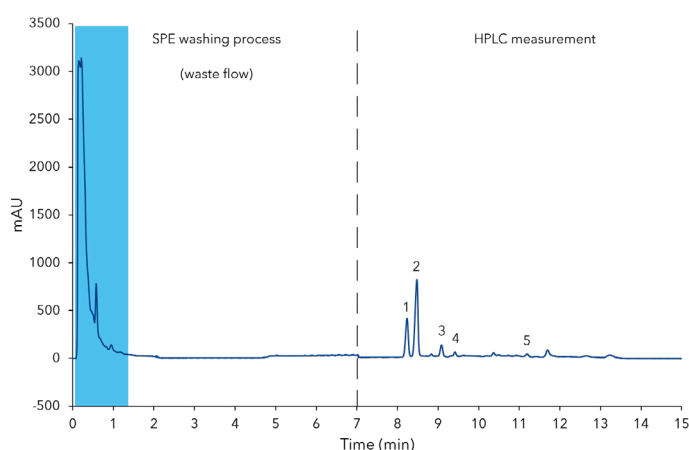

Fig. 1 Measurement of washing process; blue area: matrix; 1) rebaudioside A, 2) stevioside, 3) rebaudioside C, 4) dulcoside A, 5) steviolbioside; 20 μ L injection of Stevia extract; 0-7 min) measuring of SPE washing process, 7-15 min) measuring of HPLC

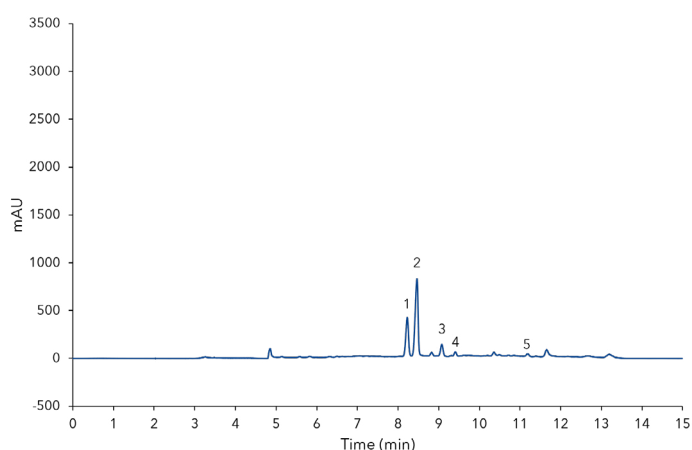

Fig. 2 Measurement of sample only; 1) rebaudioside A, 2) stevioside, 3) rebaudioside C, 4) dulcoside A, 5) steviolbioside; 20 μ L injection of Stevia extract

MATERIALS AND METHODS

As analytical system an AZURA Online SPE System equipped with an autosampler AS 6.1L, a binary high-pressure gradient pump P 6.1L with 10 mL pump head, a CT 2.1L column thermostat and a diode array detector DAD 2.1L was used as described in application note VFD0168. The SPE module of the system consists of an AZURA assistant ASM 2.1L equipped with a 12 port multi position 1/8" sst valve (solvent selection), a 6 port 2 position 1/16" sst injection valve, a P4.1S 50 ml sst feed pump. Injection was automated using an autosampler AZURA AS 6.1L. The eluent was a composition of A: water and B: acetonitrile and was also used to elute the analytes from the SPE column. As washing solution a premixed composition of 20:80 acetonitrile:water (v/v) was used. Conditioning of the column was performed with acetonitrile. A Vertex Plus column filled with Eurospher II 100-5 C18 silica in a dimension 250 x 4.6 mm ID with precolumn was used. For the SPE a column with the same material, but with dimension 30 x 4.6 mm ID was chosen. The sample was applied to an already conditioned and equilibrated SPE column, followed by a washing procedure. Next, elution on the SPE column is started by introduction of the water:acetonitrile gradient in reverse flow. Subsequently, the flow is then directed to the main column. Meanwhile the SPE column is conditioned and reequilibrated with washing solution using the feed pump.

REFERENCES

[1] "Stevia Leaf to Stevia Sweetener: Exploring Its Science, Benefits, and Future Potential" P. Samuel, K. T. Ayoob, B. A. Magnuson, et al. J Nutr, Volume 148, Issue 7, 1 July 2018, Pages 1186S-1205S

CONCLUSION

This method enhances the already fast and robust analysis of steviol glycosides provided by the previous HPLC method keeping all its advantages but adding the capabilities of online SPE. Thus, an easy matrix reduction can be achieved very fast only adding 3 minutes to the original runtime of 12 minutes. This automated matrix reduction saves up time otherwise needed for manual solid phase extraction and allows a high sample throughput. In addition, the analytical main column is spared from being exposed to high concentrations of matrix, enhancing the columns longevity. The monitoring of the washing process also easily allows an optimization of the process. Although the method is now extended to a runtime of 15 min, the overall process of stevia analysis was shortened by a great deal. Additionally, since the SPE column is conditioned for the next run meanwhile sample analysis thus saving even more time.

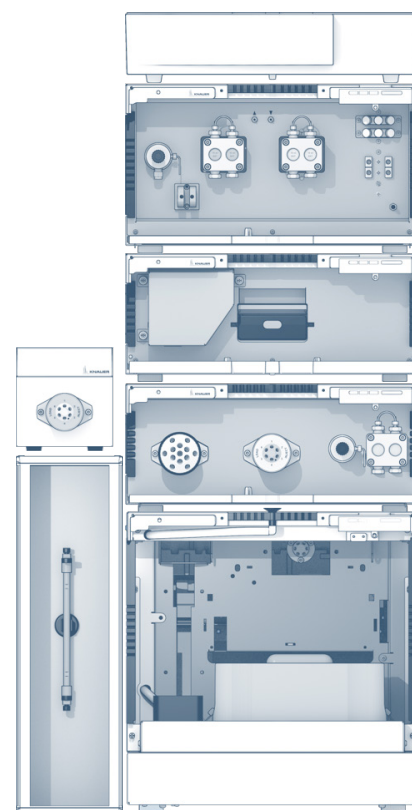

ADDITIONAL MATERIALS AND METHODS

Tab. A1 Method parameters (analytical method)

Column temperature	40 °C
Injection volume	20 µL
Injection mode	Full loop
Detection	UV 210 nm
Data rate	20 Hz

Tab. A2 Pump parameters (main pump)

Eluent A	ddH ₂ O		
Eluent B	Acetonitrile		
Flow rate	1.2 mL/min		
Pump program			
Time (min)	A [%]	B [%]	Flow [mL/min]
0	70.0	30.0	1.2
3	70.0	30.0	1.2
10	55.0	45.0	1.2
11	55.0	45.0	1.2
11.02	70.0	30.0	1.2
15	70.0	30.0	1.2

Tab. A3 Pump parameters (SPE assistant feed pump)

Eluent A	20:80 ACN:Water (v/v)
Pump program	
Time (min)	flow [mL/min]
0	2
2	2
2.02	0.5
9.98	0.5
10	2
15	2

Tab. A4 SPE assistant valve program

Time (min)	Valve left (Solvent selection)	Valve middle (Injection)
0	Pos 2: 20:80 ACN:Water (v/v)	Load
2	Pos 1: ACN	Inject
10	Pos 1: ACN	Load
12	Pos 2: 20:80 ACN:Water (v/v)	Load
15	Pos 2: 20:80 ACN:Water (v/v)	Load

Tab. A5 System configuration & data

Instrument	Description	Article No.
Pump	AZURA P6.1L (HPG) with 10 mL pump head sst	APH35EA
Autosampler	AZURA AS 6.1L	AAA00AA
Detector	AZURA DAD 2.1L	ADC01
Flow cell	Standard KNAUER LightGuide UV Flow Cell Cartridge 10mm, 2µL	AMC19XA
Thermostat	AZURA CT 2.1	A05852
Assistant	AZURA ASM 2.1L Left: 12 Mpos, 1/8", sst Middle: 6 Port 2Pos, 1/16", sst Right: P4.1S, 50 mL, sst	AYEKEABR
Valve Drive	AZURA Valve drive V 2.1S 6 Port 2Pos, 1/16", sst	AWA10AA
Column	Vertex Plus Column, Eurospher II 100 5 C18, 250 x 4.6 mm ID with precolumn Vertex Plus Column, Eurospher II 100 5 C18, 30 x 4.6 mm ID	25VE181E2N 03EE181E2J
Software	ClarityChrom 7.4.2 - Workstation. autosampler control included ClarityChrom 7.4.2 - PDA extension	A1670 A1676

RELATED KNAUER APPLICATIONS

[VFD0168](#) - Oh so sweet - Quantification of steviol glycosides in Stevia samples with RP-HPLC

[VFD0170](#) - Scale-Up of an analytical HPLC method for steviol glycosides to a preparative approach

[VFD0171](#) - Advantages of preparative online SPE compared to batch LC for stevia purification

[VFD0155](#) - Sensitive online SPE determination of Bisphenol A in water samples

Verification of the mycotoxin patulin from apple juice with isocratic HPLC

Kristin Folmert, Kate Monks; applications@knauer.net
KNAUER Wissenschaftliche Geräte GmbH, Hegauer Weg 38, 14163 Berlin; www.knauer.net



SUMMARY

The deleterious and mutagenic mould fungus product patulin can form during wrong cidermaking process of fruits like apple. The permitted daily exposure for patulin was declared as 0.05 µg/mL in apple juice by the scientific committee for foodstuffs of the European Commission. [1] The specified determination routines have to be performed with HPLC according to official guidelines. Here, a fast protocol for the determination of patulin from apple juice with AZURA® HPLC plus and a Eurospher II column is described.

INTRODUCTION

The lactone patulin belongs to the chemical group of polyketides. It is soluble in acidic water and many organic solvents like methanol. Different species of fungi, such as aspergillus, byssochlamys, and penicillium, growing on rotting parts of fruits including apples, cherries, plums, strawberries, blueberries and pears can produce the mycotoxin patulin. [2] Juices can be contaminated with patulin if affected fruits are used for the cidermaking process. As a result of its thermal stability, patulin cannot be destroyed by pasteurization or thermal denaturation. Next to its antibiotic qualities, patulin is implicated as a possible carcinogen but the toxicity of patulin is primarily

through its affinity to sulfhydryl groups which results in inhibition of enzymes. [3] Major acute toxicity findings include gastrointestinal problems, neurotoxicity, pulmonary congestion, and edema. [3] To protect customers from patulin in juices like apple juice, the FDA and the European Commission (EU) recommend a maximum daily ingestion concentration of 0.4 µg/kg body weight for humans according to 93/5/EWG and 0.05 µg/mL in apple juice per day. Furthermore, the EU has set a limit of 25 µg/kg in solid apple products and 10 µg/kg in baby food (2003/598/EG). [1]

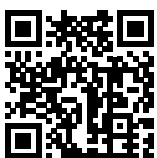

Verification of the mycotoxin patulin from apple juice with isocratic HPLC

RESULTS

The very fast and robust method with AZURA HPLC plus for the identification of patulin in juices like apple juice enables the validation of the concentration according to the regulation of the EU and FDA and at lower concentrations. The minimum concentration, which was measured with a 50 μL injection was 0.05 $\mu\text{g}/\text{mL}$ apple juice with a signal to noise ratio (S/N) of 216.4. The low noise value of 50 μAu enables a detection of

patulin at the limit of quantification (LOQ) with a concentration of 0.003 $\mu\text{g}/\text{mL}$. The short retention times of hydroxymethylfurfural (HMF) and patulin enable a high efficiency for the analysis. A good separation from all matrix peaks ($R_s > 1.5$) comfortably assures the quality of the measurements, as shown in **Fig 2 A** for the concentration of 0.25 $\mu\text{g}/\text{mL}$ patulin and HMF.



Fig. 1 Patulin contamination in apple juice

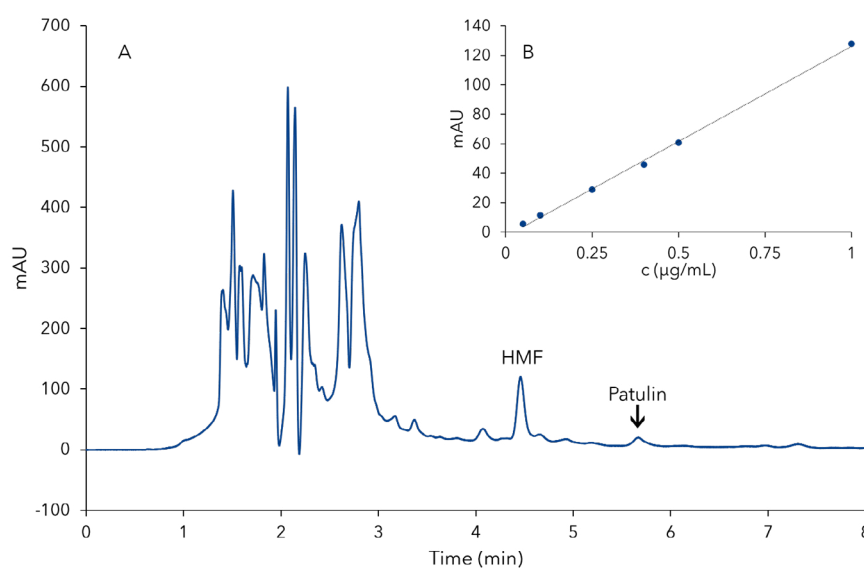

Fig. 2 Chromatogram of 50 μL injections from apple juice concentrate spiked with 0.25 $\mu\text{g}/\text{mL}$ patulin and HMF (A) and an concentration curve of patulin with the same injection volume (B). Concentrations of 1.00 $\mu\text{g}/\text{mL}$, 0.50 $\mu\text{g}/\text{mL}$, 0.40 $\mu\text{g}/\text{mL}$, 0.25 $\mu\text{g}/\text{mL}$, 0.10 $\mu\text{g}/\text{mL}$ and 0.05 $\mu\text{g}/\text{mL}$ patulin (n=3) for the concentration curve

MATERIALS AND METHODS

An AZURA HPLC plus system with the possibility to cool the autosampler rack to restore the quality of the food samples and a DAD detector with booster flow cell to monitor impurities at different wavelength was used to develop a simple and fast isocratic method. The eluent was a mixture of 10 % acetonitrile in water. The separation was realized within 7 minutes and with a phenyl endcapped Eurospher II 100-5 Phenyl column at an ambient temperature of 40°C. Therefore, 10 mL of gravy juice were mixed with 600 µL Pectinase enzyme and incubated at 37°C for 3 h before centrifuged at 3500 U/min for 10 min. After removing the centrifugate, the liquid was centrifuged again with the same conditions. The now concentrated apple juice is prepared for HPLC analysis. For the measurements in **Fig 2 A**, the concentrated juice was mixed with a standard solution of HMF and patulin to gain a concentration of 0.25 µg/mL. To evaluate the concentration in apple juice a concentration curve between 0.05 µg/mL to 1 µg/mL of patulin was measured using a standard of patulin in water (**Fig 2 B**).

REFERENCES

- [1] 2003/598/EG, Amtsblatt der Europäischen Union zur Prävention und Reduzierung der Patulinkonzentration in Apfelsaft und Apfelsaftzutaten in anderen Getränken, 2003, L203/54. <https://eur-lex.europa.eu/legal-content/DE/TXT/PDF/?uri=CELEX:32003H0598&from=EN>
- [2] G. C. Llewellyn, J. A. McCay, R. D. Brown, D. L. Musgrove, L. F. Butterworth, A. E. Munson, Jr. K. L. White, Immunological evaluation of the mycotoxin patulin in female B6C3F1 mice. *Food Chem. Toxicol.* 1998, 36, 1107-1111.
- [3] O. Puel, P. Galtier, I. P. Oswald, Biosynthesis and Toxicological Effects of Patulin, *Toxins*, 2010, 2 (4): 613-631.

CONCLUSION

A fast and efficient HPLC method was realized with AZURA HPLC plus and an isocratic method in only 7 minutes retention time. The cooling possibility of the autosampler elongates the life time of sensitive food samples and a column thermostat enables a continuous separation atmosphere above room temperature, which is crucial for the high robustness of the method. With these advantages the identification of patulin from apple juice can be realized down to the very low concentration of 0.003 µg/mL, which is 16 times less than the recommended maximum daily ingestion concentration for humans according to 2003/598/EG of the EU.

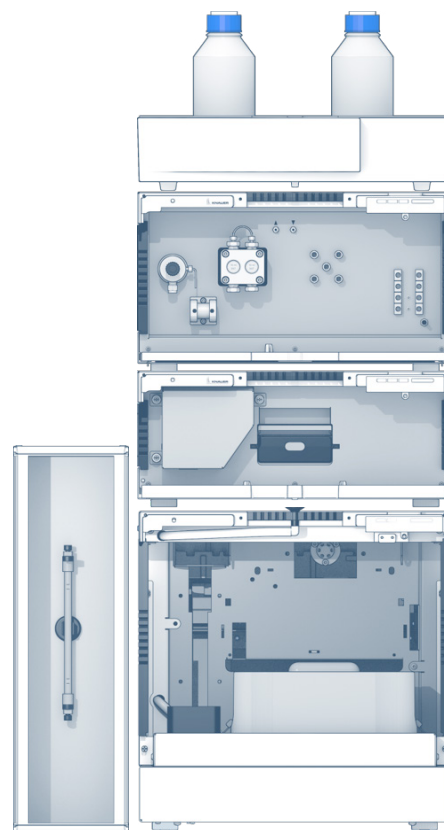

ADDITIONAL MATERIALS AND METHODS

Tab. A1 Method parameters

Eluent	ACN: _{dd} H ₂ O/1:9 (v:v)		
Flow rate	1 mL/min		
Column temperature	40°C	Injection volume	50 µL
Autosampler temperature	4°C	Injection mode	Full loop
Detection	275 nm	Data rate	10 Hz
		Time constant	0.1 s

Tab. A2 Instrument set up

Instrument	Description	Article No.
Pump	AZURA P6.1L, LPG	APH34EA
Autosampler	AZURA AS 6.1L	AAA01AA
Detector	AZURA DAD 6.1L	ADC11
Flow cell	LuightGuide 50 mm	AMD59XA
Column thermostat	AZURA CT 2.1	A05852
Column	KNAUER Vertex Plus column, Eurospher II 100-5 Phenyl, 150 x 4.6 mm	15VE050E2J
Software	ClarityChrom 7.4.2 - Workstation, autosampler control included ClarityChrom 7.4.2 - PDA extension	A1670 A1676

RELATED KNAUER APPLICATIONS

[VFD0042J](#) - Analysis of Flavonoids in Fruit Juice

[VFD0002J](#) - Determination of Naringine and Hesperidine in Fruit Juices

[VFD0152](#) - Determination of Aflatoxin M1 in Milk

Purification of epigallocatechin gallate and other related polyphenols from green tea by mass-triggered fractionation

Jan Wendrich, Maria Glanz, Kate Monks - applications@knauer.net
KNAUER Wissenschaftliche Geräte GmbH,
Hegauer Weg 38, 14163 Berlin - www.knauer.net



SUMMARY

Epigallocatechin gallate is one of the major metabolites in green tea material and has shown positive effects on human health in several studies. This target molecule was isolated together with three other polyphenolic compounds in a short time with an AZURA® Preparative HPLC system using mass-triggered fractionation. The number of fractions was reduced to a minimum by this technique leading to a significant decrease in past analysis time showing that mass-directed purification is the ideal method in the isolation of natural products.

INTRODUCTION

Catechins are polyphenolic metabolites that appear in plants. These molecules from the group of flavonoids gained a lot of interest over the past decades due to their antioxidant properties. Especially, epigallocatechin gallate was subjected to intensive research regarding its positive effects on human health. It

can be purchased as a dietary supplement but is also available in high amounts in green tea leaves. Here, we present an easy and time-saving method for the isolation of epigallocatechin gallate and other related catechins from a green tea extract based on the technique of mass-triggered fractionation.

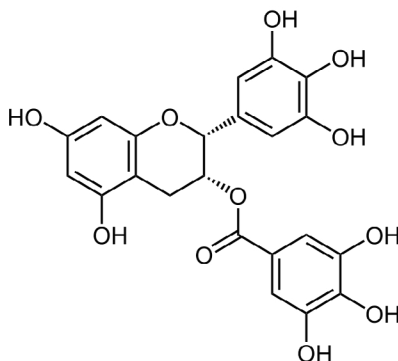

Structure of Epigallocatechin gallate (Catechin)

Purification of epigallocatechin gallate and other related polyphenols from green tea by mass-triggered fractionation

RESULTS

A method for the isolation of epigallocatechin gallate from green tea extract was developed on analytical scale using an AZURA Analytical HPLC plus system and an Eurospher II C18 column (Fig. 1). The developed method was then transferred to the AZURA Preparative system with the ability to fractionate via molecular mass (Fig. 2). One fraction with the desired mass for epigallocatechin gallate (m/z 457.4; $[M-H]^-$) was collected (Fig. 3). In addition to this fraction, three further

fractions corresponding to epicatechin, epicatechin gallate and epigallocatechin (m/z 289.2; m/z 305.2; m/z 441.4; $[M-H]^-$) were collected. The following HPLC analysis of the target fraction showed that it was possible to isolate epigallocatechin gallate with the technique of mass-triggered fractionation with a purity of >95 % (Fig. 4). Also, three other catechins were isolated by this method in the purity of >90 % (Fig. A1-A3).

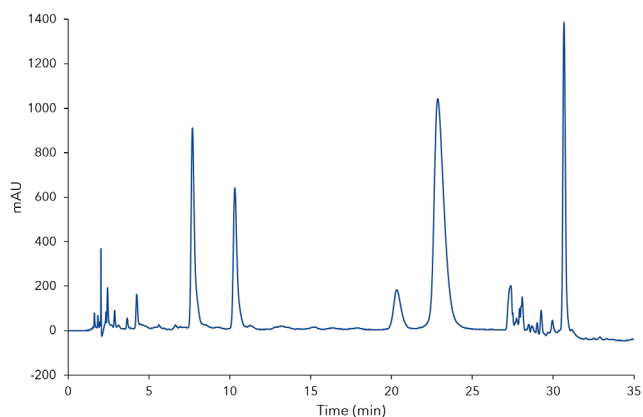

Fig. 1 Analytical chromatogram of the crude green tea extract at 220 nm; step gradient separation 10 % acetonitrile until 26 min, then 15 % acetonitrile

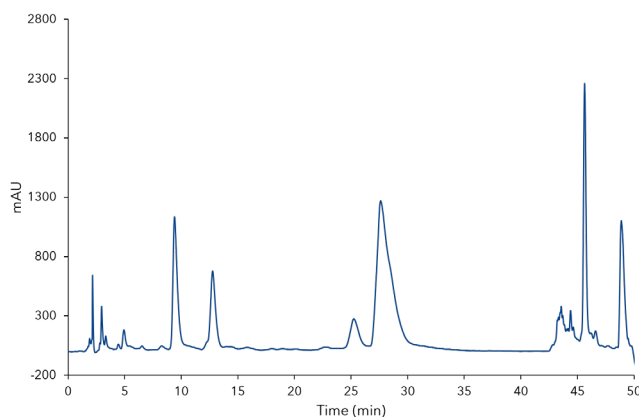

Fig. 2 UV chromatogram of a purification run for the crude green tea extract at 220 nm

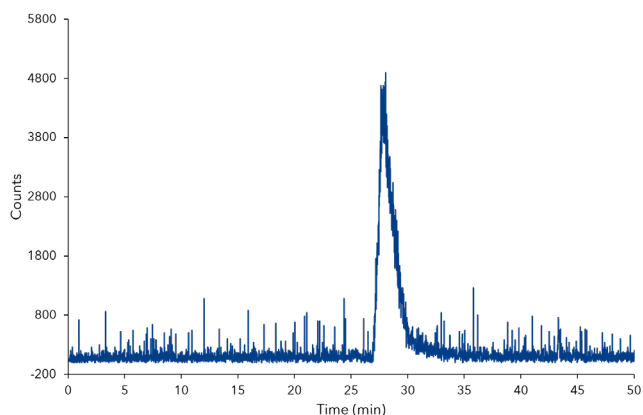

Fig. 3 SIM (single ion monitoring) chromatogram of a purification run for the target mass of m/z 457.4

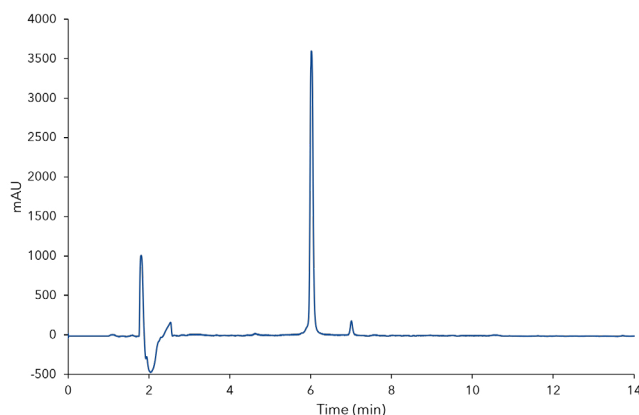

Fig. 4 Analytical chromatogram of the third fraction containing epigallocatechin gallate (m/z 457.4; $[M-H]^-$); linear gradient separation 5 %-50 % acetonitrile

MATERIALS AND METHOD

AZURA Analytical HPLC Plus system was used for the method development. Method optimization on this analytical system led to a step gradient, which was used for the isolation of polyphenols from green tea.

AZURA Preparative HPLC system was used for the mass-directed purification of epigallocatechin gallate. The system consisted of an AZURA P 2.1L pump equipped with a 250 mL pump head and a three channel low pressure gradient (LPG) ternary module, a manual injection valve (1/8", 6 port 2 position) equipped with a 5 mL sample loop, an AZURA UVD 2.1S detector equipped with a 3 mm flow cell, a 4000 MiD mass spectrometer with the MiDas sampling unit, a Foxy R1 fraction collector and an Eurospher II 100-5

C18 150 x 20 mm column. The step gradient method run for 50 min at a flow rate of 18.9 ml/min with the following composition: 0 min 10%B, 40 min 10%B, 40.1 15%B, 50 min 15%B, with 0.1% formic acid in water (A) and acetonitrile (B) as eluents. The wavelength of the detector was set to 220 nm at a data rate of 10 Hz, while the mass selective detector was set to negative SIM mode monitoring the masses of m/z 289.2, 305.2, 441.4, 457.4.

The green tea extract was prepared by sonification of ground green tea leaves with 75% ethanol for 60 min, followed by filtration and the dilution in a ration of 1:1 with water.

CONCLUSION

Epigallocatechin gallate is one of the major metabolites in green tea. This target molecule was isolated together with three other polyphenolic compounds in a short time with an AZURA Preparative HPLC system using the technique of mass-triggered fractionation. The number of fractions was reduced to a minimum by this technique leading to a significant decrease in past analysis time.

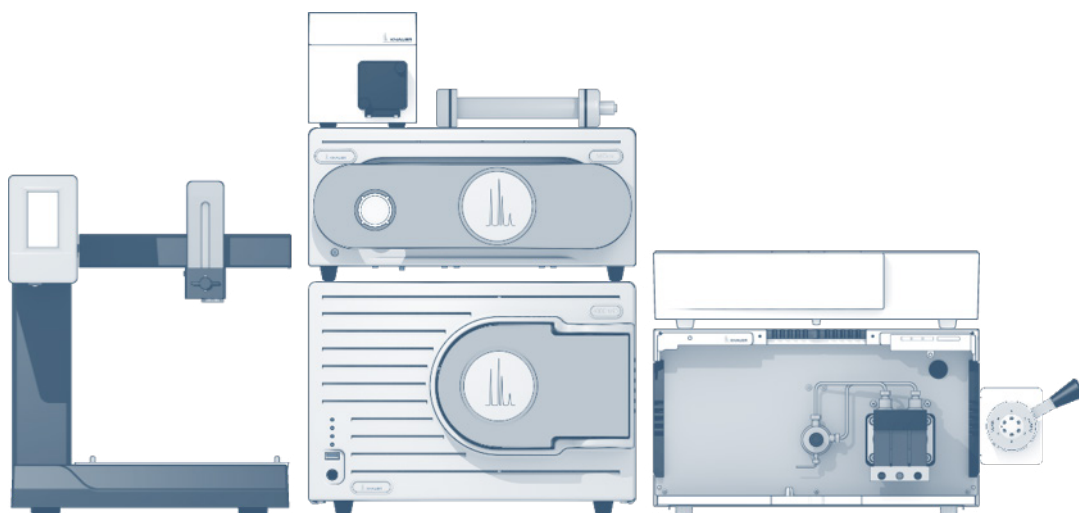

ADDITIONAL RESULTS

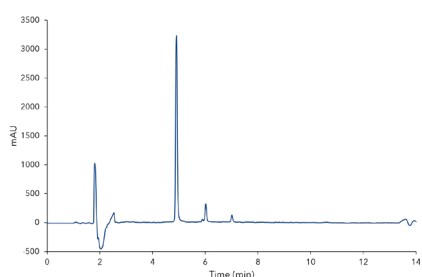

Fig. A1 Analytical chromatogram of the first fraction containing epigallocatechin (m/z 305.2; [M-H]); linear gradient separation 5%-50% acetonitrile.

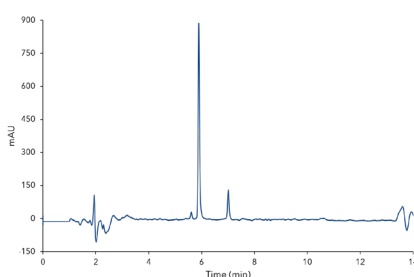

Fig. A2 Analytical chromatogram of the second fraction containing epicatechin (m/z 289.2; [M-H]); linear gradient separation 5%-50% acetonitrile.

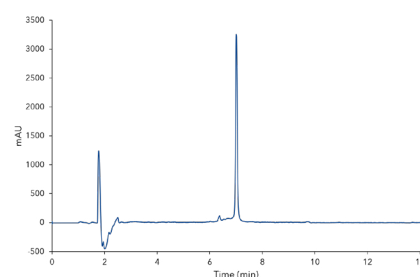

Fig. A3 Analytical chromatogram of the fourth fraction containing epicatechin gallate (m/z 441.4; [M-H]); linear gradient separation 5%-50% acetonitrile.

ADDITIONAL MATERIALS AND METHODS

Tab. A1 Method parameters (preparative)

Eluent A	Water + 0.1% formic acid		
Eluent B	Acetonitrile		
Gradient	Time (min)	%A	%B
	0	90	10
	40	90	10
	40.1	85	15
	50	85	15
Flow rate	18.9 mL/min	System pressure	120 bar
Column temperature	RT	Run time	50 min
Injection volume	500 µL	Injection mode	-
Detection wavelength	220 nm	Data rate	10 Hz
		Time constant	0.1 sec

Tab. A3 System configuration & data (analytical system)

Instrument	Description	Article No.
Pump	AZURA P 6.1L	APH34GA
Autosampler	AZURA AS 6.1L	AAA00AA
Detector	AZURA DAD 2.1L	ADC01
Flow cell	PressureProof flow cell 10 mm, 10 µl	AMC38
Column	Eurospher II 100-5 C18 with precolumn, Vertex Plus Column 150 x 4.6 mm	15VE181E2J
Software	ClarityChrom	A1670
	ClarityChrom 8.1 - PDA extension	A1676

Tab. A2 Method parameters (mass spectrometer)

Scan mode	SIM (Single Ion Monitoring)
Scan rate	1 Hz
Step	0.2
SIM	289.2 m/z, 305.2 m/z, 441.4 m/z, 457.4 m/z
Ion mode	Negative
Gas flow	2.5 l/min

Tab. A4 System configuration & data (preparative system)

Instrument	Description	Article No.
Pump	AZURA P 2.1L	APE20LA
	AZURA LPG module for Pump P 2.1L	AZZ00AB
Injection	AZURA V 2.1	A1359
Sample loop	5 ml sample loop	A0586-2
Detector	AZURA UVD 2.1S	ADA00
Flow cell	Semi-preparative UV flow cell 3 mm, 2 µl	A4042
Mass spectrometer	4000 MiD with MiDas	A66900
Fractionation	Fraction collector Foxy R1	A59100
Column	Eurospher II 100-5 C18, Column 150x20 mm	15JE181E2J
Software	PurityChrom 5.9.69	A2650
	PurityChrom Upgrade to full version	A2652
	PurityChrom MS license	A2655

RELATED KNAUER APPLICATIONS

[VPH0067](#) - Easy and fast isolation of rosmarinic acid from lemon balm with mass-directed purification

Quick and easy determination of aflatoxins in food matrices with photochemical post column derivatization

Kristin Folmert, Mareike Margraf, Kate Monks - applications@knauer.net
KNAUER Wissenschaftliche Geräte GmbH,
Hegauer Weg 38, 14163 Berlin - www.knauer.net



SUMMARY

One of the 10 most dangerous chemicals in the world is the aflatoxin B1. For both, humans and animals the consumption of the toxic aflatoxins can lead to serious health damage. They are produced by mold fungi on food and feed products. Herewith, a simple, robust and highly sensitive method for the analysis of aflatoxins in food and feed is provided to ensure consumer safety.

INTRODUCTION

Aflatoxins are the best known group of mycotoxins produced as secondary metabolites by fungi, mainly by *Aspergillus flavus* and *Aspergillus parasiticus*, but to a smaller extent also by other strains. [1] Aflatoxins can be produced on crops in the field or during storage of agricultural products, especially under warm conditions and high humidity. Aflatoxins also pose a significant economic burden, causing an estimated 25 % or more of the world's food crops to be destroyed annually. [2] Unfortunately, these substances can persist long after the fungi have been killed and then contaminate foods. Most mycotoxins are stable compounds that are also not destroyed during food processing or cooking. Although a large number of aflatoxins exist only a limited number is important in analytical practice. Aflatoxin B1 is most widespread and can be found in food and feed products such as peanuts, pistachios, corn and cottonseed, dried fruits, and all processed products. It is highly toxic and the WHO classified it as a group 1 carcinogen. [2] The aflatoxins B2, G1, and G2 are usually found accompanying B1 in lower concentrations in the contaminated

samples (**Fig. 1**). Governmental institutions and health protection agencies like FDA, WHO and European Commission apply these methods on a large scale to control marketed food products and animal feed. [2, 3, 4] Additionally, the presence of aflatoxins B1, B2, G1, and G2 in a variety of processed and unprocessed foods is controlled in countries around the world. 0.1 µg/kg processed cereal-based foods and all kinds of dietary foods for special medical purpose, both for babies, infants and young children is the lowest maximum aflatoxin level set by the European Commission according to regulation EG 1881/2006. [5] The required verification method is HPLC with fluorescence detection and preliminary sample extraction described in the KNAUER application notes VFD0179-VFD0182. Unfortunately, Aflatoxins B1 and G1 show only minimal fluorescence and are thus difficult to detect. Irradiating the aflatoxin mixture with UV light of 254 nm, the aflatoxins B1 and G1 undergo photo-induced hydroxylation and can then be measured through fluorescence spectrometry more sensitively.



Quick and easy determination of aflatoxins in food matrices with photochemical post column derivatization

RESULTS

For the method development of an universally usable aflatoxin HPLC method an equal mixture of food extracts was produced. The mixture contained extracts from different nuts, dried fruits, and cereal baby food products. Nuts are the most often affected source of aflatoxins, while dried fruits are the most difficult matrix for the analysis. Cereal puree and rusk for babies are prominent examples for the food group with lowest accepted action levels defined by the European Commission. The resulting gradient method takes 9 minutes followed by a 6 minute long column cleaning and equilibration step (Fig. 2). The resulting peak resolution for the aflatoxin peaks was higher than 1.5 and all matrix peaks could be separated. The determined limits of detection (LOD) were 0.05 ng/mL for aflatoxins B1/G1 and 0.015 ng/mL for B2/G2 (Fig. 3). These values are 3.4 and 11.3 times lower than requested by the European Commission [5]. To evaluate the quality of the developed method, the recovery (W), the standard deviation (RSD), and the robustness were established. The recovery ratios were determined with three repetitions at three concentration levels. The used limits were the limit of qualification (LOQ), twice the LOQ and 20 ng/mL. The results in Tab. 1 are an average of the three concentration limits. At the high level the

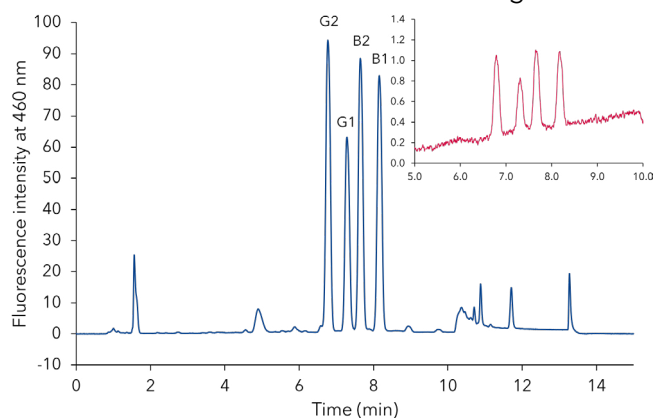

Fig. 2 Chromatogram of a mixture including equal parts of extraction products from peanuts, pistachios, cereal puree and rusk for babies and dried fruits (cherries, cranberries, raisins, aronia, and plums) spiked with 20 ng/mL of the aflatoxins B1/G1 and 6 ng/mL B2/G2 (blue). Zoom into a chromatogram of a standard mixture of the four aflatoxins at the LOQ (red).

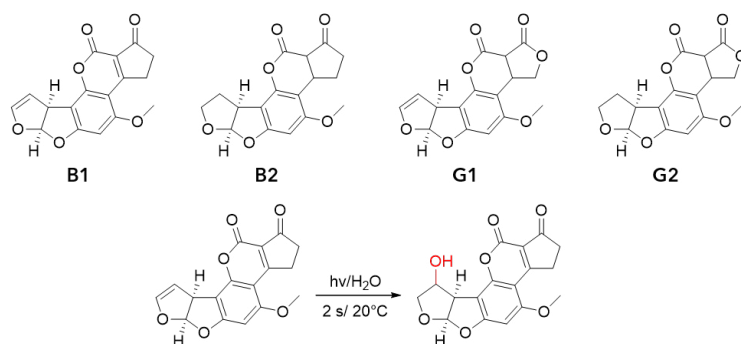

Fig. 1 Chemical structures of the four aflatoxins and the reaction mechanism of the photochemical activation

recovery was around 100 % with decreasing quality for the very low concentrations, which is reasonable due to the volume of the derivatization reaction coil. For the standard deviation 8 identical repetitions with 1 ng/mL of an aflatoxine standard mixture were measured (Tab. 2). The RSD was lower 0.1 % for the retention times and lower 0.5 % for the peak area and height. For robustness evaluation a variation of the method parameters was performed (Tab. 3). The method was assumed to be robust if all matrix peaks and the four aflatoxin peaks were baseline separated from each other. The developed aflatoxin method resulted to be very robust against changes in temperature, flow rate and the eluent mixture during the gradient.

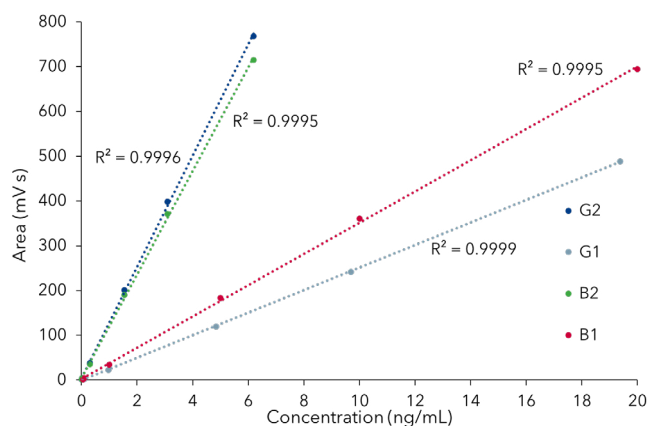

Fig. 3 Concentration curves for the four aflatoxins with correlation coefficient. The empiric determined LOD for the aflatoxins B1/G1 was 0.05 ng/mL and for B2/G2 0.015 ng/mL.

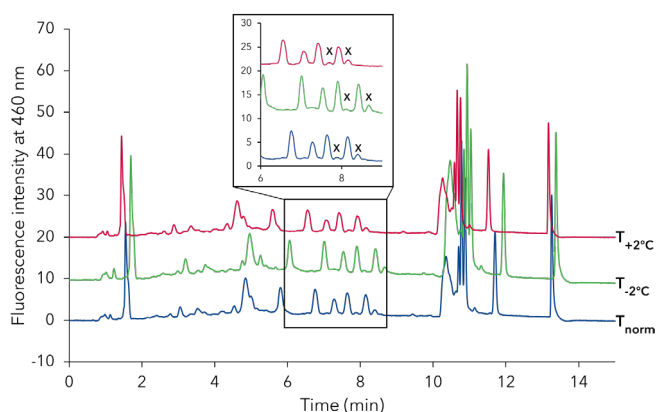

Fig. 4 Example of three chromatograms with 1.0 ng/mL aflatoxin B1/G1 and 0.3 ng/mL B2/G2 measured for robustness validation. The method was robust if the two labeled matrix peaks were baseline separated from the aflatoxin peaks.

MATERIALS & METHODS

The dedicated AZURA® Aflatoxin system consisted of a low pressure gradient AZURA P 6.1L pump, an AZURA autosampler AS 6.1L, an AZURA CT 2.1 column thermostat, and an RF-20A fluorescence detector with coupled photochemical post column derivatization module. The photochemical post column derivatization enables a non-toxic and fast derivatization at room temperature. In comparison to previous methods, using saturated iodine reaction coils or with electrochemical generated bromine in a KOBRA cell, no toxic halogenic reagents were used for derivatization. Thus, no halogenic solvent waste was produced. The column was a temperature and mechanical robust Eurospher II C18 100-3 column. The sample preparation was performed with liquid-liquid and solid phase extraction as described in the KNAUER application notes [VFD0179](#), [VFD0180](#), [VFD0181](#), and [VFD0182](#).

REFERENCES

- [4] M.T. Hedayati, A.C. Pasqualotto, P. Bowyer, D.W. Denning, *Microbiology* 2007 (153) 6, 1677-1692. doi: 10.1099/mic.0.2007/007641-0
- [5] World Health Organization, *Food Safety Digest - Aflatoxins*, Department of Food Safety and Zoonoses 2018, Ref. No.: WHO/NHM/FOS/RAM/18.1.
- [6] U.S. Department of Health and Human Services, Food and Drug Administration, Sec.683.100 Action Levels for Aflatoxins in Animal Food 2019.
- [7] Die Europäische Gemeinschaft, Verordnung (EG) Nr. 401/2006 Der Kommission - Zur Festlegung der Probennahmeverfahren und Analysemethoden für die amtliche Kontrolle des Mykotoxingehalts von Lebensmitteln 2016.
- [8] The European Commission, Commission Regulation (EC) No 1881/2006 of 19 December 2016 - Setting maximum levels for certain contaminants in foodstuffs, *Official Journal of the European Union*, 2006, L 364/5 - L 364/24.

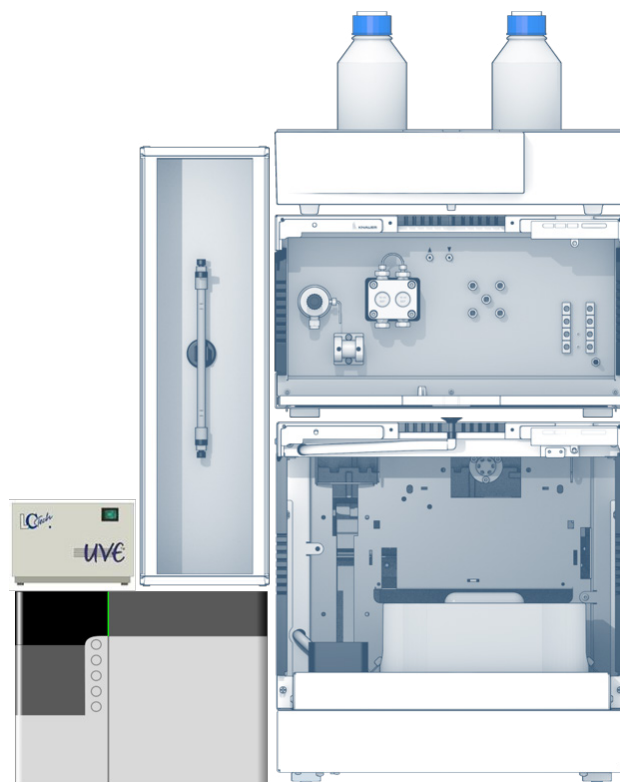

DISCUSSION

Using the UVE photochemical reactor for post column derivatization in combination with the AZURA Analytical HPLC system and Eurospher II C18 column, it was possible to detect the four aflatoxins B1, B2, G1 and G2 in one chromatographic run with the very low LOD of 0.05 ng/mL for B1/G1 and 0.15 ng/mL for B2/G2. The high robustness and reproducibility of the method were confirmed by empirical quality control. Furthermore, the handling of the photochemical reactor was very easy because no further chemicals were required for derivatization.

ADDITIONAL RESULTS

Tab. A1 Averaged recovery ratios measured at LOQ, twice LOQ and 20 ng/mL aflatoxin

Aflatoxin	W (%)
B1	80 ± 6
B2	78 ± 5
G1	87 ± 7
G2	84 ± 6

Tab. A2 Standard deviation (RSD) of 8 repetitions at the same conditions

Parameter	RSD (%)
Retention time	< 0.1
Peak area	< 0.5
Peak height	< 0.5

Tab. A3 Robustness of the method

Parameter	Robust range
Temperature	± 2°C
Flow rate	± 0.2 mL/min
tG ACN	± 2%
tG MeOH	± 2%
tG H ₂ O	± 2%

ADDITIONAL MATERIALS AND METHODS

Tab. A4 Instrument setup

Column temperature	60°C	Time constant	0.1 s
Injection volume	10 µL	Excitation	365 nm
Injection mode	Full Loop	Emission	460 nm
Detection	FLD	Post column derivatization	254 nm
Data rate	50 Hz	Flow rate	2.4 mL/min

Tab. A5 Pump program

Time (min)	Water (%)	ACN (%)	MeOH (%)
0	83.0	5.0	12.0
0.5	83.0	5.0	12.0
9.0	54.0	34.0	12.0
9.1	0.0	100.0	0
12.0	0.0	100.0	0
12.1	83.0	5.0	12.0
15.0	83.0	5.0	12.0

Tab. A6 System configuration

Instrument	Description	Article No.
Pump	AZURA P6.1L, LPG	APH39EA
Autosampler	AZURA AS 6.1L	AAA00AA
Fluorescence detector	RF-20A	A59200
Thermostat	AZURA CT 2.1	A05852
Column	Eurospher II C18 100-3 150-4.6 mm	15EE181E2G
Post column derivatization	UVE Box, 50 Hz	A07547
Interface box	IFU 2.1 Lan	AZB00XA
Software	ClarityChrom 8.1	A1670

RELATED APPLICATIONS

[VFD0179](#) - Determination of Aflatoxines in Peanut Samples - From Extraction to High Efficient Detection

[VFD0180](#) - Determination of Aflatoxines in Pistachio Samples - From Extraction to High Efficient Detection

[VFD0181](#) - Determination of Aflatoxines in Dried Fruit Samples - From Extraction to High Efficient Detection

[VFD0182](#) - Determination of Aflatoxines in Cereal Baby Food Samples - From Extraction to High Efficient Detection

Quantitative determination of gallic acid and tannic acid from gallnut extract



Juliane Böttcher, Kate Monks; applications@knauer.net

KNAUER Wissenschaftliche Geräte GmbH, Hegauer Weg 38, 14163 Berlin; www.knauer.net

SUMMARY

Quercus infectoria gallae (oak gall) contain tannins which are characterized to have curative and anti-inflammatory properties. Because of their antiviral and antibacterial qualities, tannins from gallnut extracts have been used in traditional and ayurvedic medicine as well as beauty culture. A newly developed gallnut extract was prepared in a glycerin-water-mixture. To examine the quality of this extract a reliable, innovative HPLC method was worked out to determine the containing active ingredients.

INTRODUCTION

Tannins or tanning agents are natural occurring phenolic plant compounds highly abundant in bark, roots, and leaves. Their main operation area is to support the healing process of inflammations, abscesses, incinerations, wounds [4], atopic skin [6], as well as quinsy [1, 5]. The effect of tannins is antibacterial, antiviral [2], antifungal [3] anti-inflammatory, astringent and toxin neutralizing. Tanning agents are divided into three groups: gallotannins, algae tanning agents and catechol tanning agents. Gallic acid, also known as 3,4,5-trihydroxybenzoic acid, is a component of the gallotannins and found highly concentrated in

gallnuts and oak bark. Tannic acid is a specific commercial form of tannin. The chemical formula for tannic acid is often given as $C_{76}H_{52}O_{46}$, which corresponds with decagalloyl glucose, but in fact it is a mixture of polygalloyl glucoses or polygalloyl quinic acid esters with a varying number of galloyl moieties per molecule. The following application shows how to determine and quantify gallic acid and tannic acid from gallnut extract with an HPLC method. Since tannic acid was defined as a mixture its determination was carried out as a sum parameter.



Quantitative determination of gallic acid and tannic acid from gallnut extract

RESULTS

For the quantitative determination of gallic acid and tannic acid five different measuring points were defined. After calibration the limit of detection (LOD) and the limit of quantification (LOQ) were determined. For gallic acid a LOD of 12 ng/mL and LOQ of 40 ng/mL was achieved. For tannic acid a LOD of 120 ng/mL and LOQ of 400 ng/mL was calculated. The next step was to measure the sample. The gallnut extract consist of a mixture of glycerol and water and had a strong yellow, almost brown dye. Because of the extract's viscosity a direct injection into the HPLC system was not possible. A dilution series was made and a final dilution with water in a relation of 1:1000 was chosen. The extract was filtered through a 0.45 μm pore size hydrophilic

filter. For the evaluation of gallic acid and tannic acid pretreated samples with different injection volumes were measured. Gallic acid was analyzed with an injection volume of 10 μL whereas an injection volume of 1 μL was used for determining the sum parameter tannic acid. **Fig 1 and 2** show the measurements of the diluted extract at different injection volumes. Furthermore replicates of the filtered and diluted (1:1000) extract were measured with 1 μL and 10 μL injection volume. The samples are evaluated on the based calibration curves. The replicates show reproducible results. Relating to the detected area the relative standard deviation for the measurements ($n=4$) is 1.94 % RSD for gallic acid and 0.51 % RSD for tannic acid.

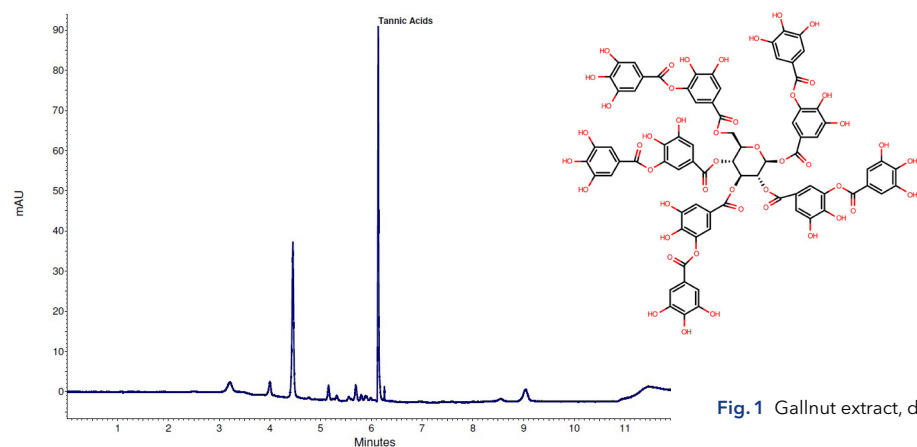

Fig. 1 Gallnut extract, dilution 1:1000, 1 μL injection.

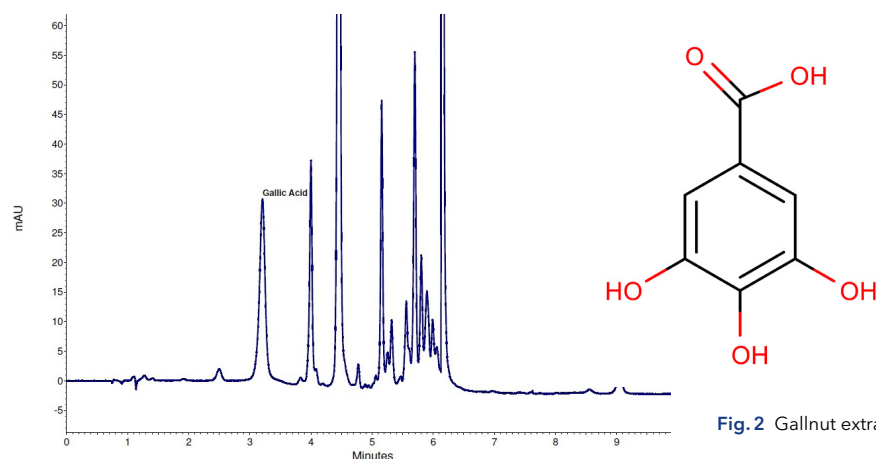

Fig. 2 Gallnut extract, dilution 1:1000, 10 μL injection

MATERIALS AND METHODS

An AZURA Analytical HPLC Plus system for a pressure range up to 700 bar was used for this application. It consists of a P 6.1L HPG pump, an autosampler 3950, a CT 2.1 column thermostat and DAD 6.1L. The analytical method runs with a gradient mode at a flow rate of 1 mL/min. The mobile phase is a mixture of water and acetonitrile/water 50:50 (v/v). An amount of 0.1 % of formic acid is used as mobile phase modifier. The column thermostat was set to 30 °C and the detector recorded at 280 nm. The used column is filled with Eurospher II 100-3 C18H silica.

CONCLUSION

With this developed method and the AZURA® HPLC Plus system it is possible to perform a rapid quantitative analysis of gallic acid and tannic acid without time-consuming sample preparation. Despite of the complex matrix like the gallnut extract, the quantification could be performed robustly and reproducibly with the specified method parameters. To exploit the full potency of gallic acid a preparative purification of the extract is possible. For the processing of the purified product it has to be solved in glycerol, water or a mixture of those solvents. Because of the presence of acidic modifier and methanol in the analytical method it cannot be adapted directly up to a preparative dimension. A possible preparative method should be applied immediately after the gallnut extraction and should be run with 100 % watery eluent. KNAUER's developed analytical method still can be used for quality and purity control.

REFERENCES

- [1] Savitri Shrestha, Vasuki Srinivas Kaushik, Ravi Shankara Birur Eshwarappa, Sundara Rajan Subaramaihha, Latha Muuaiah Ramanna, and Dhananjaya Bhadrappura Lakkappa, *Asian Pac J Trop Biomed.* 4(1): 35-39, 2014 Jan.
- [2] Kyoko Ueda, Ryoko Kawabata, Takashi Irie, Yoshiaki Nakai, Yukinobu Tohya, Takemasa Sakaguchi, *PLoS ONE* 8(1): e55343, 2013.
- [3] Nur Saeida Baharuddin, Hasmah Abdullah, Wan Nor Amilah Wan Abdul Wahab, *J Pharm Bioallied Sci.* 7(1): 15-20, 2015 Jan-Mar.
- [4] Umachigi SP, Jayaveera KN, Ashok Kumar CK, Kumar GS, Vrushabendra swamy BM, Kishore Kumar DV, *Tropical Journal of Pharmaceutical Research:* 7 (1): 913-919, March 2008.
- [5] Upadhye AS, *Pharm Anal Acta.* , 2010.
- [6] Jung MK, Hur DY, Song SB, Park Y, Kim TS, Bang SI, Kim S, Song HK, Park H, Cho DH, *J Invest Dermatol.* 130(5):1459-63., 2010 May.



ADDITIONAL RESULTS

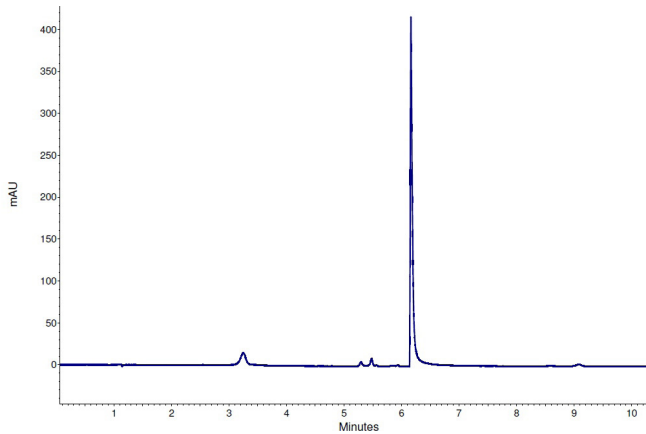

Fig.A1 Chromatogram Gallic acid, $\beta=0.01$ mg/mL

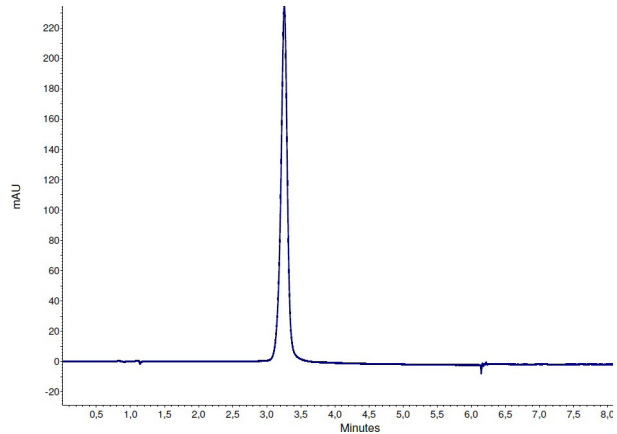

Fig.A2 Chromatogram Tannic acid, $\beta=0.01$ mg/mL

ADDITIONAL MATERIALS AND METHODS

Tab.A1 Method parameters

Eluent A	H ₂ O _{dd} +0.1 % formic acid		
Eluent B	Acetonitrile: H ₂ O _{dd} 50:50 (v/v) +0.1 % formic acid		
Gradient	Time [min]	% A	% B
	0.00	95	5
	2.00	95	5
	5.00	55	45
	5.02	0	100
	10.00	0	100
	10.02	95	5
	15.00	95	5
Flow rate	1 mL/min	System pressure	-
Column temperature	30 °C	Run time	15 min
Injection volume	1-10 μ L	Injection mode	-
Detection wavelength	280 nm	Data rate	20 Hz
		Time constant	0.05 sec

Tab.A2 System configuration & data

Instrument	Description	Article No.
Pump	AZURA P 6.1L, HPG, 10 mL, SS	APH35EA
Autosampler	Autosampler 3950	A50070
Detector	AZURA DAD 6.1L	ADC11
Flow cell	LightGuide 50mm, 6 μ L	AMD59
Thermostat	AZURA CT 2.1	A05852
Eluent tray	AZURA E 2.1L	AZC00
Column	Vertex Plus Column, 150x3mm, Eurospher II 100-3 C18H	15XE185E2G
Software	OpenLAB CDS EZChrom Edition	A2600-1

Quality control of pharmaceutical solutions by determination of osmolality

Juliane Böttcher, Till Myrach, Kate Monks; applications@knauer.net
KNAUER Wissenschaftliche Geräte GmbH, Hegauer Weg 38, 14163 Berlin; www.knauer.net



SUMMARY

The osmolality of solutions used in the clinical and pharmaceutical field is an important issue that requires regular monitoring. Especially infusion solutions but also solutions for external use like eye drops and rinsing solutions must be isotonic to ensure the physical well-being of humans. In this study, the osmolality of commercially available pharmaceutical solutions were determined using the KNAUER K-7400S Semi-Micro Osmometer.

INTRODUCTION

To guarantee the quality of solutions used for pharmaceutical or medical purposes the osmolality is consulted as an assessment value. The osmolality is a general measure for the number of solved molecules in a liquid and is commonly given in mOsmol/kg. Conventionally used solutions for clinical application are for example Ringer solution [1], physiological salt solution (0.9 % NaCl), and 5 % glucose. These have to be in the osmolality range of 290 ± 10 mOsmol/kg to

comply with human plasma [2]. In addition to these physiological infusions also glucose solutions of higher concentration (10 %, 15 % and 20 %) are used in daily clinical practice. These are for instance applied for the treatment of hypoglycemic conditions or as carbohydrate component in parenteral nutrition [3]. All of the mentioned solutions were prepared and analysed to evaluate their actual osmolalities.



Quality control of pharmaceutical solutions by determination of osmolality

RESULTS

To evaluate the results, they were divided into the different fields of application. On the one hand the isotonic solutions used for infusion or rinsing, and on the other hand the glucose solutions with varying concentrations for special treatments. The 5 % glucose solution is somehow an exception and could be applied for both ambits. The diagram in **Fig 1** shows the measurement of the isotonic solutions in relation to

the given limit value for plasma. The averaged osmolality (n=10) for Ringer solution was 284 mOsmol/kg, 281 mOsmol/kg for 0.9 % NaCl and 287 mOsmol/kg for 5 % glucose. The diagram in **Fig 2** visualizes the measured osmolalities of different glucose solutions with concentrations of 5 %, 10 %, 15 % and 20 % glucose. The determined averaged osmolality (n=10) added up to 604 mOsmol/kg for 10 %

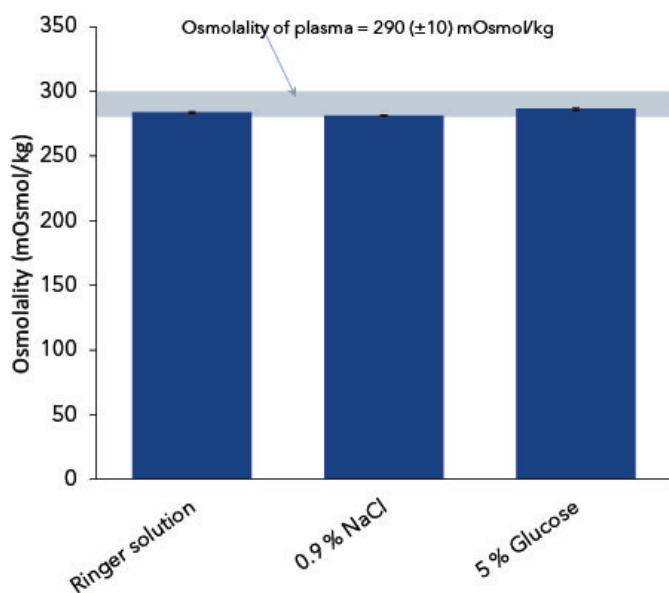

Fig. 1 Measured osmolalities of pharmaceutical infusion solutions. Graph shows average values and standard deviations of 10 replicates.

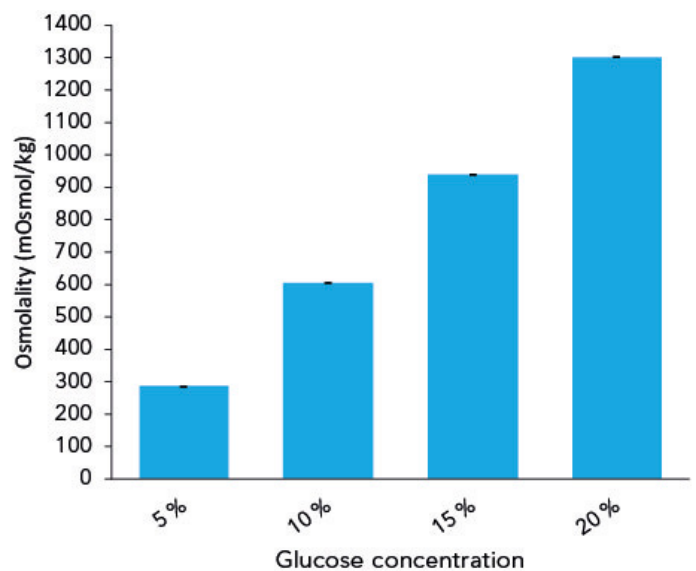

Fig. 2 Measured osmolalities of different glucose solutions. Graph shows average values and standard deviations of 10 replicates.

MATERIALS AND METHODS

All measurements were made with the KNAUER K-7400S Semi-Micro Osmometer. The used calibration standards had osmolality values of 300, 400, 850, and 2000 mOsmol/kg. The system parameters were set to -8 °C for freeze and -16 °C for cooling limit. All prepared solutions were degassed using an ultrasonic bath to remove the carbon dioxide. Then 150 µL of the samples were transferred to a plastic sample tube.

CONCLUSION

The measured results for all isotonic solutions are within the given limit value for human plasma of 290 ± 10 mOsmol/kg. This is interesting as most manufacturers of pharmaceutical solutions only state the theoretical osmolalities of their products. The theoretical osmolality of physiological salt solution is specified as 308 mOsmol/kg. However, as shown in the analysis, the real osmolality is clearly lower (281 mOsmol/kg). Especially for more complex infusion solutions, a verification of the real osmolalities is therefore highly recommended since the deviation to the theoretical value might be even higher. Unless there are no limit values of osmolality for higher concentrated glucose solutions, the measurements can be used as a good example to show that the comportment of osmolality is not linear.

REFERENCES

- [1] <http://flexikon.doccheck.com/de/Ringer-L%C3%B6sung>
- [2] <https://www.gesundheit.gv.at/labor/laborwerte/niere-harn/osmolalitaet>
- [3] <https://www.serag-wiessner.de/fileadmin/redakteur/PDF/informationen/I3714AAF.pdf>



ADDITIONAL RESULTS

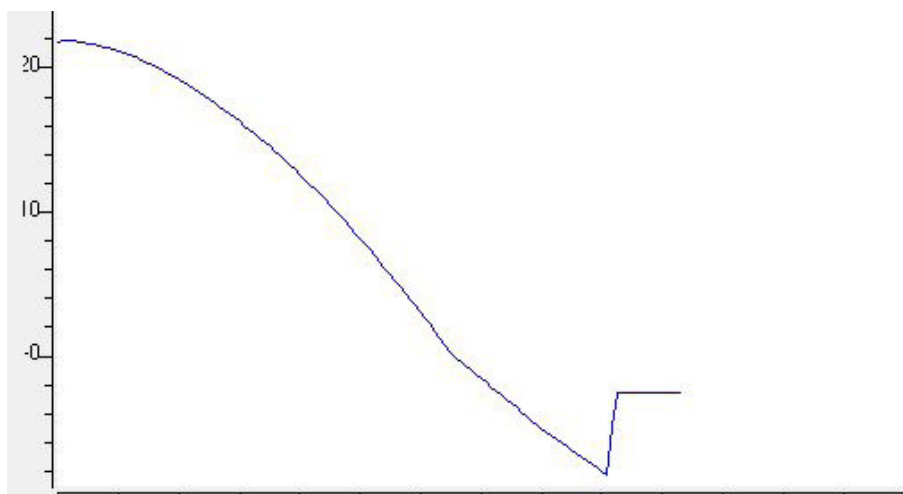

Fig.A1 Temperature-time-curve

ADDITIONAL MATERIALS AND METHODS

Tab.A1 Method parameters

Calibration 1	0 mOsmol/kg	300 mOsmol/kg	400 mOsmol/kg
Calibration 2	0 mOsmol/kg	300 mOsmol/kg	850 mOsmol/kg
Calibration 3	0 mOsmol/kg	850 mOsmol/kg	2000 mOsmol/kg
Sample volume	150 µL		
Freeze	-8 °C		
Cooling limit	-16 °C		

Tab.A2 System configuration & data

Instrument	Description	Article No.
Osmometer	KNAUER K-7400S Semi-Micro Osmometer	A0006AC
Sample tubes	Approved plastic sample tubes, 500 pcs.	A0272
Software	EuroOsmo 7400	A3705

RELATED KNAUER APPLICATIONS

[VPH0064](#) - Quality control of pharmaceutical solutions by determination of osmolality

Traditional Chinese Medicine meets modern analytics - HPLC fingerprinting for the comparison of *Radix paeonia alba* and *Radix paeonia rubra*

Juliane Böttcher, Kate Monks; applications@knauer.net
KNAUER Wissenschaftliche Geräte GmbH, Hegauer Weg 38, 14163 Berlin; www.knauer.net



SUMMARY

In Traditional Chinese Medicine (TCM) *Radix paeonia alba* (white peony root) and *Radix paeonia rubra* (red peony root) are important herbs used in many different preparations. [1] To ensure the identification of both cultivations an HPLC fingerprint was developed to work out the differences between red and white peony root products.

INTRODUCTION

White (Bai shao) and red peony root (Chi shao) belong to the Paeoniaceae family, so both are variants of the same species. Red peony root is gathered in the wild while the white peony root is cultivated. The Chinese names do not refer to the color of the bloom but to the color of the root. The main functions of Chi shao in TCM practices are the removal of pathogenic heat from blood and invigorate blood to remove blood stasis. Its most important uses and indications are for example measles in epidemic heat syndrome, hematemesis, nosebleed, discharging fresh blood stool, sore red swollen eyes, swelling, abscesses and boils, and many more. The usual dosage is from 6 to 12 grams,

generally in decoction [2]. The white peony root is best used as a tonic for blood and as a “heat reducing” (or “heat removing”) herb for the liver. According to Traditional Chinese Medicine methodology and theory, white peony root for instance helps with abdominal pain and muscular spasms. The benefits continue: Chinese medicine practitioners also believe it also has an astringent effect on sweating, and is also antibacterial, antispasmodic, and anti-inflammatory in nature. [3] Because of having different superior benefits, a specific differentiation is important to gain a proper application of these herbal medicines.

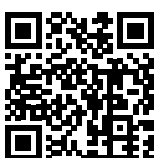

Traditional Chinese Medicine meets modern analytics – HPLC fingerprinting for the comparison of *Radix Paeonia alba* and *Radix Paeonia rubra*

RESULTS

Samples of peony root have been analyzed to differ between red and white peony extracts of plant origin. Furthermore, extracts of peony granulate were measured and compared to the plant origin samples to make statement about the affiliation to either *Radix Paeonia rubra* or *Radix Paeonia alba*. Additionally, the main active component paeoniflorin, which is present in both cultivations, was identified by the measurement of an analytical standard. **Fig. 1** shows an enhanced overlay of the plant origin extracts of *Paeonia rubra* and *Paeonia alba*. Paeoniflorin was detected at 13.40 minutes. The trace of *Paeonia rubra* shows a

characteristic peak at a retention time of 26 minutes, which is not found in the *Paeonia alba* sample. For a better peak identification in the samples the 3D data is also considered for evaluation. The absorption spectra of the tagged peaks are shown in the additional results section of this application note. **Fig. 2** shows an overlay of *Paeonia rubra* granulate and *Paeonia rubra* plant extract. Here a group of three peaks is found in the granulate but missing in the plant origin sample. Again, the recorded 3D data was used for examination. (see additional results section)

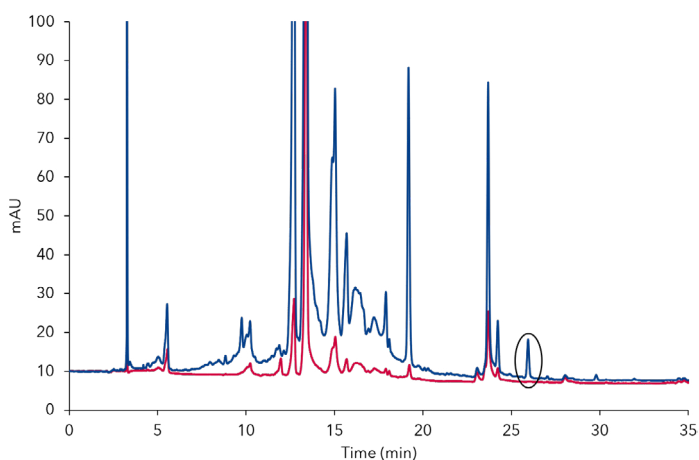

Fig. 1 Enhanced overlay of *Paeonia rubra* (blue) and *Paeonia alba* (red) plant extracts, tagged peak at 26 min

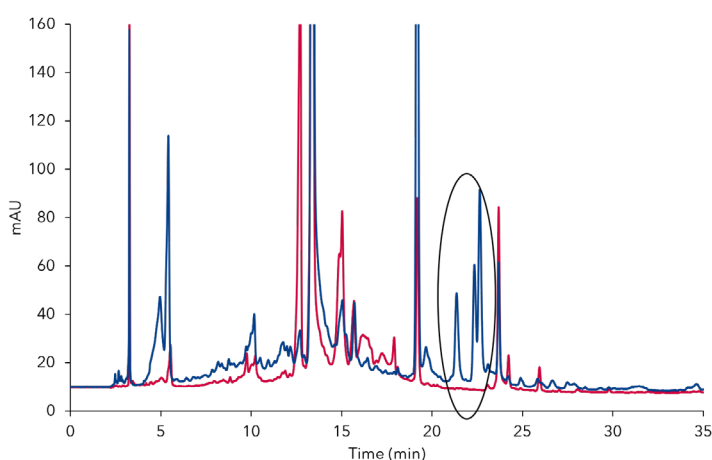

Fig. 2 Overlay *Paeonia rubra* granulate (blue) and *Paeonia rubra* plant extract (red), tagged peaks from 21.3 min to 22.7 min

MATERIALS AND METHODS

The analysis was performed using an AZURA HPLC Plus system consisting of an AZURA AS 6.1L autosampler, an AZURA CT 2.1 column thermostat, an AZURA P 6.1L LPG pump and an AZURA DAD 2.1L diode array detector equipped with 10 mm, 10 μ L PressureProof flow cell cartridge. The eluent was a composition of A: water + 0.05 % phosphoric acid and B: acetonitrile. A linear gradient was used with a total run time of 70 min including equilibration time. The column thermostat was set to 40°C. The traces were detected at 230 nm. Additionally, 3D data was recorded over a range from 190 nm to 700 nm. The samples were injected as ethanolic extracts. Before injection the samples were diluted with ethanol in a ratio of 1:10. The used column in a dimension 250 x 4.6 mm ID with precolumn was filled with Eurospher II 100-5 C18 P silica.

REFERENCES

[1] Chunnian H, Yong P, Yuxiong F, Bing P, Zhe W, Peigen X. Quick comparison of Radix Paeonia Alba, Radix Paeonia Rubra, and Cortex Moutan by high performance liquid chromatography coupled with monolithic columns and their chemical pattern recognition. *Pharmacognosy Magazine*. 2012;8(31):237-243. doi:10.4103/0973-1296.99290.

[2] <http://www.chineseherbshealing.com/red-peonies-chi-shao-yao/>

[3] <https://mydaolabs.com/blogs/the-way/white-peony-root-bai-shao>

CONCLUSION

The differentiation between the white and red peony root plant extracts is given, referring to the characteristic peak at a retention time of 26 minutes. Also, the difference between Paeonia rubra granulate and plant extract can also be determined via this method. The HPLC fingerprint profile of the Paeonia alba granulate and plant origin sample is very similar and only differs in the paeoniflorin concentration. A characteristic peak was not found here. However, as well the Paeonia rubra granulate as the Paeonia rubra plant extract show characteristics which are not found in the Paeonia alba samples. Therefore, a correlation of granulates and plant extracts to the cultivation is possible.

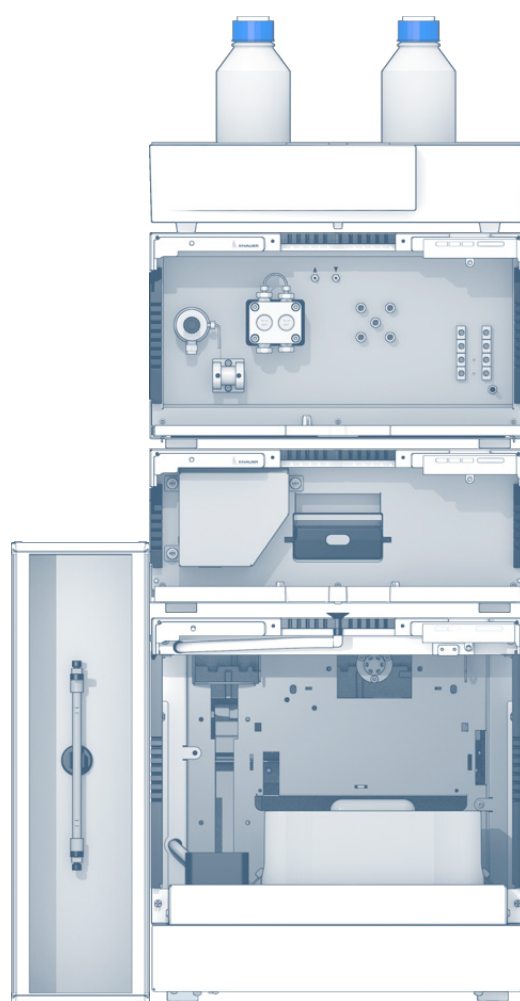

ADDITIONAL RESULTS

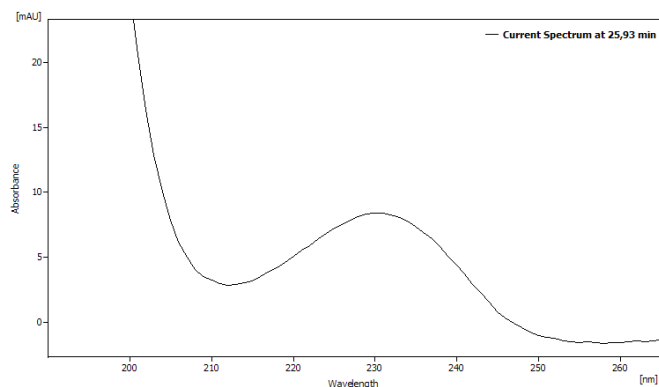

Fig.A1 Absorption spectrum of Paeonia rubra sample at 26 min

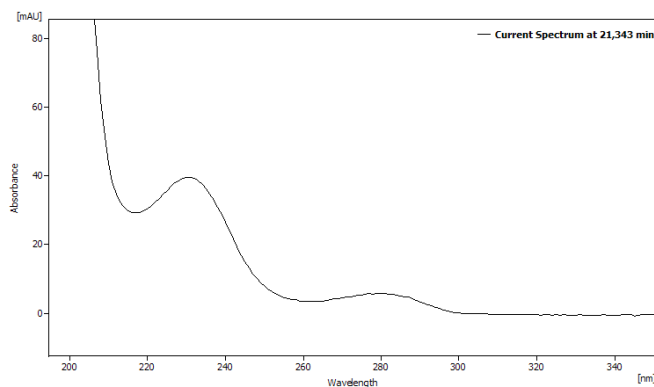

Fig.A2 Absorption spectrum of Paeonia rubra granulate at 21.34 min

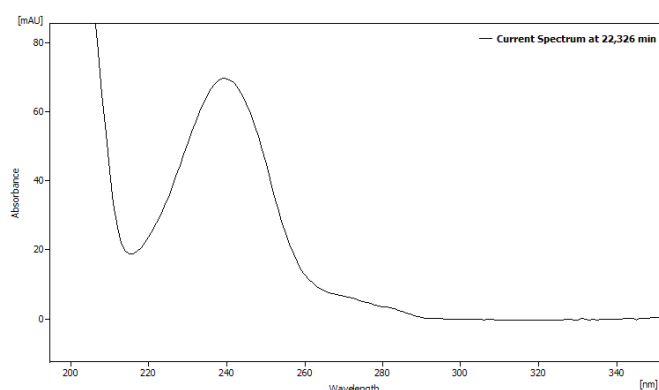

Fig.A3 Absorption spectrum of Paeonia rubra granulate at 22.30 min

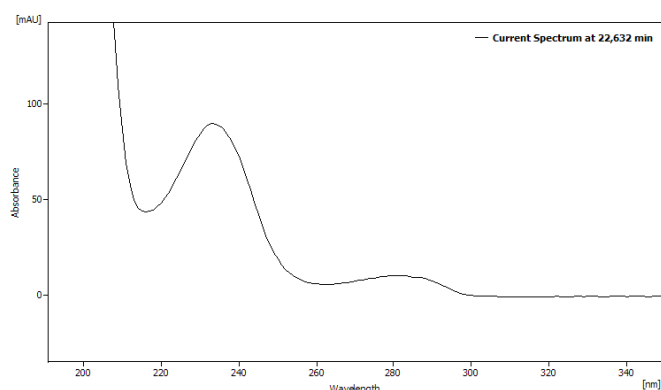

Fig.A4 Absorption spectrum of Paeonia rubra granulate at 22.60 min

ADDITIONAL MATERIALS AND METHODS

Tab.A1 Method parameters

Eluent A	Water + 0.05 % phosphoric acid		
Eluent B	Acetonitrile		
Gradient	Time [min]	% A	% B
	0	95	5
	60	0	100
	60.02	95	5
	70	95	5
Flow rate	1.0 mL/min	System pressure	100 bar
Run temperature	40°C	Run time	70 min
Injection volume	10 µL	Injection mode	Partial loop
Detection wavelength	230 nm	Data rate	20 Hz
		Time constant	0.05 s

Tab.A2 System configuration & data

Instrument	Description	Article No.
Pump	AZURA P 6.1L, LPG	APH39EA
Autosampler	AZURA AS 6.1L	AAA00AA
Detector	AZURA DAD 2.1L	ADC01
Flow cell	Analytical KNAUER PressureProof UV Flow Cell Cartridge, 10 mm, 10 µl	-AMC38
Column thermostat	AZURA CT 2.1	A05852
Column	Vertex Plus Column, Eurospher II 100-5 C18 P, 250 x 4.6 mm ID with precolumn	25VE182E2J
Software	ClarityChrom 7.4.2 - Workstation, autosampler control included ClarityChrom 7.4.2 - PDA extension	A1670 A1676

RELATED KNAUER APPLICATIONS

[VPH0063](#) - Quantitative determination of gallic acid and tannic acid from gallnut extract

[VPH0055J](#) - Determination of Ginsenosides (I)

[VFD0103J](#) - Separation of Bisabolol oxide A and B from Camellia extract

Cyclodextrin purification (Part 1): Method screening and overload studies

Yannick Krauke*, Sebastian Thürmann*, Christian Sonnendecker**,
Kate Monks* – applications@knauer.net

*KNAUER Wissenschaftliche Geräte GmbH, Hegauer Weg 38,
14163 Berlin – www.knauer.net

** Fakultät für Lebenswissenschaften / Institut für Biochemie AG
Mikrobiologie und Bioverfahrenstechnik,
Johannisallee 21-23, 04103 Leipzig

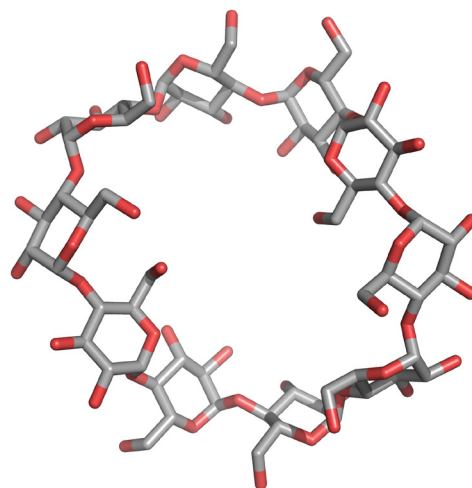

SUMMARY

Cyclodextrins (CD) are macrocyclic compounds composed of five or more glycopyranosides. These ring structures can function as micro-capsules. An automated column screening was applied for method development to find best separation conditions of a CD mixture. Finally, an optimized method for CD purification was established.

INTRODUCTION

Cyclodextrins (CD) are oligosaccharides of glucopyranose that are bound in a cyclic form of six to at least 12 units. The ring structure can function as micro-capsule for other molecules. Do to their unique chemical structure they can find different applications i. e. as drug carriers, in cosmetics or in food industry. CDs with more than 10 subunits are of special interest as larger molecules can be inserted in these rings.

Therefore, the approaches for synthesis and purification of CD >10 are conducted [1]. Here, a method optimization was performed for the purification of cyclodextrins from biocatalytic synthesis [2]. With an automated column screening an existing method was optimized. Further, mass- and volume overload studies were performed in analytical scale to find best conditions for scale-up to preparative scale.

Cyclodextrin purification (Part 1): Method screening and overload studies

RESULTS

A device with automated column switching valves was used for sequentially testing of four different stationary phases: C18, C18H, C18A und C18P each 150 x4 mm, 5 µm particles and 2.5 % methanol (Fig. A1, additional results). The C18 and C18H showed the best separation profile among tested columns. Separation with water on aqueous C18A and C18AP revealed no promising results.

Next, the columns length was investigated and revealed that the relevant peaks had a better separation factor on a 250 mm then 150 mm long columns (Fig. A2, additional results). The 150 mm length column is good for analysis but for preparative applications the 250 mm column is required.

Comparison of different methanol concentrations revealed that 5 % methanol was too high as nearly all peaks eluted together within the first 10 min (not shown). At 3 % methanol one additional peak (Fig. A3; CD13, additional results) was detected which was

not found at 2.5 % methanol on C18 column (Fig. A3), revealing that accurate eluent preparation is essential for this method.

The final separation profile comparison of the CDmix on C18 and C18H revealed that the C18H column is the better choice for purification of cyclodextrins due to earlier elution of target peaks (Fig. 1). Four relevant cyclodextrins were baseline separated (Fig. 1). A mass and volume overload studies were performed prior to preparative scale-up. Four different concentrations (25, 50, 75, 100 mg/mL) of the CD mix were tested and results showed that even at 100 mg/mL CD10, CD11 and CD12 were baseline separated (Fig. 2). Next, different volumes (50, 75, 100, 200 µL) of 50 mg/mL CD mix were injected. At 100 µL the first three peaks were still baseline separated, at 200 µL not as well anymore (Fig. 3). The resulting data was used to up-scale the separation for purification on columns with larger ID (see application Cyclodextrine purification - [VPH0068](#)).

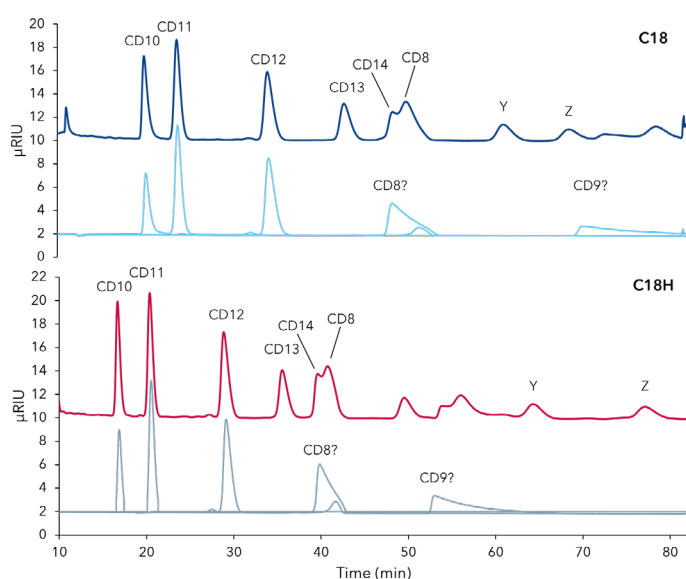

Fig. 1 Comparison of separation profiles from CD mixture and CD standards on C18 (dark blue) and C18H (red) columns (relevant time span of separation shown). CD mixture (30 mg/mL), CD8 (1 mg/mL), CD 12,9,8 mixture (3mg/mL), CD10, 11 mixture (2 mg/mL); Y, Z unidentified peaks; 250x4mm, 5 µm, 0.8 mL/min 3 % methanol, 50 µL inject

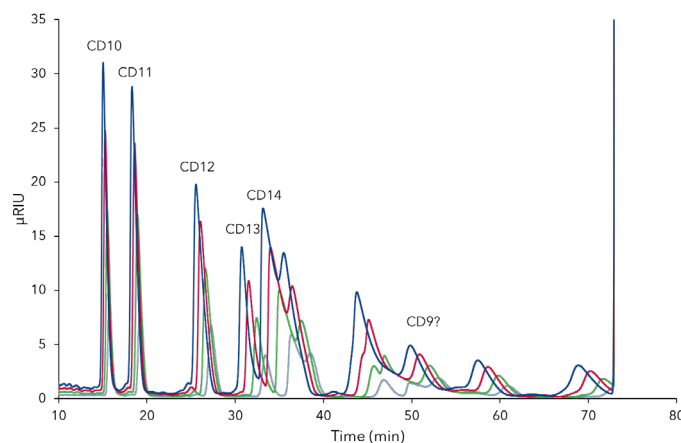

Fig. 2 Chromatograms of CD mixture mass overload studies; grey - 25 mg/mL, green - 50 mg/mL, red - 75 mg/mL, dark blue - 100 mg/mL; C18 H 250 x 4 mm; 5 µm; 0.8 mL/min; 3 % methanol; 25°C; 50 µL

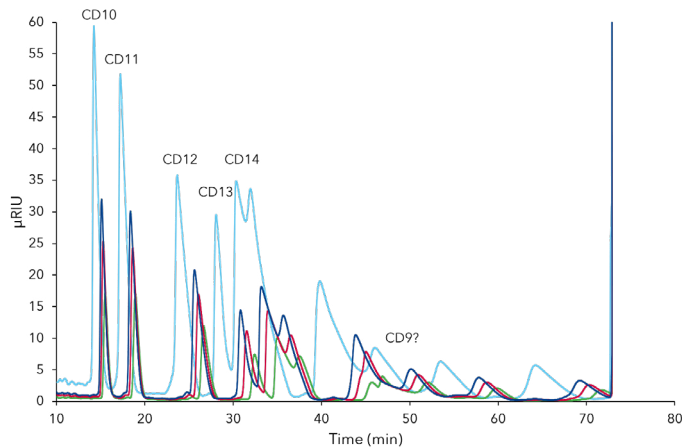

Fig. 3 Chromatograms of CDmix volume overload studies. green - 50 μ L, red - 75 μ L, dark blue - 100 μ L, light blue - 200 μ L; C18H 250 x 4 mm; 5 μ m; 0.8 mL/min; 3 % methanol; 25°C; 50 mg/mL

MATERIALS AND METHOD

The AZURA HPLC system consisted of AZURA P 6.1L 10 ml HPG sst pump, AZURA AS 6.1L autosampler, AZURA RID 2.1L detector, AZURA Assistant with two 6 port multi-position stainless steel valves for column switching and an AZURA CT 2.1 column thermostat. Final method was as follows: 0.8 mL/min, 25°C, 70 min at 3 % methanol, 10 min at 30 % methanol, 40 min at 3 % methanol.

CONCLUSION

An automated column switching assistant is the optimal device for fast and effective stationary and mobile phase screening. An existing method was optimized with focus on a later up-scaling for purification of CDs. The method will allow to purify CD10, CD11 and CD12 in high purity in batch purification process.

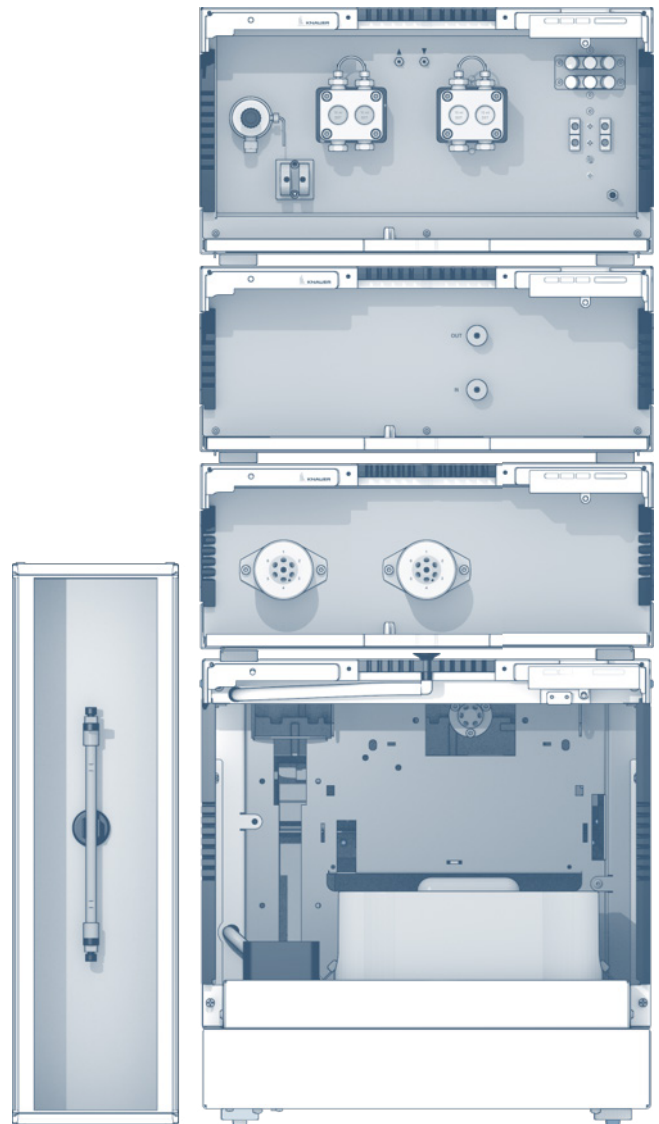

REFERENCES

- [4] E.M. Martin del Valle (2003), Cyclodextrins and their uses: a review, *Process Biochemistry*, Volume 39, Issue 9, Pages 1033-1046, ISSN 1359-5113
- [5] Sonnendecker, C. , Thürmann, S. , Przybylski, C. , Zitzmann, F. D., Heinke, N. , Krauke, Y. , Monks, K. , Robitzki, A. A., Belder, D. and Zimmermann, W. (2019), Large-Ring Cyclodextrins as Chiral Selectors for Enantiomeric Pharmaceuticals. *Angew. Chem. Int. Ed.*. doi:10.1002/anie.201900911

ADDITIONAL RESULTS

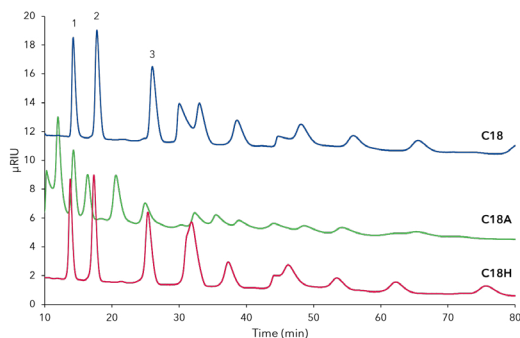

Fig.A1 Comparison separation of CD mixture (25 mg/mL) on three different stationary phases; blue - C18, green - C18A, red - C18H; 1 - CD10, 2 - CD11, 3 - CD12; all columns 150 x 4mm, 5 µm, 0.8 mL/min, 25°C, 50 µL inject.

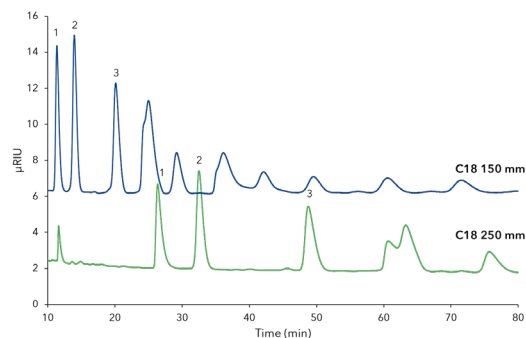

Fig.A2 Comparison separation of CDmix (25 mg/mL) on C18 columns with different lengths; CDmix (25 mg/mL), blue - 150 x 4 mm, green - 250 x 4 mm; 1 - CD10, 2 - CD11, 3-CD12, 5 µm, 0.8 mL/min, 25°C, 50 µL inject

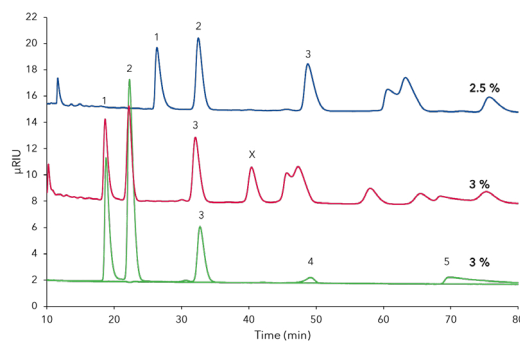

Fig.A3 Comparison separation of CDmix with 2.5 % and 3 % methanol on C18 column 250 x 4 mm. CDmix (25 mg/mL), blue - 2.5 % methanol, red - 3.0 %, green - standards at 3.0 % methanol; 1) CD10, 2) CD11, 3) CD12, 4) CD8, 5) CD 9; 5 µm; 0.8 mL/min; 25°C; 50 µL

ADDITIONAL MATERIALS AND METHODS

Tab.A1 Method parameters

Column temperature	25°C	Detection wavelength	RI
Injection volume	50 µL	Data rate	20 Hz
Injection mode	Partial loop	Time constant	0.05 s

Tab.A2 Pump parameters

Eluent A	3 % methanol		
Eluent B	30 % methanol		
Flow rate	0.8 mL/min		
Pump program	Time [min]	% A	% B
	0-70	100	0
	70-80	0	100
	80-120	100	0

Tab.A3 System configuration

Instrument	Description	Article No.
Pump	AZURA P 6.1L, HPG, 10mL, SST	APH35EA
Detector	AZURA RID 2.1L	ADD31
Assistant	Left: 6 MPV Middle: 6 MPV Right: free	
Thermostat	AZURA CT 2.1	A05852
Column	Eurospher II 100-5-C18 150x4mm	15WE181E2J
	Eurospher II 100-5-C18 250x4mm	25WE181E2J
	Eurospher II 100-5-C18H 150x4mm	15WE185E2J
	Eurospher II 100-5-C18H 250x4mm	25WE185E2J
Software	ClarityChrom 7.4.2	A1670

RELATED KNAUER APPLICATIONS

[VPH0068](#) - Cyclodextrin purification (Part 2): Method transfer and purification

Easy and fast isolation of rosmarinic acid from lemon balm with mass-directed purification

Jan Wendrich, Yannick Krauke, Lilit Avagyan, Kate Monks; applications@knauer.net
KNAUER Wissenschaftliche Geräte GmbH, Hegauer Weg 38, 14163 Berlin; www.knauer.net



SUMMARY

Rosmarinic acid is a natural product widely spread over different plant families. Preparative reversed-phase chromatography was used for the mass-directed purification of rosmarinic acid from a lemon balm extract. The AZURA® Prep HPLC system together with the 4000 MiD mass spectrometer was showed to be well suited for this application.

INTRODUCTION

The ubiquitous natural product rosmarinic acid shows antiviral, antimicrobial and anti-inflammatory characteristics. It is used in different kinds of medicinal products for example in ointments for sports injuries. Leaves of lemon balm contain a high concentration

of rosmarinic acid and are therefore an interesting source for the isolation of this compound. Here, we present an effective and time-saving method for the isolation of rosmarinic acid from a lemon balm extract based on the technique of mass-directed purification.



Easy and fast isolation of rosmarinic acid from lemon balm with mass-directed purification

RESULTS

A method for the isolation of rosmarinic acid from a lemon balm extract was developed on an analytical scale using an AZURA Analytical System and a Eurospher II C18 column (Fig 1). The UV spectra from the analysis showed the presence of many compounds with the structural motif of a phenyl acrylic acids. For a time-saving isolation of the target compound, the developed method was then transferred directly to

the AZURA Preparative System with the ability to fractionate via molecular mass. One fraction with a compound of the desired mass (m/z 359.2; $[M-H]^-$) was collected (Fig 2 & Fig 3). The following analysis of this fraction with the AZURA Analytical System showed that it was possible to isolate the target compound rosmarinic acid with the technique of mass-directed purification in a purity of >95% (Fig 4).

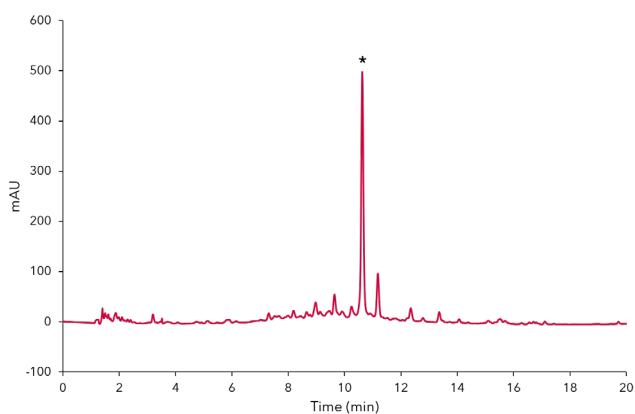

Fig. 1 Analytical chromatogram of the crude lemon balm extract at 280 nm; gradient separation 20 %-100 % acetonitrile, *rosmarinic acid peak

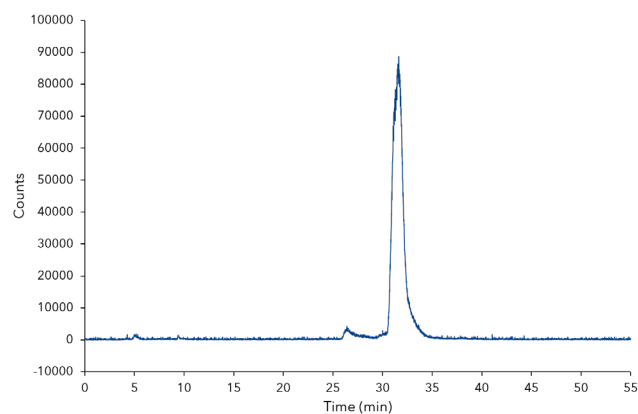

Fig. 2 SIM (single ion monitoring) chromatogram of a purification run for the target mass of m/z 359.2

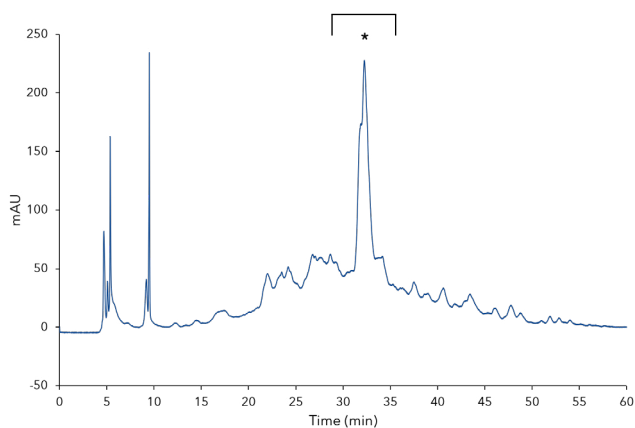

Fig. 3 UV-Chromatogram of a purification run for the crude lemon balm extract at 280 nm, *rosmarinic acid peak

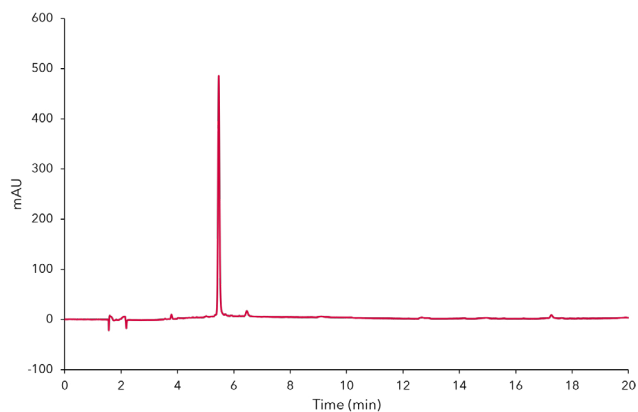

Fig. 4 Analytical chromatogram of the fraction containing rosmarinic acid at 280 nm, isocratic separation 50/50 water/acetonitrile

MATERIALS AND METHODS

AZURA Analytical HPLC System was used for the method development consisting of a low-pressure gradient AZURA P6.1L pump, an AZURA AS 6.1L auto-sampler, an AZURA DAD 2.1L diode array detector equipped with a 10 mm PressureProof flow cell and an Eurosphere II 100-5 C18 150 x 4.6 mm column.

The gradient method was run for 20 min at a flow rate of 1 mL/min starting with 80/20 % water/acetonitrile increasing to 100 % acetonitrile over 20 min. Both eluents contained 0.1 % formic acid as an additive. The wavelength of the detector was set to 280 nm at a data rate of 20 Hz. 10 μ L of the sample was injected.

AZURA Preparative HPLC System was used for the mass-directed purification of rosmarinic acid. The system consisted of an AZURA P 2.1L pump equipped with a 250 mL pump head and a three channel

low pressure gradient (LPG) ternary module, a manual injection valve (1/8", 6 port 2 kanal) equipped with a 5 mL sample loop, an AZURA DAD 6.1L diode array detector equipped with a 3 mm PressureProof flow cell, a 4000 MiD mass spectrometer with the MiDas sampling unit, a AZURA V 2.1S equipped with a 6 port multi position valve for fractionation and an Eurospher II 100-10 C18 250 x 30 mm column. The gradient method run for 67 min at a flow rate of 21.3 mL/min under the same conditions as the analytical method described above. The wavelength of the DAD was set to 280 nm at a data rate of 10 Hz, while the mass selective detector was set to SIM mode monitoring the relevant mass of m/z 359.2. The data trace of the mass selective detector was used for fractionation via the multi-position valve. 5 mL of the crude extract obtained under sonication from dried leave material with 30 % isopropanol was injected.

CONCLUSION

Rosmarinic acid was the main metabolite of the extracted lemon balm material. This target molecule was isolated in a short time with an AZURA Preparative HPLC system using the technique of mass-directed purification. By this, the number of fractions was reduced to one leading to a significant decrease of past analysis time.

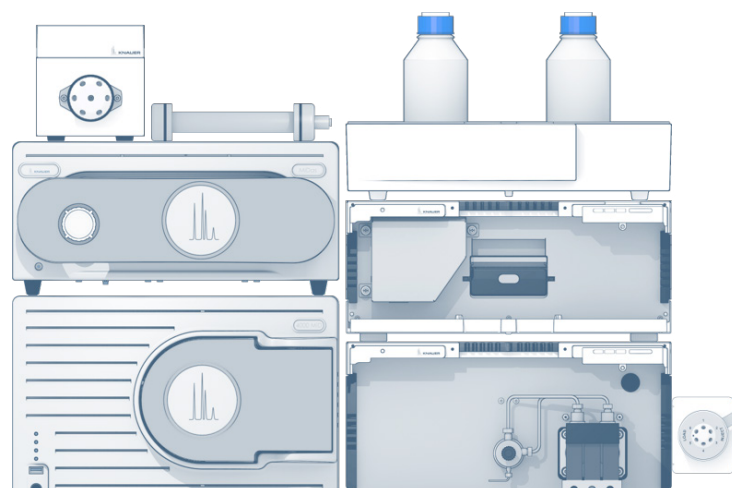

ADDITIONAL RESULTS

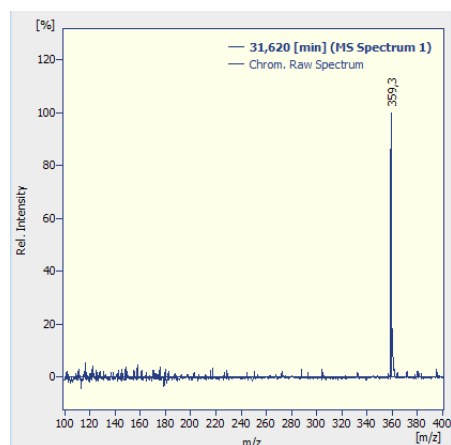

Fig. A1 Mass spectrum of rosmarinic acid ([M-H]-).

ADDITIONAL MATERIALS AND METHODS

Tab. A1 Method parameters (preparative)

Eluent A	Water + 0.1 % formic acid		
Eluent B	Acetonitrile + 0.1 % formic acid		
Gradient	Time [min]	% A	% B
	0	80	20
	67	0	100
Flow rate	21.3 mL/min	System pressure	100 bar
Run temperature	RT	Run time	67 min
Injection volume	5 mL	Injection mode	Full loop
Detection wavelength	280 nm	Data rate	10 Hz
		Time constant	0.1 s

Tab. A3 System configuration & data (analytical system)

Instrument	Description	Article No.
Pump	AZURA P 6.1L	APH34GA
Autosampler	AZURA AS 6.1L	AAA00AA
Detector	AZURA DAD 2.1L	ADC01
Flow cell	PressureProof Flow cell 10 mm 10 µl	AMC38
Column	Eurospher II 100-5 C18 with precolumn, Vertex Plus Column 150 x 4.6 mm	15VE181E2J
Software	ClarityChrom	A1670
	ClarityChrom 7.4.2 - PDA extension	A1676

Tab. A2 Method parameters (mass spectrometer analysis)

Scan mode	Interleave (Scan/SIM)
Mass range	100-400 m/z
Scan rate	1 Hz
Step	0.2
SIM	359.2 m/z
Ion mode	Negative
Gas flow	2.5 L/min

Tab. A4 System configuration & data (preparative system)

Instrument	Description	Article No.
Pump	AZURA P 2.1L 250 mL	APE20LA
	AZURA LPG module for Pump P 2.1L	AZZ00AB
Injection	AZURA V 2.1S Valve 6 Port 2 Position	A1359
Sample loop	5 mL Sample loop	A0586-2
Detector	AZURA DAD 6.1L	ADC11
Flow cell	PressureProof flow cell 3 mm 2 µL	AMB18
Mass spectrometer	4000 MiD with MiDas	A66900
Fractionation	AZURA V 2.1S Valve 6 Port Multiposition	AWA10BC
Software	ClarityChrom	A1670
	ClarityChrom PDA Extension	A1676
	ClarityChrom MS Extension	A1679
	ClarityChrom FRC control module	A1682
Column	VertexPlus AX Column 250x30 mm Eurospher II 100-10 C18	25QE181E2N

Cyclodextrin purification (Part 2): Method transfer and purification

Yannick Krauke*, Sebastian Thürmann*, Christian Sonnendecker**,
Kate Monks* – applications@knauer.net

*KNAUER Wissenschaftliche Geräte GmbH, Hegauer Weg 38,
14163 Berlin – www.knauer.net

** Fakultät für Lebenswissenschaften / Institut für Biochemie AG
Mikrobiologie und Bioverfahrenstechnik,
Johannisallee 21-23, 04103 Leipzig



SUMMARY

Cyclodextrins (CD) are macrocyclic compounds composed of five or more glycopyranosides. These ring structures can function as micro-capsules. Hence, CDs often find interesting applications in drug delivery. In this application, five CDs were purified in high purity from a CD mixture derived from a biocatalytic synthesis.

INTRODUCTION

Cyclodextrins (CD) are oligosaccharides of glucopyranose that are bound in a cyclic form of five to up to 12 units. The ring structure can function as a micro-capsule for other molecules. Due to their unique chemical structure they find different applications i. e. as drug carriers, in cosmetics, or in food industry. High amounts of CDs with more than 10 sub-

units (CD>10) are of special interest since larger molecules can be inserted into their rings [1]. Therefore, new approaches for synthesis and purification especially of CD >10 are conducted increasingly. A purification method previously developed in analytical scale was here transferred to preparative scale (KNAUER application note [VPH0066](#)).

Cyclodextrin purification (Part 2): Method transfer and purification

RESULTS

The method parameters for cyclodextrin purification were developed and optimized prior in analytical scale (see application note [VPH0066](#)). The mass and volume overload studies revealed that 100 μL injections of 100 mg/mL cyclodextrin mixture would still allow highly pure purification of at least four cyclodextrin ([VPH0066](#)). A linear scale-up from analytical to preparative scale was performed. The column length and particle size remained the same (250 mm; 5 μm), the inner diameter was increased from 4 mm to 20 mm. The [KNAUER scale up converter](#) was used

for fast determination of preparative method parameters, the flow rate was increased to 20 mL/min and sample injection volume to 2 mL. The chromatogram of the preparative CD mix run showed baseline separation of five CD peaks ([Fig. 1](#)). These five peaks were collected using the threshold function of PurityChrom software exceeding a certain μRIU value. Chromatograms from samples of each fraction were compared to chromatogram of the whole CD mixture. The overlay clearly showed that all fractions were 100 % pure and no contamination from neighbor peaks ([Fig. 2](#)).

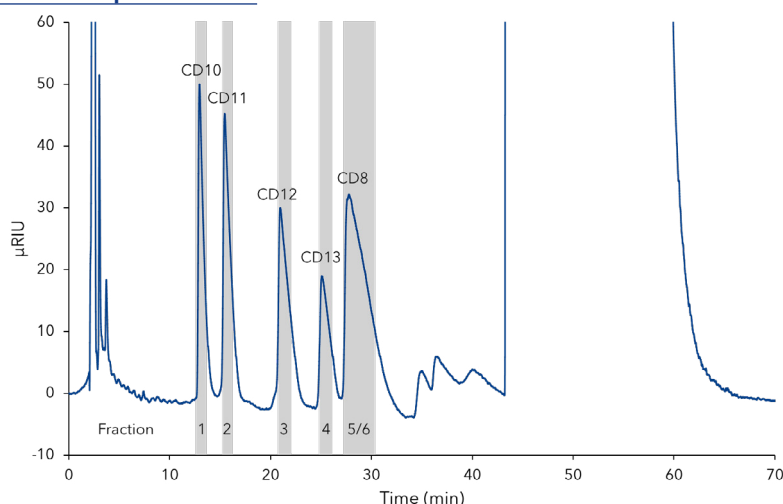

Fig. 1 Separation of CDmix on C18H 250x20mm column, 2 mL injection, 100 mg/mL CD mix; indication of collected fractions

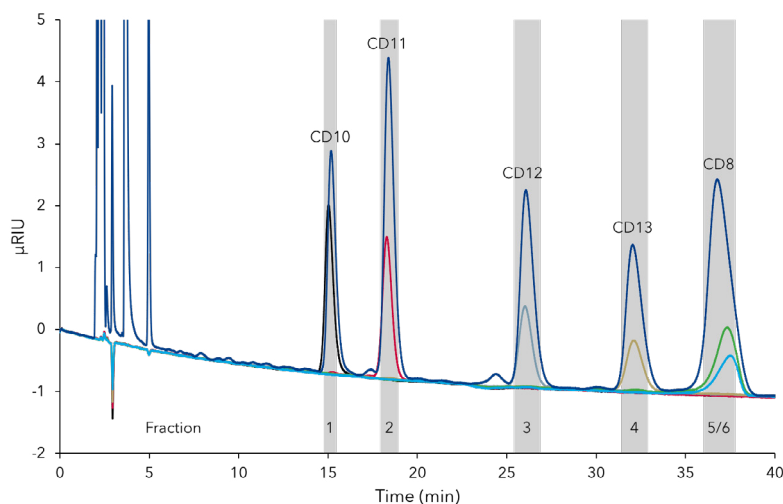

Fig. 2 Overlay analytical chromatograms of CDmix and the fractions collected from purification step ([Fig. 1](#)) black Frc1; red Frc2, light blue Frc3, yellow Frc4, green and blue Frc5/Frc6

MATERIALS AND METHOD

The AZURA Preparative HPLC system consisted of AZURA P2.1L 100 mL sst pump with ternary LPG module, AZURA RID 2.1L high flow detector and AZURA assistant module with 12 port multi position 1/8" sst valve (fractionation), 6 port 2 position 1/16" sst injection valve and P4.1S 50 ml sst feed pump. Final purification method was as follow: 20 mL/min, RT, 40 min 3% methanol, 14 min 30% methanol, 20 min 3 % methanol. Peaks were fractionated with threshold function over μ RIU signal. Fraction analysis was performed with AZURA analytical RI system as described in application note [VPH0066](#).

CONCLUSION

A previously in analytical scale developed purification method for cyclodextrine was transferred to semi-preparative scale by linear scale-up. Five cyclodextrines were purified in nearly 100 % purity and the results showed that higher loading would be possible without to much loss in purity. The preparative refractive index detector AZURA RID 2.1L HighFlow allowed detection at flow rates of 20 mL/min without using a flow splitter thus facilitating the purification process. All together a new approach for cyclodxtrine purification was developed.

REFERENCES

- [6] E.M.Martin Del Valle, Cyclodextrins and their uses: a review, *Process Biochemistry*, Volume 39, Issue 9, 2004, Pages 1033-1046,ISSN 1359-5113
- [7] Sonnendecker, C. , Thürmann, S. , Przybylski, C. , Zitzmann, F. D., Heinke, N. , Krauke, Y. , Monks, K. , Robitzki, A. A., Belder, D. and Zimmermann, W. (2019), Large-Ring Cyclodextrins as Chiral Selectors for Enantiomeric Pharmaceuticals. *Angew. Chem. Int. Ed.*. doi:10.1002/anie.201900911

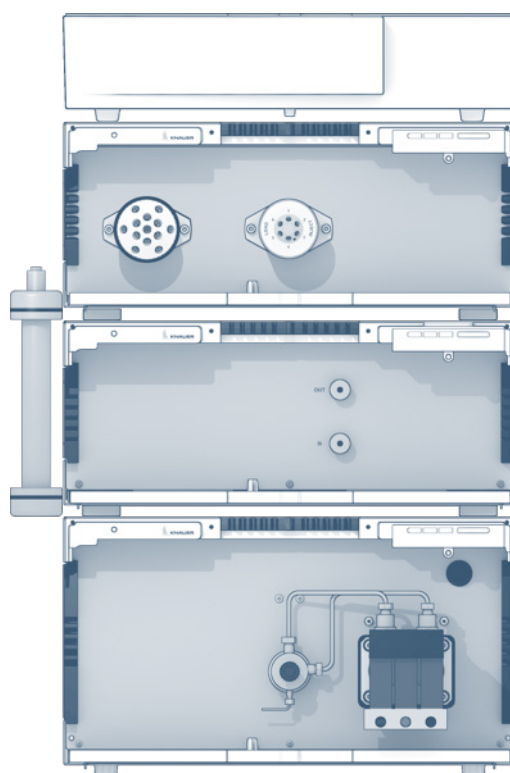

ADDITIONAL RESULTS

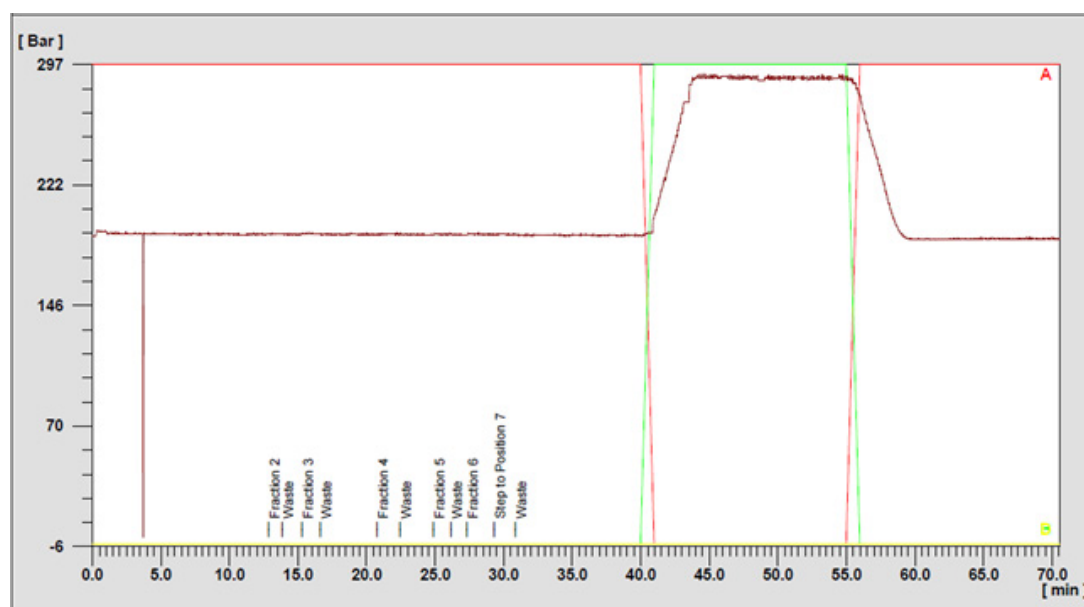

Fig.A1 Pressure fractionation, prep run

ADDITIONAL MATERIALS AND METHODS

Tab.A1 Method parameters

Column temperature	RT	Detection wavelength	RI
Injection volume	2 mL	Data rate	20 Hz
Injection mode	Full loop	Time constant	0.05 s

Tab.A2 Pump parameters

Eluent A	3 % methanol		
Eluent B	30 % methanol		
Flow rate	20 mL/min		
Pump program	Time [min]	% A	% B
	0-40	100	0
	40-55	0	100
	55-75	100	0

Tab.A3 System configuration

Instrument	Description	Article No.
Pump	AZURA P2.1L, 100 mL, SST	APE20KA
	AZURA LPG ternary module for Pump P 2.1L	AZZ00AB
Detector	AZURA RID 2.1L High flow	ADD38
Assistant	Left: 12Mpos,1/8",sst Middle:6Port2Pos,1/16",sst Right:P4.1S, 50ml,sst	AYFAEABR
Column	Eurospher II 100-5 C18H 250x20mm	25PE185E2J
	Eurospher II 100-5 C18H 30x20mm	03PE185E2J
	Eurospher II 100-5 C18H 250x4mm	25WE185E2J
Software	PurityChrom basic	A2650
	KNAUER Scale up converter	A1696

RELATED KNAUER APPLICATIONS

[VPH0066](#) - Cyclodextrin purification (Part 1): Method screening and overload studies

Simplified scale up for sugars with the AZURA® RID 2.1L extended dynamic range option



Juliane Böttcher, Kate Monks; applications@knauer.net
KNAUER Wissenschaftliche Geräte GmbH, Hegauer Weg 38, 14163 Berlin; www.knauer.net

SUMMARY

The extended dynamic range (EDR) option for the AZURA® RID 2.1L refractive index detector was investigated with a simple sample consisting of two common sugars. Calibration curves covering the range 700 μ RIU to 2300 μ RIU were generated with activated and deactivated EDR. A gain of about 65 % in dynamic range could be demonstrated over this range. Further benefits, such as simplified sample preparation, and improved fractionation possibilities are also discussed.

INTRODUCTION

The extended dynamic range (EDR) option of the AZURA RID 2.1L enables the linear dynamic range to be broadened in +100 % (-1000 μ RIU offset) or -100 % (+1000 μ RIU offset) [1]. This feature enhances the application of this detector for semi-preparative, preparative, and scale-up purposes. For instance, when carrying out overload studies, it is necessary to know how much sample and at which concentration

can be injected on an analytical column. Often these measurements are out of the detector's linear dynamic range. The EDR feature is very useful in this case because it enables the more exact calculation of the amount of sample that can be loaded on a column for purification without the need for additional sample preparation.

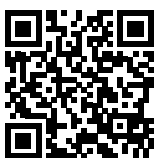

Simplified scale up for sugars with the AZURA® RID 2.1L extended dynamic range option

RESULTS

To investigate the influence of the EDR option a simple method was chosen. A solution with a concentration of 40 mg/mL glucose and saccharose was injected with different volumes (10 µL, 20 µL, 30 µL, 40 µL, 50 µL, 100 µL, 200 µL) and measured with and without activated EDR. **Fig 1** shows an overlay of an injection of 50 µL with and without extension. The blue trace is without extension, the red trace is detected using the

+100% option. When using the extension, a better resolution was gained as well as a higher and sharper signal was achieved. Now it was possible to measure up to 2.5 mRIU without difficulty. The advantage of the EDR option due to the linearity of calibration is visualized in **Fig 2**. It is shown that when using the extension, better values of linearity and correlation coefficient can be achieved over a wide range.

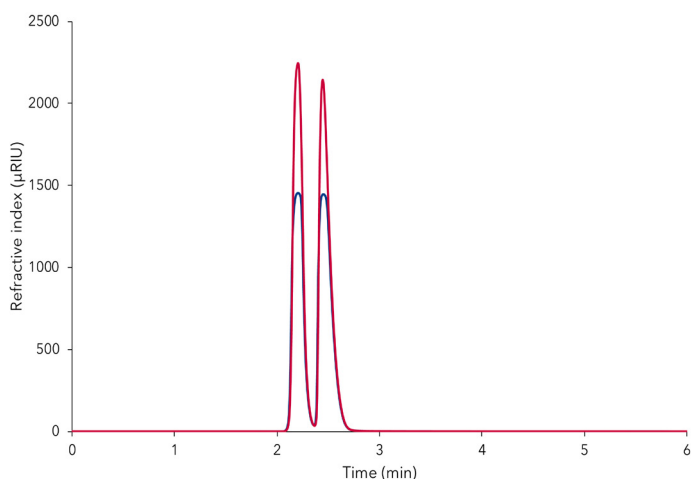

Fig. 1 Overlay of an injection with 50 µL, blue = without extension, red = with extension (+100%)

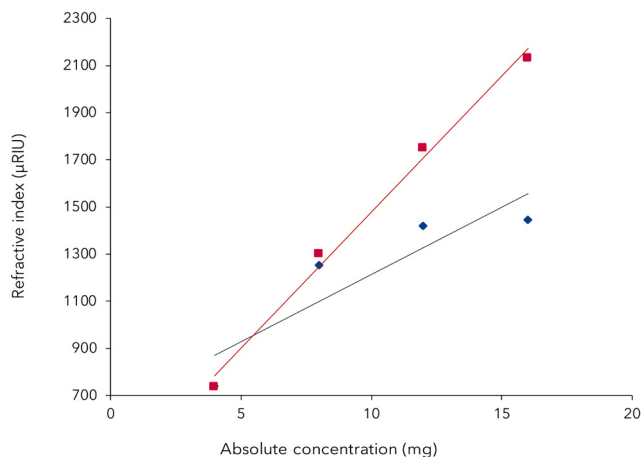

Fig. 2 Linearity of glucose calibration with (red, R=0.9924) and without (blue, R=0.8087) EDR option

MATERIALS AND METHOD

An AZURA® Analytical HPLC Plus system was used for this application. The system consisted of an isocratic AZURA P 6.1L pump, an AZURA AS 6.1L autosampler, an AZURA CT 2.1 column thermostat and an AZURA RID 2.1L refractive index detector. The used column was filled with Eurospher II 100 5 C18A silica. The isocratic method ran at a flow rate of 1.0 mL/min with a 100 % aqueous eluent for 6 minutes. The column thermostat was set to 25 °C and the data rate of the detector to 20 Hz. Different volumes (10 µL, 20 µL, 30 µL, 40 µL, 50 µL, 100 µL, 200 µL) of a solution containing 40 mg/mL of glucose and saccharose were injected.

CONCLUSION

The EDR feature was shown to prevent the need to dilute samples, which saves time and money and diminishes additional errors during sample preparation. Furthermore, due to an improved peak shape at high sample concentrations, software fractionation algorithms can work more efficiently. Therefore this feature facilitates a more efficient purification. Here, the EDR was used in positive mode (+100 %). For applications with inverted peaks, similar applicative benefits could be achieved by activating the negative mode EDR (-100 %). This was not carried out in this study.

REFERENCES

[1] http://www.knauer.net/fileadmin/user_upload/produkte/files/Dokumente/detectors/azura/PITTCON_REFRACTIVE_INDEX_DETECTOR_KIT_2017.pdf

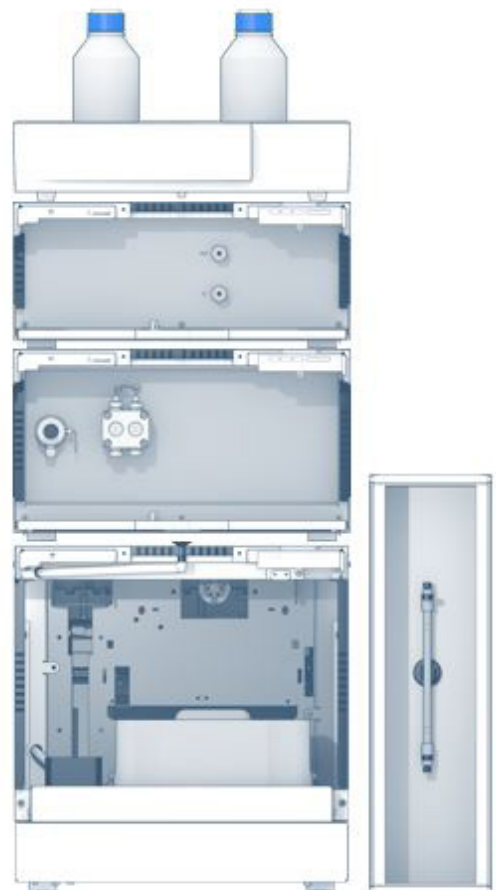

ADDITIONAL MATERIALS AND METHODS

Tab. A1 Method parameters

Eluent A	H ₂ O _{dd}		
Gradient	Isocratic, 100 % A		
Flow rate	1 mL/min	Run time	6 min
Column temperature	25 °C	Injection mode	Partial loop/Full loop
Injection volume	10 µL, 20 µL, 30 µL, 40 µL, 50 µL, 100 µL, 200 µL	Data rate	20 Hz
		Time constant	0.05 sec

Tab. A2 System configuration

Instrument	Description	Article No.
Pump	AZURA P 6.1L, isocratic, 10 mL, SS	APH30EA
Autosampler	AZURA AS 6.1L	AAA00AA
Detector	AZURA RID 2.1L	ADD31
Thermostat	AZURA CT 2.1	A05852
Eluent tray	AZURA E 2.1L	AZC00
Column	Vertex Plus Column, 250x4 mm, Eurospher II 100-5 C18A with precolumn	25WE184E2J
Software	ClarityChrom 6.1.0	A1670-9

RELATED KNAUER APPLICATIONS

[VFD0160](#) - Determination of sugars and natural sugar substitutes in different matrices

[VFD0161](#) - Determination of sugars in honey using HILIC separation and RI detection

[VFD0155](#) - Semi preparative xylitol purification with dedicated sugar purification system

[VFD0150](#) - Alternative xylitol extraction via hplc purification from fermented biomass

Column choice based on Tanaka characterization - not all C18 columns are the same

Juliane Böttcher, Mareike Margraf, Kate Monks; applications@knauer.net
KNAUER Wissenschaftliche Geräte GmbH, Hegauer Weg 38, 14163 Berlin; www.knauer.net

SUMMARY

Reversed Phase (RP) is with more than 90 % market share by far the most commonly used HPLC mode. The best known and most used surface modification is C18. Although the USP column code (L1) is the same for all C18 phases, there are a lot of differences which must be considered when choosing the right column. C18 always is a good choice for an initial try but one must bear in mind that not all C18 phases have the same separation characteristics. To differentiate between such phases Tanaka plots are extremely useful.

INTRODUCTION

The Tanaka test is an accepted standard method for the evaluation of performance and selectivity of a reversed phase HPLC column [1]. The Tanaka protocol is based on six variables (hydrophobic retention factor, hydrophobic selectivity, shape selectivity, hydrogen bonding capacity, total ion exchange capacity, acidic ion exchange capacity) reflecting different chromatographic properties. Here we focus on the hydrophobic retention, hydrophobic selectivity and shape selectivity of the following KNAUER C18 phases: Eurospher II C18 (ES II C18), Eurospher II C18 A (ES II C18 A), Eurospher II C18 H (ES II C18 H), Eurospher II C18 P (ES II C18 P), Eurospher I C18 (ES I C18), and

Eurosil Bioselect C18 (EB C18). The hydrogen bonding capacity and ion exchange capacities are not considered here because they are nearly similar for the examined phases. The hydrophobic retention factor (HR) reflects the surface area and surface coverage (ligand density). Hydrophobic selectivity (HS) is a measure of the surface coverage of the phase as the selectivity between alkylbenzenes differentiated by one methylene group is dependent on the ligand density. Shape selectivity (SS) is a dimension which is influenced by the spacing of the ligands and probably also the shape/functionality of the silylating reagent [1].

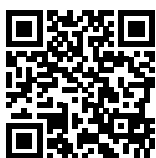

Column choice based on Tanaka characterization - not all C18 columns are the same

RESULTS

A hexagonal net diagram was used to display the measured Tanaka parameters as it enables good visual comparison of phases. For this type of diagram measured values are multiplied by certain factors. The measured values without multipliers are shown in **Tab A1** in the additional results section. **Fig 1 to 3** show the Tanaka plots for the tested phases. The values for the ion exchange capacity and hydrogen bonding capacity are quite similar for all and were

therefore not considered. The biggest difference between the tested phases could be seen when comparing the hydrophobic retention factor (HR) - the higher this value the less polar the modification. Sorting the phases with ascending hydrophobic retention leads to the following order: EB C18 > ES II C18 A > ES I C18 > ES II C18 > ES II C18 H > ES II C18 P. The value for shape selectivity of the Eurospher I phase is slightly deviating. This may be due to an incomplete endcapping.

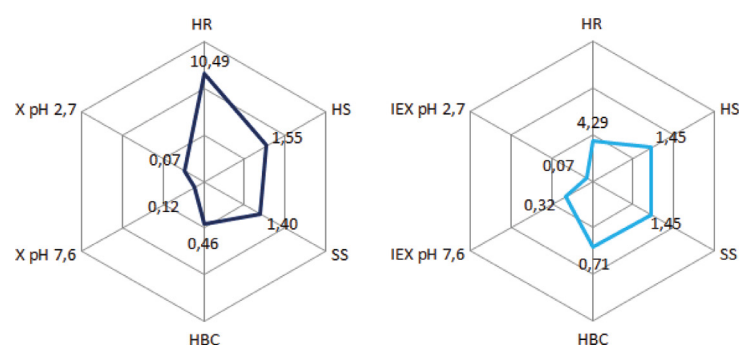

Fig. 1 Tanaka Plots of Eurospher II 100-5 C18 (left) and Eurospher 100-5 C18 A (right) T

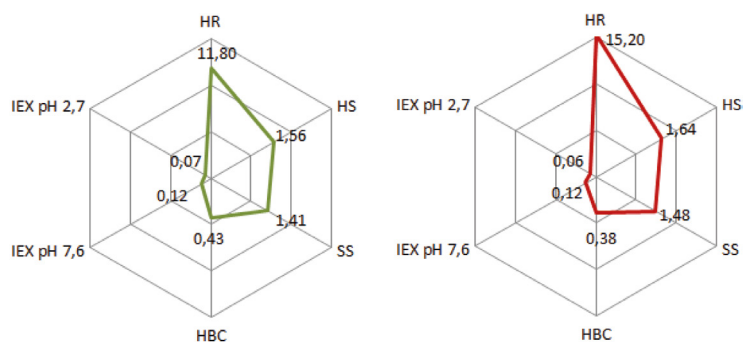

Fig. 2 Tanaka plots of Eurospher II 100-5 C18 H (left) and Eurospher II 100-5 C18 P (right)

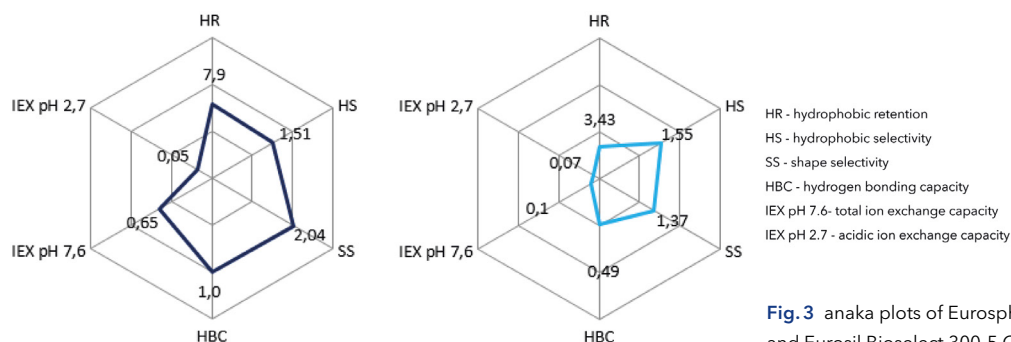

Fig. 3 Tanaka plots of Eurospher I 100-5 C18 (left) and Eurosil Bioselect 300-5 C18 (right)

HR - hydrophobic retention
 HS - hydrophobic selectivity
 SS - shape selectivity
 HBC - hydrogen bonding capacity
 IEX pH 7.6- total ion exchange capacity
 IEX pH 2.7 - acidic ion exchange capacity

MATERIALS AND METHODS

For the determination of the Tanaka parameters the KNAUER AZURA® Educational System was used. The method ran isocratically with a mobile phase composition of methanol:water 80:20 (v/v). The column thermostat AZURA® CT 2.1 was set to 30 °C and the UV detector was set to 254 nm. All used columns had a dimension of 150 x 4 mm ID and were filled with the following silica: Eurospher II 100-5 C18, Eurospher II 100-5 C18 A, Eurospher II 100-5 C18 H, Eurospher II 100 5 C18 P, Eurospher I 100-5 C18 and Eurosil Bioselect 300-5 C18. This method was used only for determination of HR, HS and SS. Detailed method parameters for HBC and IEX are attached in the additional materials and methods section (**Tab A3 & A4**).

CONCLUSION

The results obtained from the Tanaka test comparison can be used to assist in the choice of the most appropriate column for a given separation task. It is also important to know as much as possible about the chemical properties of the analyte. An analyte that is soluble only in a solvent with a high organic amount will have slightly or no retention on a C18 A phase. However, the C18 A phase can be operated with 100 % aqueous eluent without destroying the stationary phase. Inversely, a very polar analyte might have less retention on the C18 P or C18 H modification. However, due to their high carbon content they provide a high pH stability in an extended pH range. Furthermore, if the molecular weight of the analyte is above 2000 Da, a pore size of with 100 Å may be insufficient, making the so Eurosil Bioselect with a pore size of 300 Å the better choice. The KNAUER column portfolio offers classical and special C18 phases, making it easy to find the most appropriate column for a given application task.

REFERENCES

[1] <http://www.chromatographyonline.com/column-selection-reversed-phase-hplc>

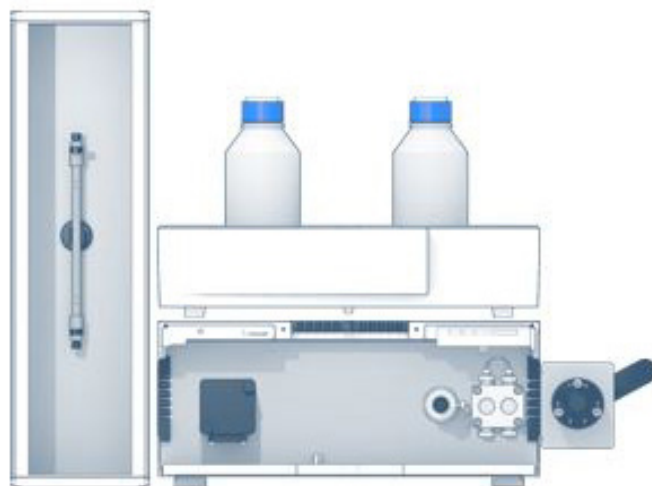

ADDITIONAL RESULTS

Tab. A1 Measured Tanaka values without multipliers

Column	HR	HS	SS	HBC	IEC pH 7.6	IEC pH 2.7
Eurospher II 100-5 C18	10.94	1.55	1.40	0.46	0.12	0.07
Eurospher II 100-5 C18 P	15.20	1.64	1.48	0.38	0.12	0.06
Eurospher II 100-5 C18 H	11.80	1.56	1.41	0.43	0.12	0.07
Eurospher II 100-5 C18 A	4.29	1.45	1.45	0.71	0.32	0.07
Eurospher I 100-5 C18	7.90	1.51	2.04	1.00	0.65	0.05
Eurosil Bioselect 300-5 C18	3.43	1.55	1.37	0.49	0.10	0.07

ADDITIONAL MATERIALS AND METHODS

Tab. A2 Method parameters (HR, HS, SS)

Eluent	Methanol: Water 80:20 (v/v)		
Gradient	isocratic		
Flow rate	1 mL/min	Run time	20 min
Column temperature	30 °C	Injection mode	Full loop
Injection volume	10 µL	Data rate	20 Hz
Detection	254 nm	Time constant	0.05 s

Tab. A3 Method parameters (HBC)

Eluent	Methanol: Water 30:70 (v/v)		
Gradient	isocratic		
Flow rate	1 mL/min	Run time	20 min
Column temperature	30 °C	Injection mode	Full loop
Injection volume	10 µL	Data rate	20 Hz
Detection	254 nm	Time constant	0.05 s

Tab. A4 Method parameters (IEX)

Eluent	Methanol: 0.02 M phosphate buffer pH 7.6 30:70 (v/v) Methanol: 0.02 M phosphate buffer pH 2.7 30:70 (v/v)		
Gradient	isocratic		
Flow rate	1 mL/min	Run time	20 min
Column temperature	30 °C	Injection mode	Full loop
Injection volume	10 µL	Data rate	20 Hz
Detection	254 nm	Time constant	0.05 s

Tab. A5 System configuration & data

Instrument	Description	Article No.
System	AZURA® Educational System (pump, detector, manual injection valve, ClarityChrom 7.2)	671101100
Column	Eurospher II 100-5 C18 Eurospher II 100-5 C18 A Eurospher II 100-5 C18 H Eurospher II 100-5 C18 P Eurospher I 100-5 C18 Eurosil Bioselect 300-5 C18 All: Vertex Plus Column 150 x 4 mm ID	15DE181E2J 15DE184E2J 15DE185E2J 15DE182E2J 15DE181ESJ 15DK181EBJ
Thermostat	AZURA® CT 2.1	A05852

Quantification of caffeine with the AZURA® Educational system and Mobile Control Software

Juliane Böttcher, Mareike Margraf, Kate Monks; applications@knauer.net
KNAUER Wissenschaftliche Geräte GmbH, Hegauer Weg 38, 14163 Berlin; www.knauer.net



SUMMARY

The AZURA® Educational system allows an easy and fast implementation of liquid chromatography (HPLC, high pressure liquid chromatography) and promotes a deeper understanding of this separation method. A simple example is given describing the determination of a sample containing caffeine and paracetamol.

INTRODUCTION

Caffeine and paracetamol are widely-used pharmaceutical components. Both substances are present as ingredients in many analgesics. Hence, they are often determined simultaneously in routine analysis. Theophylline, a substance chemically closely related to caffeine, is used to serve as an internal standard. [1] To analyze the components, the KNAUER HPLC Educational system is used providing isocratic elution

HPLC in combination with UV detection. The samples are injected via a manual injection valve. Based on the KNAUER AZURA Compact series, this system layout represents an easy and convenient solution for the current application. The determination of a sample containing caffeine and paracetamol is a typical example from applied research for the implementation of the KNAUER HPLC Educational system.

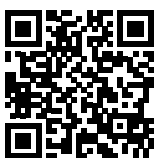

Quantification of caffeine with the AZURA® Educational system and Mobile Control Software

RESULTS

At first, stock solutions are prepared from caffeine, paracetamol and theophylline. The initial weight of the substances should be about 100 mg. However, it is important to note the exact sample weight to obtain accurate results for the quantitative analysis. All standards were dissolved and sonicated to yield stock solutions of approximately 10 mg/mL. To identify the individual substances directly by HPLC, the substances are diluted with water (Tab A1, Additional Materials and Methods). Secondly, a single calibration solution is prepared from the caffeine and paracetamol stock solution. For this purpose, 50 μ L of the caffeine stock solution and 50 μ L of the paracetamol stock solution are combined and diluted with water to a final volume of 5 mL. For the current application, five dilution levels (Tab A2, Additional Materials and Methods) have been prepared. Furthermore, 100 μ L of the theophylline stock solution are diluted

with water to a final volume of 1 mL. Subsequently, a volume of 20 μ L of this solution is added to standard 1 - 5. Fig 1 shows the chromatogram of the calibration standard at level 4 (60 μ g/mL). The peaks are baseline separated in less than 5 minutes. Fig 2 shows the measurement of an analgesic sample. Therefore, analgesic tablets containing paracetamol and caffeine were chosen. The internal standard theophylline was added according to the preparation of calibration solutions. A concentration of 53 mg caffeine was calculated for the sample. This amount refers to the weight of one tablet. Relating to the package insert, the analgesic should contain 50 mg caffeine per tablet. The deviation of the measured and proclaimed value might result from differing calibrations and/or measurement errors. For the detailed preparation of standards, sample and calibration please see application VSP0018.

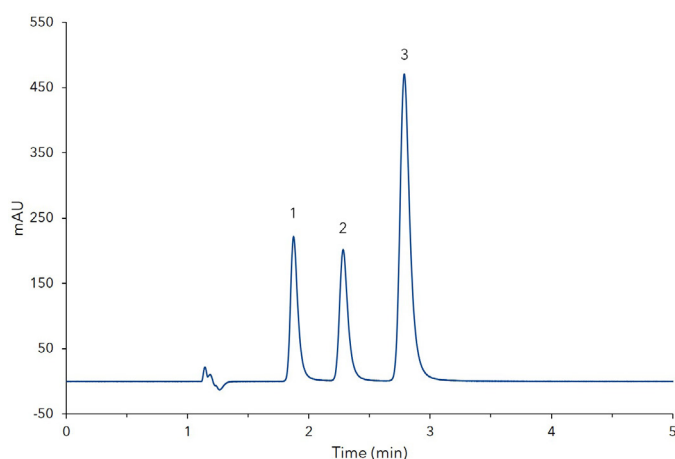

Fig. 1 Chromatogram of standard solution 4, 1) paracetamol, 2) theophylline (IS), 3) caffeine

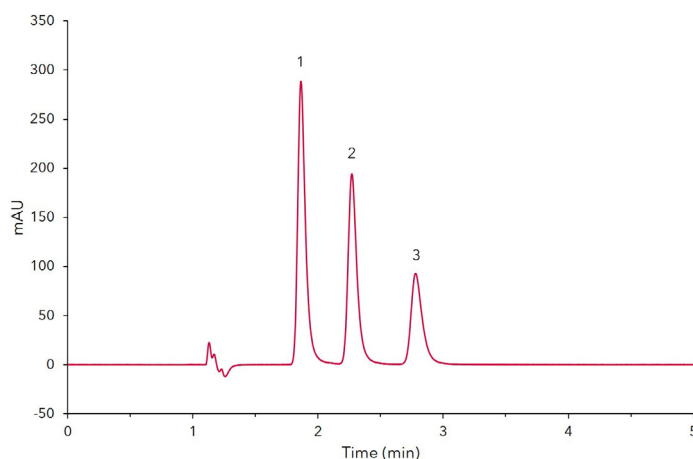

Fig. 2 Chromatogram of analgesic sample, 1) paracetamol, 2) theophylline (IS), 3) caffeine

MATERIALS AND METHODS

For the determination of caffeine and paracetamol the AZURA Educational system was used, which combines a P 4.1S pump, an UVD 2.1S and a manual injection valve in just one AZURA assistant. The flow rate was set to 0.8 ml/min at ambient temperature. The wavelength was set to 273 nm with a data rate of 20 Hz and a time constant of 0.05 s. 10 μ L of the standards and samples were injected. The isocratic method ran for 5 minutes with a mixture of methanol and water 40:60 (v/v). The column in a dimension 125 x 4 mm ID with precolumn was filled with Eurospher II 100-5 C18 silica. For the data acquisition the Mobile Control Chrom software was used.

CONCLUSION

The KNAUER HPLC Educational System provides both, a qualitative and quantitative analysis of caffeine from different chemical probes. The system is compact, very simple to operate and can be ideally used for practical training courses. The Mobile Control Chrom is an intuitive and cost-effective software solution for controlling and monitoring your AZURA devices and systems. In addition, you can acquire data from AZURA detectors allowing simple measurements.

REFERENCES

[1] Entry: internal standard. In: IUPAC Compendium of Chemical Terminology (the "Gold Book").
doi:10.1351/goldbook.i03108.

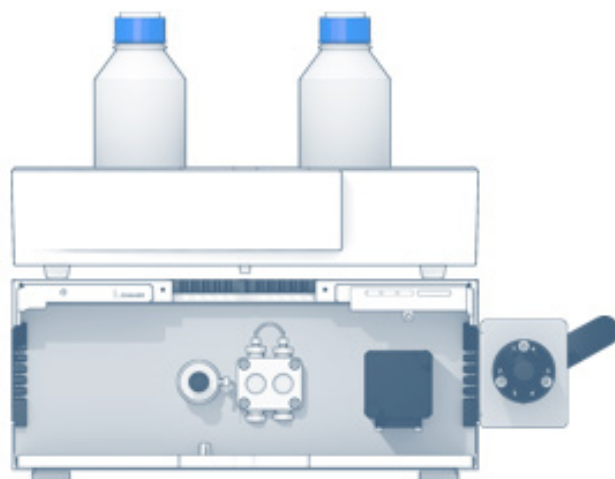

ADDITIONAL RESULTS

Tab. A1 Initial weight and dilution of stock solutions

Substance	Initial weight (mg)	Final conc. stock solution (mg/mL)	Final conc. diluted solution (µg/mL)
Caffeine	100.0	10.0	100.0
Theophylline	99.3	9.9	99.3
Paracetamol	98.7	9.9	98.7

Tab. A2 Caffeine standards 1 to 5

Caffeine standard	Projected caffeine conc. (V = 1 mL) (µg/mL)	Actual caffeine conc. (V = 1.02 mL) (µg/mL)
1	5	4.9
2	20	19.6
3	40	39.2
4	60	58.7
5	80	78.4

ADDITIONAL MATERIALS AND METHODS

Tab. A3 Method parameters

Eluent	Methanol:Water 40:60 (v/v)		
Gradient	isocratic		
Flow rate	0.8 mL/min	System pressure	approx. 115 bar
Column temperature	RT	Run time	5 min
Injection volume	10 µL	Injection mode	Full loop
Detection wavelength	273 nm	Data rate	20 Hz
		Time constant	0.05 s

Tab. A4 System configuration & data

Instrument	Description	Article No.
System	AZURA® Educational system	671101100
Column	Eurospher II 100-5 C18, Vertex Plus 125 x 4 mm ID with precolumn	12WE181E2J
Software	Mobile Control Chrom	A9608



[AZURA® Educational system](#)

RELATED KNAUER APPLICATIONS

[VSP0017](#) - Quantification of caffeine with the AZURA® Educational system and ClarityChrom software

[VSP0018](#) - Preparation of calibration and samples for the quantification of caffeine with the AZURA® Educational system

[VSP0019](#) - HPLC Basics - principles and parameters

Quantification of caffeine with the AZURA® Educational system and ClarityChrom software

Juliane Böttcher, Mareike Margraf, Kate Monks; applications@knauer.net
KNAUER Wissenschaftliche Geräte GmbH, Hegauer Weg 38, 14163 Berlin; www.knauer.net



SUMMARY

The AZURA® HPLC Educational System allows an easy and fast introduction to liquid chromatography (HPLC, high pressure liquid chromatography) and promotes a deeper understanding of this separation method. A simple example is given describing the determination of a sample containing caffeine, paracetamol and theophylline.

INTRODUCTION

Caffeine and paracetamol are widely-used pharmaceutical components. Both substances are present as ingredients in many analgesics. Hence, they are often determined simultaneously in routine analysis such as quality control. Theophylline, a substance chemically closely related to caffeine, is used to serve as an internal standard. [1] To analyze these three components, the AZURA Educational System was used providing

isocratic elution HPLC in combination with UV detection. The samples were injected via a manual injection valve. Based on the KNAUER AZURA Compact series, this system layout represents an easy and convenient solution for the current application. ClarityChrom is an easy-to-use Chromatography Data System for workstations. The Educational System license is exclusively bundled with the AZURA Educational System.



Quantification of caffeine with the AZURA® Educational system and ClarityChrom software

RESULTS

At first, stock solutions are prepared from caffeine, paracetamol and theophylline. The initial weight of the substances should be about 100 mg. However, it is important to note the exact sample weight to obtain accurate results for the quantitative analysis. All standards were dissolved and sonicated to yield stock solutions of approximately 10 mg/mL. To identify the individual substances directly by HPLC, the substances are diluted with water (Table 1, Additional Materials and Methods). Secondly, a single calibration solution is prepared from the caffeine and paracetamol stock solution. For this purpose, 50 μ L of the caffeine stock solution and 50 μ L of the paracetamol stock solution are combined and diluted with water to a final volume of 5 ml. For the current application, five dilution levels (Tab. 2, Additional Materials and Methods) have been prepared. Furthermore, 100 μ L of the theophylline stock solution are diluted

with water to a final volume of 1 mL. Subsequently, a volume of 20 μ L of this solution is added to standard 1 - 5. Fig 1 shows the chromatogram of the calibration standard at level 4 (60 μ g/mL). The peaks are baseline separated in less than 5 minutes. Fig 2 shows the measurement of an analgesic sample. Therefore, analgesic tablets containing paracetamol and caffeine were chosen. The internal standard theophylline was added to the sample according to the preparation of calibration solutions. A concentration of 53 mg caffeine was calculated for the sample. This amount refers to the weight of one tablet. Relating to the package insert, the analgesic should contain 50 mg caffeine per tablet. The deviation of the measured and proclaimed value might result from differing calibrations and/or measurement errors. For the detailed preparation of standards, sample and calibration please see application VSP0018.

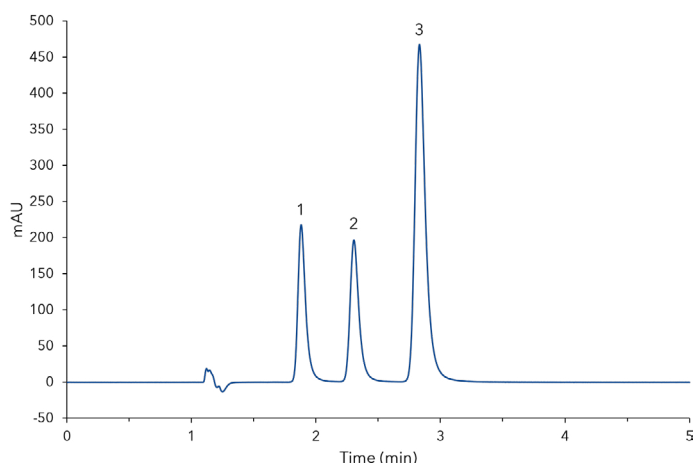

Fig. 1 Chromatogram of standard solution 4, 1) paracetamol, 2) theophylline (IS), 3) caffeine

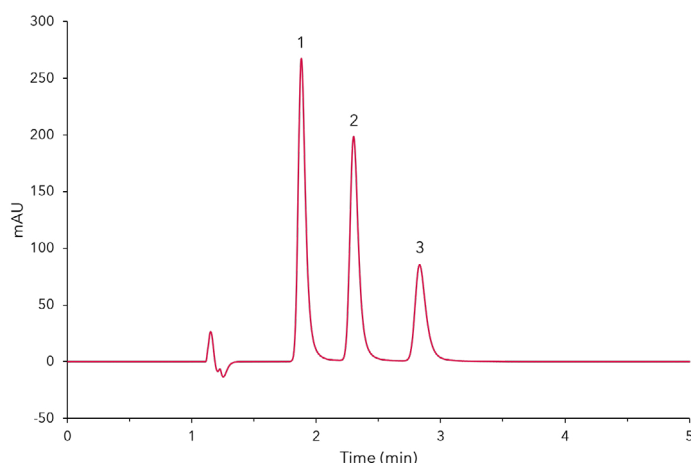

Fig. 2 Chromatogram of analgesic sample, 1) paracetamol, 2) theophylline (IS), 3) caffeine

MATERIALS AND METHODS

For the determination of caffeine and paracetamol the AZURA® Educational system was used, which combines a P 4.1S pump, an UVD 2.1S and a manual injection valve in just one AZURA assistant. The flow rate was set to 0.8 mL/min at ambient temperature. The wavelength was set to 273 nm with a data rate of 20 Hz and a time constant of 0.05 s. 10 µL of the standards and samples were injected. The isocratic method ran for 5 minutes with a mixture of methanol and water 40:60 (v/v). The column in a dimension 125 x 4 mm ID with precolumn was filled with Eurospher II 100-5 C18 silica. For the data acquisition the ClarityChrom software was used.

CONCLUSION

The AZURA HPLC Educational System provides both, a qualitative and quantitative analysis of caffeine from different chemical samples. The system is compact, very simple to operate and can be ideally used for practical training courses. The chromatography data system ClarityChrom offers an intuitive system configuration, control and the evaluation of data. More detailed information on hardware and software is available by videos and manuals which will be delivered with the system. The AZURA Educational system video tutorials are available on our website.

REFERENCES

[2] Entry: internal standard. In: IUPAC Compendium of Chemical Terminology (the "Gold Book"). doi:10.1351/goldbook.i03108.

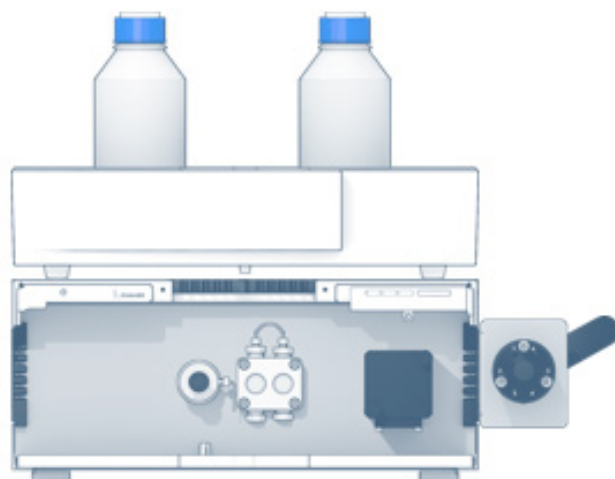

ADDITIONAL RESULTS

Tab. A1 Initial weight and dilution of stock solutions

Substance	Initial weight (mg)	Final conc. stock solution (mg/mL)	Final conc. diluted solution (µg/mL)
Caffeine	100.0	10.0	100.0
Theophylline	99.3	9.9	99.3
Paracetamol	98.7	9.9	98.7

Tab. A2 Caffeine standards 1 to 5

Caffeine standard	Projected caffeine conc.(V = 1 mL) (µg/mL)	Actual caffeine conc. (V = 1.02 mL) (µg/mL)
1	5	4.9
2	20	19.6
3	40	39.2
4	60	58.7
5	80	78.4

ADDITIONAL MATERIALS AND METHODS

Tab. A3 Method parameters

Eluent	Methanol:Water 40:60 (v/v)		
Gradient	isocratic		
Flow rate	0.8 mL/min	System pressure	approx. 115 bar
Column temperature	RT	Run time	5 min
Injection volume	10 µL	Injection mode	Full loop
Detection wavelength	273 nm	Data rate	20 Hz
		Time constant	0.05 s

Tab. A4 System configuration & data

Instrument	Description	Article No.
System	AZURA® Educational system	671101100
Column	Eurospher II 100-5 C18, Vertex Plus 125 x 4 mm ID with precolumn	12WE181E2J
Software	ClarityChrom® 7.2 - Educational License	A1672-11



[AZURA® Educational system](#)

RELATED KNAUER APPLICATIONS

[VSP0016](#) - Quantification of caffeine with the AZURA® Educational system and Mobile Control Software

[VSP0018](#) - Preparation of calibration and samples for the quantification of caffeine with the AZURA® Educational system

[VSP0019](#) - HPLC Basics - principles and parameters

Preparation of calibration and samples for the quantification of caffeine with the AZURA® Educational system

Juliane Böttcher, Mareike Margraf, Kate Monks; applications@knauer.net
KNAUER Wissenschaftliche Geräte GmbH, Hegauer Weg 38, 14163 Berlin; www.knauer.net



SUMMARY

The AZURA® Educational system allows an easy and fast implementation of liquid chromatography (HPLC, high pressure liquid chromatography) and promotes a deeper understanding of this separation method. A simple example is given describing the determination of a sample containing caffeine and paracetamol.

INTRODUCTION

The following descriptions are necessary to perform the measurements shown in KNAUER application notes VSP0016 and VSP0017. A detailed procedure for the preparation, dilution, and calculation of

standard solutions used for calibration and an analgesic sample will be executed here. This guidance is suitable for data acquisition with either Mobile Control or ClarityChrom.



Preparation of calibration and samples for the quantification of caffeine with the AZURA® Educational system

CALIBRATION PREPARATION

At first, individual stock solutions were prepared from caffeine, paracetamol, and theophylline. The initial weight of the substances should be about 100 mg (NOTE: for subsequent quantification it was important to record the exact initial weight). The substances were dissolved in 10 mL of methanol and sonicated to yield stock solutions of approx. 10 mg/mL. To identify the individual substances directly by HPLC, the substances were then diluted 1:100 with water. **Tab. 1** shows exemplary initial weights and dilutions of the stock solutions.

Secondly, a single calibration solution was prepared from the caffeine and paracetamol stock solutions. For this purpose, 50 µL of the caffeine stock solution and 50 µL of the paracetamol stock solution were combined and diluted with water to a final volume of 5 mL (1:100 dilution). Thus, each individual substance had a concentration of approx. 100 µg/mL. For HPLC

analysis, the dilution levels of the calibration solution should cover a range from 5-80 µg/mL. To ensure a correct measurement, at least four different dilution levels should be achieved. In this application, five dilution levels were prepared. The concentration of the calibration levels is shown in **Tab. 2**. The corresponding solutions were named standard 1 to 5. An additional calibration solution of the internal standard becomes necessary for quantitative HPLC analysis. For this purpose, 100 µL of the theophylline stock solution were diluted with water to a final volume of 1.00 mL (1:10 dilution, concentration approx. 1 mg/mL). Subsequently, a volume of 20 µL (final concentration approx. 20 µg/mL) of this solution was added to the standard solutions 1 to 5. Since, by the addition of the internal standard the final volume increased by 20 µL, it was important to calculate the concentration of caffeine in the final volume of 1.02 mL (**column 3, Tab. 2**).

Tab. 1 Initial weight and dilution of stock solutions

Substance	Initial weight (mg)	Final conc. stock solution (mg/mL)	Final conc. diluted solution (µg/mL)
Caffeine	99.3	9.9	99.3
Theophylline	113.2	11.3	113.2
Paracetamol	107.7	10.7	107.7

Tab. 2 Caffeine standards 1 to 5

Caffeine standard	Projected caffeine conc. (V = 1 mL) (µg/mL)	Actual caffeine conc. (V = 1.02 mL) (µg/mL)
1	5	4.9
2	20	19.5
3	40	38.9
4	60	58.4
5	80	77.8

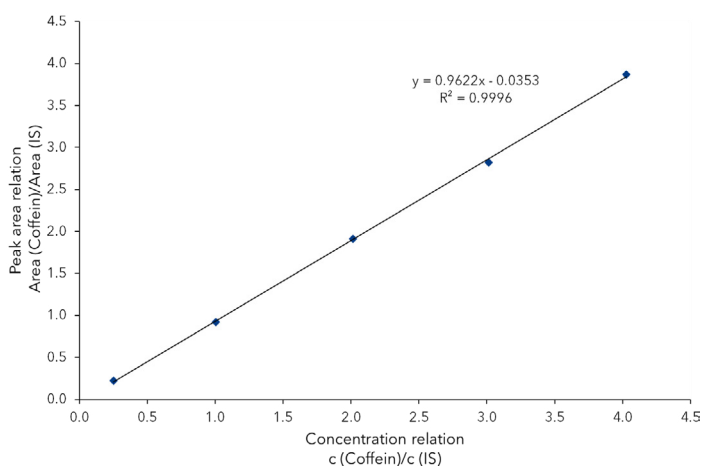

Fig. 1 Calculated ISTD calibration curve of caffeine (Mobile Control)

CALIBRATION CALCULATION SAMPLE PREPARATION

To calibrate the system, the standard solutions were injected into the system and the peak areas were analyzed. Each standard solution was injected three times to ensure sufficient data acquisition.

Depending on which software is used for the data acquisition, the calculation of calibration is different. The ClarityChrom HPLC software correlates the peak areas of the standard solutions and the peak area of the internal standard for each concentration (method: ISTD calibration curve). When Mobile Control Chrom is used, the calibration curve is generated with the help of e.g. MS Office Excel (exemplary ISTD calibration curve see **Fig. 1**). With the Mobile Control Data Viewer the peak areas can be displayed but a calibration cannot be done automatically.

A solid sample (tablet) of an analgesic product was crushed with a mortar to fine powder. Then approximately 100 mg of the homogenised sample were weighed and the weight was registered (important for quantitative analysis). The sample was then dissolved in 10 mL methanol. Thereafter, the sample was filtered through a syringe filter with a pore size of 0.45 μm . Subsequently, the filtered sample was diluted 1:100 with water. 1 mL of this solution was transferred to an appropriate vessel (vial).

Similarly, to the standard solutions, the internal standard theophylline (20 μL , final concentration approx. 20 $\mu\text{g/mL}$) was added to the sample solution. After proper mixing of the sample solution, it was ready for HPLC analysis.

INFOBOX : INTERNAL STANDARDS

In chromatography an internal standard represents a compound which is added to a sample in a known concentration. It is used to facilitate the qualitative identification and/or quantitative determination of the sample components. An internal standard must be very similar but not identical to the chemical species of the analyte. Moreover, it should not occur in the investigated sample. [1]

MATERIALS AND METHODS

The analytical parameters for determination are described in KNAUER application notes VSP0016 and VSP0017.

REFERENCES

[1] Entry: internal standard. In: IUPAC Compendium of Chemical Terminology (the "Gold Book"). doi:10.1351/goldbook.i03108.

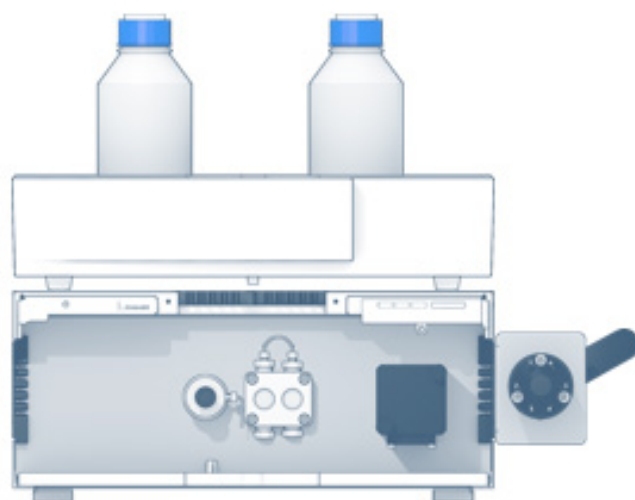

ADDITIONAL MATERIALS AND METHODS

Tab. A1 Method parameters

Eluent	Methanol:Water 40:60 (v/v)		
Gradient	isocratic		
Flow rate	0.8 mL/min	System pressure	approx. 115 bar
Column temperature	RT	Run time	5 min
Injection volume	10 µL	Injection mode	Full loop
Detection wavelength	273 nm	Data rate	20 Hz
		Time constant	0.05 s

Tab. A2 System configuration & data

Instrument	Description	Article No.
System	AZURA® Educational system	671101100
Column	Eurospher II 100-5 C18, Vertex Plus 125 x 4 mm ID with precolumn	12WE181E2J
Software	ClarityChrom 7.2 - Educational License Mobile Control Chrom	A1672-11 A9608



[AZURA® Educational system](#)

RELATED KNAUER APPLICATIONS

[VSP0016](#) - Quantification of caffeine with the AZURA® Educational system and Mobile Control Software

[VSP0017](#) - Quantification of caffeine with the AZURA® Educational system and ClarityChrom software

[VSP0019](#) - HPLC Basics - principles and parameters

KNAUER

Applications and Academy

With profound application knowledge of analytical and preparative HPLC, FPLC, SMB, and Osmometry our team is at your service around

the world. Our experts are pleased to receive your inquiries and requests, and will offer attractive customized solutions.



Application development

Proof of concept and support in selecting a HPLC / FPLC, SMB, or Osmometry method for your task

Method transfer & optimization

Transfer your methods to one of our HPLC systems or make your analyses faster, more efficient and cost effective

Rent an expert

Rent an expert for assistance in your lab

Academy

HPLC and FPLC trainings as well as specialized courses for beginners and experienced users



Not found what you are looking for?

Contact us with your requirements - together we will find a solution.

applications@knauer.net • www.knauer.net